



G200 RANGE



G200 AND G210 OPERATING MANUAL



G210

O ₂	21.1 %
N ₂ O	0.0 %
CO ₂	720ppm
CO	3ppm

Peak Store Hold



Operating Manual

Table of Contents

Manual Guidelines.....	5
Safety Related Information.....	5
Hyperlinks.....	5
Notes.....	5
Introduction.....	6
The G200 Analyser.....	6
The G210 Analyser.....	7
Instrument Components - Standard Product.....	8
G200 Range Optional Products and Accessories.....	9
Optional Products.....	9
Analyser Data Manager (Optional).....	9
Event Log.....	9
Carbon Monoxide Reading (Optional – Enhancement for G210 ONLY).....	9
Oxygen Reading (Optional – Enhancement for G210 ONLY).....	10
Pressure Regulator (Optional - G210 ONLY).....	10
Soda Lime CO ₂ Filter.....	10
Assembly and connection.....	11
Instrument Accessory Products.....	12
Instrument Features.....	13
Physical Characteristics of the Instrument Panel.....	13
Panel Key Functions.....	14
Instrument Connection Points.....	15
General Operational Instructions.....	16
Switching the Instrument On.....	16
Switching the Instrument Off.....	16
Entering Data.....	16
Numeric Data.....	16
Alpha-numeric Data.....	17
Instrument Status Icons.....	17
Changing Between Parameters.....	18
Memory.....	18
Storage.....	18
Warning and Error Codes.....	18

Operating Manual

Battery/Charging.....	18
Instrument Main Read Screen	19
Soft-Keys	19
Alternative Reading Methods	19
Peak Reading.....	19
Store Reading.....	20
Hold Reading.....	20
Logged Reading:.....	20
Enter ID Codes	20
Soft-Keys	21
Main Menu	21
Information	22
Utilities	22
Calibration.....	28
View Data.....	28
Diagnostics.....	30
Monitor (G200 ONLY).....	30
Taking Readings.....	35
Preliminary Checks - Best Practice.....	35
G200 Gas Measurement Process – Best Practice	36
G210 Gas Measurement Process – Best Practice	37
Calibration	39
User Calibration	39
Calibration Gases	39
Calibration Set-up	39
Calibration Equipment.....	40
Calibration Method.....	41
Zero Calibration.....	41
Span Channels.....	42
Last Field Calibration.....	42
Calibration Record	42
Recommended Gases for Calibration	43
G200 Range Calibration – Best Practice.....	44
Problem Solving.....	45

Operating Manual

Warnings and Errors	45
Under and Over Range Codes	45
Self-test Warning Messages.....	46
User Calibration Trouble Shooting.....	48
User Calibration Explained:	48
Cross-Gas Effects	50
CO ₂ Cell	50
O ₂ Cell	50
N ₂ O Cell.....	50
CO Cell.....	50
Hardware Reset	50
Service	52
User Serviceable Parts	52
Cleaning	52
Warranty Policy	53
Event Log.....	55
WEEE Compliance	56
EU Declaration of Conformity.....	57
Glossary of Terms.....	58

MANUAL GUIDELINES

Safety Related Information



Information in this manual that may affect the safety of users and others will be in a box identical to this one.

Failure to follow this information may result in physical injury which in some cases could be fatal.

Hyperlinks

Hyperlinks to other sections of this manual, websites or email addresses are in the following format:

www.geotechuk.com

Notes

Important/useful information and instructions are shown clearly throughout the manual in a note format.

For example:

Note: For further information please contact Technical Support at QED on +44(0)333 800 0088 or email technical@qedenv.co.uk.

INTRODUCTION

This manual explains how to use the instrument model types listed below:

- G200 N2O 0-1,000ppm (plus 10,000 range low resolution)
- G210 N2O 0-100%+CO2 0-2,000ppm+O2 0-100%+CO 0-500ppm

Both units have been developed to incorporate the latest technology and specification requirements, which provide the user with a fast, simple-to-use and accurate piece of monitoring instrumentation.

Note: These instruments are sensitive pieces of scientific equipment, and should be treated as such.



If the equipment is used in a manner not specified by the manufacturer, the protection provided by the equipment may be impaired.

The G200 Analyser



The G200 analyser is specifically designed to safety check background zone levels of N₂O (0-1,000ppm) in medical applications. This instrument measures the long term exposure to N₂O gas along with the TWA (time weighted average), leak detection for N₂O storage. It is a dual purpose background analyser or personal analyser and is highly portable.

The G200 analyser has the following features:

- O₂, N₂O 0-1,000ppm
- Data storage for 1,000 readings and download

Operating Manual

- EH40 occupational exposure limits calculated (TWA) – applicable to the UK only
- Leak detection
- User settable alarms
- Data download for graphing and reporting
- Four modes of operation: personal safety - TWA 8 hour read back; room monitor – background levels, user defined times; leak mode – 1-10,000ppm fast response; and standard measuring.

The G210 Analyser



The G210 analyser is specifically designed for highly accurate measurement and verification of the quality of piped N₂O and O₂ gases in hospitals. This instrument enables up to four gases to be measured, easy user calibration, quick verification of gas quality, user maintained site and sample point IDs for monitoring as well as identification of contaminants CO and CO₂.

The analyser has the following features:

- N₂O 0-100%
- O₂ 0-100% (optional)
- CO 0-500ppm (optional)
- CO₂ 0-2,000ppm
- Data storage with site and ID input
- Data download for graphing and reporting

Instrument Components - Standard Product



Reference:

- A) Analyser
- B) Mains Battery Charger
- C) Mains Battery Charger Adaptors:
 - Europe
 - US
 - Australia
- D) Soda Lime CO₂ Filter (G200 Only)
- E) Operating Manual

G200 RANGE OPTIONAL PRODUCTS AND ACCESSORIES

Optional Products

The G200 analyser range has a number of optional products for purchase which enhance the usability and enable further analysis of data and reading information.

Note: For more information on the features listed in this section please contact Sales at QED on +44(0)333 800 0088 or email sales@qedenv.co.uk.

Analyser Data Manager (Optional)

Analyser Data Manager software application enables the operator to maximise the operation of the analyser by providing the ability to:

- Obtain instrument status.
- View the instrument readings and event log data.
- Download and store readings for further analysis.
- Graph downloaded instrument readings.
- View, import and export the instrument configuration.
- Update the instrument's firmware.
- Copy data from the G200 Client into other packages such as MS Excel.
- Email data directly from the application.
- Configure remote access to a central database.
- Print graph and tabular data.

Event Log

The G200 range of instruments incorporates the facility to log significant events via the 'Event Log'. This can be used as an aid to monitoring the use of the instrument. It can also be used as a diagnostic tool if there is a problem with the instrument.

The event log can only be viewed via the optional Analyser Data Manager software. It cannot be viewed on the analyser screen. Applicable events are stored in the event log automatically. No user intervention is required.

The event log can hold approximately 270 events. If the log becomes full then it begins to overwrite the older events. This can be identified by the index field which starts from event number 1. The log is cleared when the instrument is reset.

Note: Please refer to section [Event Log](#) of this operating manual for further information.

Carbon Monoxide Reading (Optional – Enhancement for G210 ONLY)

The G210 instrument has the optional facility to use an internal CO cell (specified at the time of manufacture or upon request at service interval). This allows the instrument to read and display carbon monoxide readings along with N₂O.

Operating Manual

Oxygen Reading (Optional – Enhancement for G210 ONLY)

The G210 instrument has the optional facility to use an internal oxygen cell (specified at the time of manufacture or upon request at service interval). This allows the instrument to read and display oxygen readings along with N₂O, CO₂, CO.

Pressure Regulator (Optional - G210 ONLY)

A pressure regulator must be used when taking gas readings to restrict the flow into the instrument when using the G210 analyser. When sampling piped medical gases the pressure of the gas needs to be reduced before it is passed to the instrument. This reduces the pressure to 100mbar suitable for the instrument.

Note: Alternative methods of pressure reduction are available and could be used. However, to avoid irreversible damage to the instrument, please seek guidance from the supplier / manufacturer before using any other pressure device.



Do NOT use the instrument at full piped pressure (maximum pressure 300mbar).

Soda Lime CO₂ Filter

The G200 instrument must only be used with a soda lime CO₂ filter attached. The filter removes CO₂ if present when a reading is taken.

This filter should always be fitted when using a G200 instrument as any CO₂ will cross-contaminate the N₂O reading. For further information please refer to section [Cross-Gas Effects](#).

The life of the filter will vary depending on usage. The crystals change colour from pale green-blue to white-grey. The filter element should be discarded when a significant percentage of the crystals start to turn a white-grey colour see below:-



Figure 1 - New filter (pale green/blue)

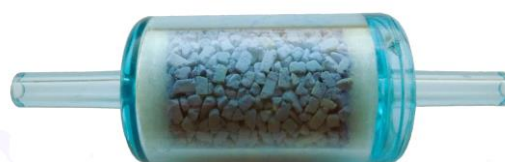

Figure 2 - Used filter (white/grey)

Assembly and connection

The filters are supplied in a sealed storage bag to improve their shelf life. The parts supplied should be assembled as per the diagram shown.

Note: A soda lime CO₂ filter can also be used to zero other G Range instruments.



Instrument Accessory Products

Optional accessory and replacement parts may be purchased for the G200 range from QED direct. Please refer to the website www.gedenv.co.uk for further details on pricing and how to order.



Ref	Description	Part Number
A	USB Lead	USBLEAD2
B	Spare Sample Filters (pack of 5)	068296/S
C	Sample Tube Kit	G1.6
D	Hard Carry Case	050227
E	Spare Calibration Gas (Various gas options available)	CDA7.6
F	Mains Charger including Worldwide Adaptors	2008248/S
G	Soft Carry Case	G1.11
H	Soda Lime Filter Kit	G1.10
I	Analyser Data Manager Software	G1.4
K	Regulator and Tubing for Calibration Gas	G1.1

INSTRUMENT FEATURES

Physical Characteristics of the Instrument Panel

Front View:



Reference:

- A) Main Read Screen
- B) Soft keys
- C) On/Off key
- D) Pump key
- E) Key 4 – scroll left
- F) Key 8 – scroll down
- G) Menu key
- H) Enter key
- I) Key 2 – scroll up
- J) Key 6 – scroll right

Back View:



Reference:

- L) Serial number
- M) Instrument stand

Panel Key Functions		
Key	Description	Function
A	Main Read Screen	Start and end screen when using the instrument.
B	Soft Keys	The function of the three 'soft-keys' on the front of the instrument panel are determined by menu options taken. Functions vary from screen to screen.
C	On/Off Key	Press the 'On/Off' key briefly to switch the instrument on and off.
D	Pump Key	Press the 'Pump' key to start or stop the pump.
E	Scroll Left Key	Also 'Key 4'. Enables the operator to scroll left to display more information.
F	Scroll Down Key	Also 'Key 8'. Enables the operator to scroll down to display more information.
G	Menu Key	Press the 'Menu' key to go to the 'Main' menu. Enables the operator to pre-set values and settings. Select options from the 'Main' menu to also view data and readings stored or held.
H	Enter Key	The 'Enter' key accepts/confirms choices made by the operator to various functions and operations. Also, required to confirm numeric data entry.
I	Scroll Up Key	Also 'Key 2'. Press scroll up to view further information on the instrument read screen.
J	Scroll Right Key	Also 'Key 6'. Press scroll right to view further information on the instrument read screen.
L	Serial Number	Unique Identification for the instrument. Verification of the serial number will be required if Technical Support assistance is needed.
M	Instrument Stand	Instrument stand.

Instrument Connection Points

Top View:

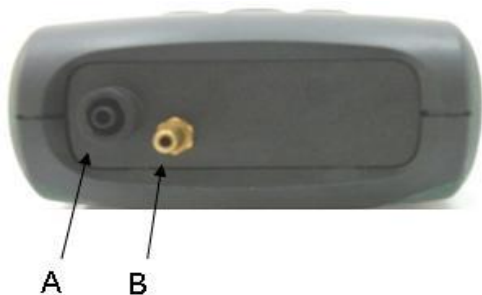

Side View:



Key	Description	Function
A	Gas Inlet	Gas inlet point used to attach the sample tube and filter in order to take the gas reading
B	Gas Outlet	Gas outlet port used to exhaust the gas
C	USB Port	Used to connect the analyser to a PC via a USB cable to download data
D	Charger Port	Used to attach the main charger to the analyser for charging

5V ± 0.5V(max 1000mA)

GENERAL OPERATIONAL INSTRUCTIONS

Note: Fully charge the unit before use when the instrument is first received or if the instrument has been in storage for six months or more.

Switching the Instrument On

- 1) To switch on the instrument, press the 'On/Off' key briefly. There will be a short beep and a slight pause followed by the Geotech logo.
- 2) The power on self-test will commence.
- 3) Assuming there are no warnings to display the instrument will continue to the 'Main Read Screen'.

Switching the Instrument Off

- 1) Purge with fresh air. Run the pump for approximately 30 seconds or until the readings have returned to normal levels.

Note: Before the instrument is switched off a clean air purge should be performed. This ensures that the instrument is free from gas and ready for the next measurement. This final purge is especially important for the oxygen sensor as it may degrade if stored when contaminated with gas.

- 2) To switch off the instrument, press the 'On/Off' key briefly.

Note: If the 'Auto Off' utilities setting is set to 'Yes', the analyser will switch off automatically after ten minutes if not in use.

Entering Data

During normal operation the user may be prompted to enter data or information via the keypad, i.e. entering an ID code or setting an alarm level.

When entering data into the instrument all fields are fixed format and are populated from the right.

Numeric Data

To enter a new time 09:25:00 the user would type in 092500 using the numeric keypad in the following sequence:-

* __:__:0

* __:__:09

* __:0:92

* __:09:25

*_0:92:50

* 09:25:00

Press the 'Enter' key to confirm/accept data keyed.

Operating Manual

Any mistakes can be corrected using the soft-key 'Delete' which will delete the last digit typed. Alternatively, the sequence can be retyped before the 'Enter' key is pressed and the existing numbers will be pushed off the screen.

Alpha-numeric Data

When entering site IDs, alpha-numeric codes may be specified. To enter characters select either '1-Site' or '2-ID' followed by the 'Menu' key and the following screen is displayed:



Screen 1 – Enter site

The operator can choose upper and lowercase characters. Press the 'Menu' key again to choose lowercase characters. Use the numeric keypad on the instrument to select the appropriate letter, i.e. to select A 'Key 2', to select B 'Key 2' twice (just like on a mobile phone).

Note: The instrument will not allow invalid data to be entered; this should be deleted and re-entered.

Instrument Status Icons

The following icons may be displayed on the instrument read screens:

Icon	Description
	Battery charge state
	< 1 hour remaining
	Battery charging
	Charged
	Pump running
	Pump stalled (Backlight turns red)
	Alarm set
	Alarm active (Backlight turns red)
	USB connected to PC (flickers when transferring data)
	Logging mode active (flashes when memory nearly full)
	Temperature probe(s) connected
	Humidity probe connected
	Service due (every 12 months)
	Service overdue
	Fault/repair
	Waiting

Note: A red backlight is displayed if the pump is stalled or the alarm is activated. For further

Operating Manual

information, please refer to section [Alarms](#) or [Flow Fail](#).

Changing Between Parameters

By default, the instrument displays the 'Main Read Screen' (for gas measurement). The instrument will return to this screen after power on or when returning from the menus. The 'Scroll' keys can be used to switch to another measurement screen. Continue to press the 'Scroll' keys to return to the 'Main Read Screen'.

Memory

The memory should not be used as a permanent storage medium and any important data should be transferred to a more permanent storage medium as soon as possible. The instrument should not be stored for prolonged periods with valuable data in its memory.

Storage

When not in use the instrument should be kept in a clean, dry and warm environment, such as an office. It should be stored flat with the stand folded away which helps prolong the life of the O₂ cell.

Warning and Error Codes

When switched on the instrument will perform a predetermined self-test sequence taking approximately ten seconds. During this time many of the instrument's working parameters and settings are checked. If any operational parameters are out of specification or if the pre-programmed recommended calibration/service date has passed, errors or warnings may be displayed.

Note: For further information please refer to section [Problem Solving](#).

Battery/Charging

Note: Fully charge the unit before use when the instrument is first received or if the instrument has been in storage for six months or more.

The battery used in the instrument is a 2.6 Ah Lithium-Ion cell. The instrument must be charged using the power supply supplied with your instrument. The power supply supplied is intended for indoor use only. Please ensure adequate ventilation whilst charging.

Note: The instrument cannot be powered or charged via the USB connector.

Note: When plugged into the power supply the instrument will power on and display charging. When complete the display will change to show that the instrument is charged. To switch the instrument ON whilst charging or charged is displayed, the operator will need to press and hold the power key briefly.

Note: Once the instrument is fully charged, the power supply should be disconnected from the instrument.

Operating Manual

Instrument: Input: 5Vdc \pm 0.5V (max 1000mA)

Power Supply: Input: 100 -240Vac 60/50Hz 120mA

Output: 5Vdc 1000mA (5VA)



Note: A full charge will take approximately **4 hours**. Typically, a fully charged battery will last 10-12 hours.

When the instrument is already powered on, the operation is slightly different as the battery icon changes to a flashing plug symbol. This will stop flashing when the charge is complete.

Instrument Main Read Screen

After the analyser has been switched on and the warm-up self-tests completed the analyser will display the following screen.

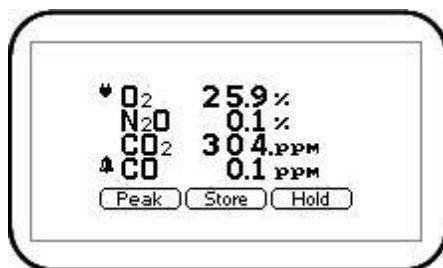

Screen 2 - Main readings

Soft-Keys

- Peak - Enables the operator to display the peak reading.
- Store - Enables the operator to store the reading for viewing/download later.
- Hold - Enables the operator to hold the current reading being taken.

Alternative Reading Methods

The G210 has three reading types or methods which each require slightly different operating procedures:

- Peak reading
- Store reading
- Hold reading
- Logged reading

Peak Reading

The operator can toggle the reading mode between normal (current) and peak readings. Whilst in peak reading mode the instrument will only display peak values for each of the channels. These values can then be stored by pressing the 'Store' key or automatically at the appropriate logging

interval (if logging is enabled).

The peak value is reset after a reading is stored or by exiting the peak mode using the appropriate soft-key. The current mode of operation can be identified by the status of the soft-key, either 'Normal' or 'Inverse', where inverse indicates peak mode is active.

Store Reading

The 'Store' reading option allows the operator to store the current reading. Upon selecting this option the operator is then prompted to enter or select a 'Site ID' and 'Sample Point ID' to identify the reading. Select the 'Accept' button to confirm the ID choices. For further information please refer to section [Enter ID Codes](#).

Hold Reading

The 'Hold' reading option allows the operator to freeze the currently displayed reading. This allows it to be manually recorded or moved away from the sample point. Once activated, press the soft-key 'Hold' and the readings are fixed until the 'Hold' key is pressed again or the reading is stored.

The current mode of operation can be identified by the status of the soft-key which is inverted whilst in the hold phase.

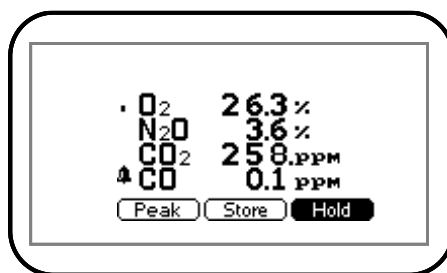

Screen 3 - Hold reading

Logged Reading:

Logged readings need to be configured and initiated via the 'Utilities' menu by pressing 'Key 6 - Logging'. During configuration the user will be asked to supply an ID, reading interval and pump run-time.

These parameters are used to control the reading frequency in logging mode. Once logging mode is activated the instrument will automatically record a reading at every interval until stopped by the operator or the memory becomes full. Logging is also suspended temporarily whilst the user is accessing the menu options.

Whilst the logging mode is active both the 'Pump' and 'Store' key will be deactivated; only logged readings can be stored.

Enter ID Codes

ID codes are either created at the time of selection on the analyser or created using the Analyser Data Manager software and uploaded to the instrument for selection prior to readings being taken.

The 'Site' (top level ID) and 'ID' (second level ID) fields refer to the identifier that the operator gives to a reading set before it is stored. The G200 and G210 allows the operator to enter up to 16 alpha-numeric characters which are split into two parts (to help manage the data) called 'Site' and 'ID' by

Operating Manual

default. These are entered as two sets of eight alpha-numeric identifiers by the operator (i.e. typed in). For example, the first part called 'Site' can be used to store the name of the building i.e. 'Warwick' and the second part called 'ID' could be used for location or room where the reading was taken, i.e. 'A&E1'.

It is possible using Analyser Data Manager to change the name of these fields as displayed on the instrument from 'Site' and 'ID' to something else up to seven characters, i.e. 'ward' and 'bed', depending on the application or typical mode of operation.



Screen 4 - Enter site ID

Soft-Keys

Delete – Enables the operator to backspace delete digits keyed in the 'Enter Site' field.

Find – Enables the operator to search and find pre-stored IDs.

Exit – Enables the operator to exit the 'Enter Site ID' screen and return to the 'Main Read Screen'.

Main Menu

The 'Main Menu' enables the operator to select options to set up specific parameters and perform operational tasks prior to sample readings being taken or to view data and information stored in the instrument.

Note: Unless otherwise stated the functions and menus are the same for both the G200 and G210 instrument.

- 1) Press the 'Menu' key on the front of the instrument panel and the following screen is displayed:

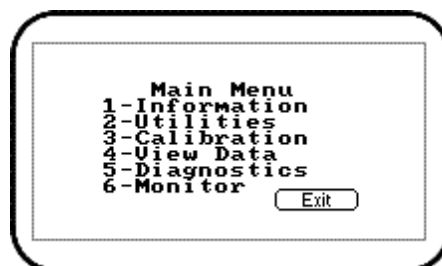

Screen 5 - Main menu

- 2) Press the soft-key 'Exit' to exit the 'Main' menu.

Operating Manual

Information

The 'Information' option enables the operator to display information such as instrument type, serial number, current software version, service due date and the dates of the last factory and user calibrations.

- 1) From the 'Main Read Screen' press the 'Menu' key on the instrument panel.
- 2) Press 'Key 1' to display general information about the instrument.

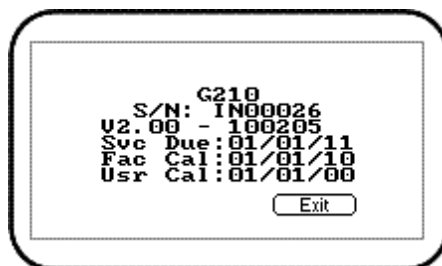

Screen 6 - Information

Utilities

The 'Utilities' option enables the operator to configure instrument settings prior to taking readings.

- 1) From the 'Main Read Screen' press the 'Menu' key on the instrument panel.
- 2) Press 'Key 2' to display the 'Utilities' menu and the following screen is displayed:

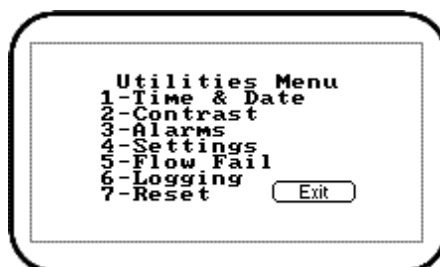

Screen 7 - G210 utilities menu

Time & Date

The 'Time & Date' option enables the operator to check or set the instrument's internal clock. The current time/date are appended to every stored reading.

- 1) From the 'Main Read Screen' press the 'Menu' key on the instrument panel.
- 2) Press 'Key 2' to display the 'Utilities' menu.
- 3) Press 'Key 1' and the 'Set Time & Date' menu is displayed:



Screen 8 - Set time & date

- 4) Press 'Key 1' to change the time or press 'Key 2' to change the date. Type the time or date using the numeric keypad followed by the 'Enter' key. The instrument will not allow invalid times or dates to be entered.

Note: The clock will need to be manually adjusted to cope with daylight saving changes or changes when crossing time zones.

Contrast

The 'Contrast' option enables the operator to adjust the instrument screen contrast to compensate for changes in ambient temperature. The default setting is 0.

- 1) From the 'Main Read Screen' press the 'Menu' key on the instrument panel.
- 2) Press 'Key 2' to display the 'Utilities' menu.
- 3) Press 'Key 2' to select the instrument panel contrast settings and the following screen is displayed:

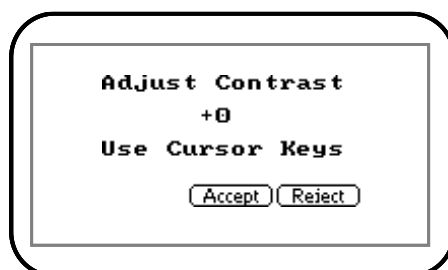

Screen 9 - Adjust contrast

- 4) Press 'Key 3 - Scroll Left' and 'Key 6 - Scroll Right' to adjust the value displayed.
- 5) Press the soft-key 'Accept' or 'Reject' accordingly to accept or reject the changes.

Note: The manually set contrast setting is retained when the instrument is switched off.

Alarms

The G200 range of instruments has the facility to set rising or falling alarms for the main gas channels. The alarms for each channel can be enabled or disabled independently via the 'Alarms' menu option.

Operating Manual

Once enabled these alarms become active in the 'Main Read Screen'; this is indicated by a bell 🛎 icon. If an alarm is triggered the screen turns red and a flashing bell 🛎 icon is displayed. The beeper is sounded until the gas level has recovered beyond the trigger point.

- Rising alarms are triggered when the gas level exceeds the maximum value entered by the user.
 - Falling alarms are triggered when the gas level falls below the minimum value entered by the user.
- 1) From the 'Main Read Screen' press the 'Menu' key on the instrument panel.
 - 2) Press 'Key 2' to display the 'Utilities' menu.
 - 3) Press 'Key 3' to select 'Alarms' and the following screen is displayed:

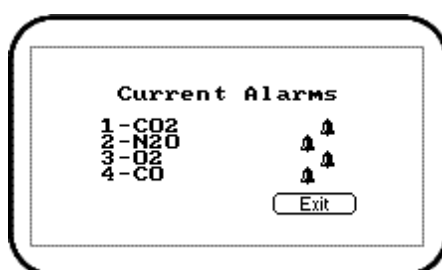

Screen 10 - Current Alarms (G210)

- 4) Press the appropriate key/option number to maintain the alarm settings. Select from the following:
 - 1 – Enabled/Disabled: Toggle between disabled and enabled alarm status.
 - 2 – Max: Sets the upper limit alarm setting.
 - 3 – Min: Sets the minimum alarm setting. The default is 0.
- 5) Select the option key to modify followed by the soft-key 'Accept' or 'Reject'.

Settings

The 'Settings' option enables the operator to maintain information with regards to taking samples and readings.

- 1) From the 'Main Read Screen' press the 'Menu' key on the instrument panel.
- 2) Press 'Key 2' to display the 'Utilities' menu.
- 3) Press 'Key 4' to select 'Settings' and the following screen is displayed:

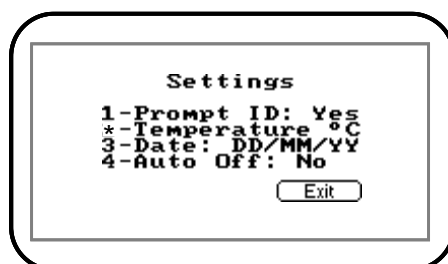

Screen 11 - Settings

- 4) The following instrument settings may be maintained:
- 1 – Prompt ID: Press 'Key 1' to prompt for ID code for each sample reading, answer 'Yes' or 'No' accordingly.
 - * – Temperature: This option is not available on the G200 range of instruments.
 - 3 – Date: Press 'Key 3' to switch the date format between dd/mm/yy and mm/dd/yy formats.
 - 4 – Auto Off: Press 'Key 4' to auto switch off the instrument when not in use. Toggle between Auto Off: Yes or No. If set to Yes, the instrument will switch off after ten minutes if not in use.

Flow Fail

The 'Flow Fail' option enables the operator to adjust the instrument flow fail detection point should it fail in normal operation with a clean filter.

The instrument's internal pump can be stalled when pulling against a vacuum or through a blocked filter. This is indicated by a flashing pump icon ; to prevent damage to the pump, the pump will switch off after a few seconds. Press the 'Pump' key again to remove the flashing pump icon.

Note: Dirty or discoloured filters should be changed before use. Filters that have drawn in water should be changed immediately to prevent damage to the instrument.

- 1) From the 'Main Read Screen' press the 'Menu' key on the instrument panel.
- 2) Press 'Key 2' to display the 'Utilities' menu.
- 3) Press 'Key' 5 to select 'Flow Fail' and the following screen is displayed:

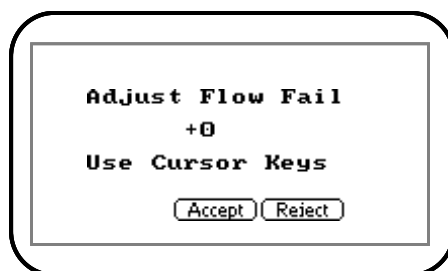

Screen 12 - Adjust flow fail

Operating Manual

- 4) Use the scroll keys 'Key 4 – Scroll Left' or 'Key 6 – Scroll Right' to adjust the value displayed. The larger the value, the less sensitive the flow fail detection is.
- 5) Press soft-key 'Accept' or 'Reject' accordingly.

Flow Fail Set-up Process – Best Practice:

Make sure that you have carried out the Preliminary Checks Best Practice before commencing the Flow Fail Set-up. Refer to section [Preliminary Checks - Best Practice](#) for more information.

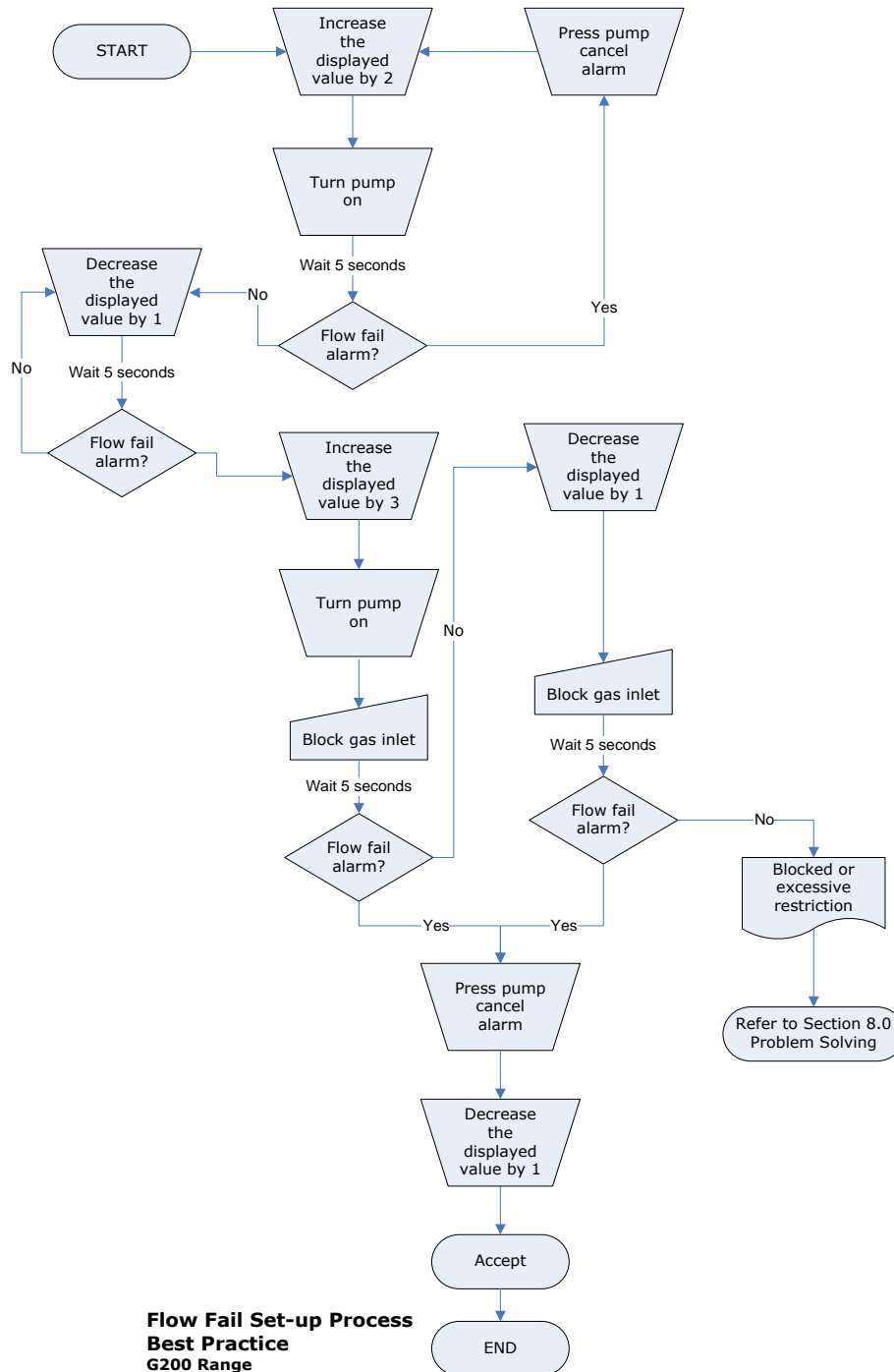

Operating Manual

Logging

Data logging mode can be started or stopped via 'Key 6 - Logging' accessed from the 'Utilities' menu. Press 'Key 4 – Start/Stop Logging' to start and stop data logging.

Whilst in data logging mode the instrument will automatically record data at the preset intervals, including running the pump for a preset time.

Active logging mode is indicated on the 'Main Read Screen' by the  icon.

The operator is able to edit the default ID, pump run-time interval, set IDs and start/stop logging.

- 1) From the 'Main Read Screen' press the 'Menu' key on the instrument panel.
- 2) Press 'Key 6' to display the 'Logging' menu and the following screen is displayed:

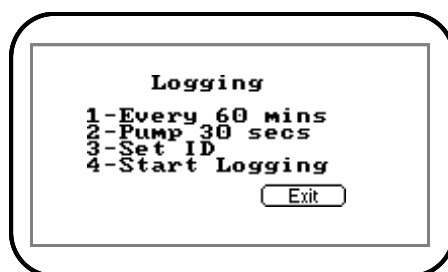

Screen 13 - Logging menu

- 3) Select the desired option by pressing 'Keys 1 to 4'. Then enter the appropriate setting using the keypad followed by the 'Enter' key.
 - 1 – Every 00 Mins: Press 'Key 1' to enter the time in minutes for the time frame between sample readings. The interval controls the reading frequency in minutes, i.e. every ten minutes.
 - 2 – Pump 00 secs: Press 'Key 2' to enter the time in seconds for the length of time you wish the pump to run when taking a sample reading. The pump run-time is the time in seconds for which the pump runs prior to the reading being stored. This figure will also need to take into account the length of sample tube and the volume of the sample gas. For example, there is little point setting a pump run-time of ten seconds if it takes 30 seconds to draw in a new sample.
 - 3 – Set ID: Press 'Key 3' to create eight digit alpha-numeric 'Site' and 'ID' identifiers.
 - 4 – Start/Stop Logging: This option is only available once an I.D. has been created by the user. Press 'Key 4' to start and stop data logging.

Note: Data logging mode is automatically stopped when the instrument is switched off or if the logging parameters are edited.

Reset

The instrument can be reset by pressing 'Key 7 - Reset' accessed via the 'Utilities' menu. Selecting this option will clear all user settings and any stored data including the event log.

The following warning message will be displayed 'This will clear user calibration and readings! Are you sure?' The operator is prompted to either select the 'Accept' button to continue or select the 'Exit' button to abort the reset operation.

If the operator chooses to accept a confirmation code (12345678) must be entered to confirm that a reset is really required.

Calibration

The G200 range of instruments is fully calibrated during manufacture and when returned for service. However, to improve accuracy between services a user/field calibration can be performed.

Note: For further information please refer to section [Calibration](#) of this manual.

View Data

The 'View Data' option enables the operator to view the stored readings.

- 1) From the 'Main Read Screen' press the 'Menu' key on the instrument panel.
- 2) Press 'Key 4 - View Data' to view the stored data readings and the following screens are displayed:

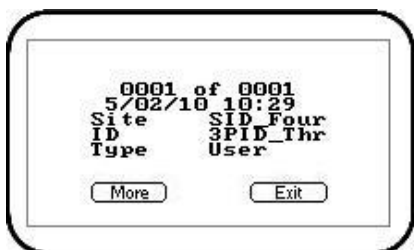

Screen 14 - View data 1

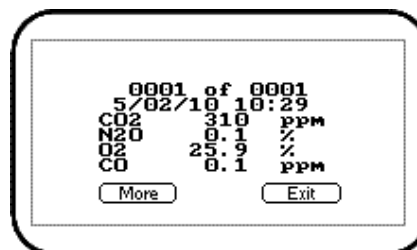

Screen 15 - View data 2

- 3) Press 'Key 4 - Scroll Left' and 'Key 6 - Scroll Right' to move through the stored readings either forwards or backwards. Press 'Key 2 - Scroll Up' and 'Key 8 - Scroll Down' to switch between the first and second group of reading parameters.
- 4) Press the soft-key 'More' and the following menu is displayed:

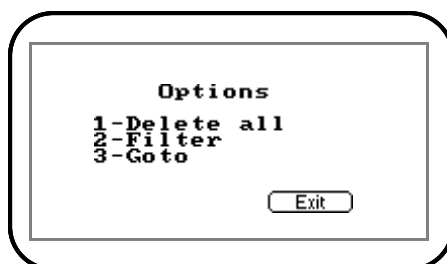

Screen 16 - Soft-key 'More'

Operating Manual

- 1 – Delete All: Enables the operator to delete all the readings stored,
- 2 – Filter: Used to refine/filter the range of readings displayed by ID or date ranges. Press between two dates, after a date, before a date or all dates.
- 3 – Go to: Enables the operator to jump to the first or last reading in the memory or any other reading.

Delete All

The 'Delete All' function enables the user to check how many readings have previously been taken and clear them if necessary.

Note: Before readings are actually deleted a caution message is displayed; once readings have been deleted they cannot be recovered. To enable TWA to be calculated the last 24 hrs worth of readings are stored.

The instrument can store up to 1,000 readings. The reading structure is fixed and may contain optional parameters not activated for your particular instrument configuration, i.e. oxygen, temperature and humidity.

Once the reading memory is full it is not possible to store any more readings. When full and the 'Store' key is pressed or data logging is activated the instrument will show a brief message stating that the memory is full and that no further data will be recorded.

- 1) From the 'Main Read Screen' press the 'Menu' key on the instrument panel.
- 2) Press 'Key 4 - View Data'.
- 3) To clear the readings press the soft-key 'More' followed by 'Key 1 - Delete all'.

Filter

The 'Filter' function enables the user to filter the data readings using all or any combination of the following filter options:

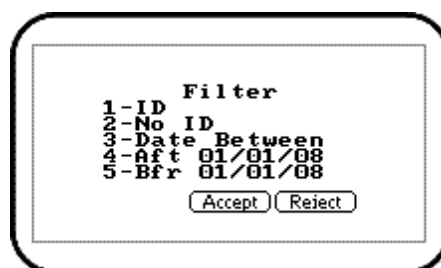

Screen 17 - Filter

- 4) From the 'Main Read Screen' press the 'Menu' key on the instrument panel.
- 5) Press 'Key 4 - View Data'.
- 6) To clear the readings press the soft-key 'More' followed by 'Key 2 - Filter'.

- 7) Press the appropriate menu key to select the required filter option and enter the filter data.
- 8) Select the 'Accept' button to confirm the filter selection.

Go to

The 'Go to' function enables the operator to view the first, last or specific number of reading stored.

- 1) From the 'Main Read Screen' press the 'Menu' key on the instrument panel.
- 2) Press 'Key 4 - View Data'.
- 3) To clear the readings press the soft-key 'More' followed by 'Key 3 - Goto'.
- 4) Select either 'First', 'Last' or 'Num'. If 'First' or 'Last' is selected the appropriate data will be displayed.
- 5) If 'Num' is selected the operator is prompted to enter the data reading number followed by the 'Accept' button to confirm the selection.

Diagnostics

The 'Diagnostics' option enables QED Technical Support to identify and resolve issues with the instrument and readings. If required, the operator may be asked to confirm the diagnostics displayed.

- 1) From the 'Main Read Screen' press the 'Menu' key on the instrument panel.
- 2) Press 'Key 5' to view diagnostics.

Note: For further information contact Technical Support at QED on +44(0)330 800 0088 or email technical@qedenv.co.uk.

Monitor (G200 ONLY)

The 'Monitor' option enables the operator of a G200 instrument to choose from the following three monitoring modes.

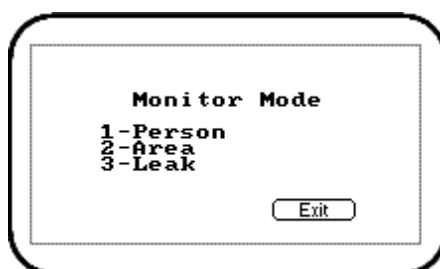

Screen 18 - Monitor mode

- 3) From the 'Main Read Screen' press the 'Menu' key on the instrument panel.
- 4) Press 'Key 6' followed by the relevant option key to select the required monitoring mode.

Operating Manual

Person

'Person' enables the operator to monitor in personal safety mode. This mode automatically stores an average N₂O reading every 15 minutes. This is used to calculate and display an eight hour TWA (time weighted average) reading which is the operator's personal exposure level to N₂O over their working day (often called OEL - occupational exposure limit).

The TWA is measured over a 24 hour period.

The TWA calculation used by the instrument is that described by the Health and Safety Executive EH40/2002 Occupational Exposure Limits 2002. The TWA is represented mathematically by the following equation:

$$(C_1T_1 + C_2T_2 \dots C_nT_n) / 8\text{hrs.}$$

Where C₁ is the average reading for the time period T₁.

In this mode the instrument will alarm when the operator has exceeded the recommended TWA limit (the OEL for N₂O = 100ppm). This operating mode incorporates a confidence chirp which sounds every 30 seconds to give the operator confidence that the monitor is still operating correctly. There is also an option which allows the operator to set an additional alarm for the actual N₂O level, i.e. greater than 300ppm.

It is possible using Analyser Data Manager to change the OEL level for the TWA limit (default 100ppm). We would also recommend that the operator changes the 'Site' and 'ID' fields to 'Site' and 'Name' using the 'Configuration' tab.

Once IDs have been selected and accepted, readings commence immediately and are monitored continuously. To stop monitoring the operator selects the soft-key 'Person', enters the stop code 5709 and presses the 'Enter' key. Readings are automatically stored.

The following points should be noted.

- 1) The 15 minutes averages used for the TWA calculation are the result of readings taken each second. Thus short peaks of concentration will be correctly recorded and added into the TWA
- 2) If the instrument is turned off when in 'Person' mode, the readings will be assumed to be zero for the TWA calculation during the time when the instrument is off.
- 3) The TWA value displayed on the instrument is not downloaded to Analyser Data Manager (ADM). ADM recalculates the TWA based on the downloaded raw data and user set parameters.

Area:

'Area' enables the operator to monitor in area or room mode. This mode automatically stores a rolling average N₂O reading every 'n' minute(s). It is indicated by 'AV' on the screen.

The calculation is represented mathematically by the following equation: $(C_1 + C_2 \dots C_n) / \text{elapsed time in hrs.}$

This mode would typically be used to monitor a ventilation system in an operating theatre or similar where N₂O is used throughout the day with different people coming and going. Primarily for room or area monitoring, this mode is intended to give the operator a little more flexibility and can be user modified to suit the application. The monitoring interval and duration can be adjusted by the operator. There are alarm options which allow the operator to set an alarm for the average and

Operating Manual

actual N₂O levels, eg greater than 300ppm.

As with previous modes it is possible using Analyser Data Manager to change the 'Site' and 'ID' fields to 'Site' and 'Room or Area' using the 'Configuration' tab.

Once IDs have been selected and accepted, readings commence immediately and are monitored continuously. To stop monitoring the operator selects the soft-key 'Area', enters the stop code 5709 and presses the 'Enter' key. Readings are automatically stored.

Leak Detection:

'Leak' enables the operator to monitor the instrument in leak detection mode. This extends the range of the N₂O sensor up to 10,000ppm and speeds up the response time to enable it to indicate the current level of N₂O. This allows the instrument to work as an effective leak monitor. The operator gets audio and visual feedback in addition to the displayed value to help with this. The back-light changes from green-thru-yellow to red as the gas concentration increases. And the instrument's beeper also increases in frequency and tone to further help bring attention to any gas detected. There are no additional user alarms or setting for this mode. It is not possible to store data whilst in this mode.

The operator starts and stops monitoring by selecting the soft-key 'Leak'.

Note: When monitoring gases using any of the above methods the 'Mute' key may be activated to eliminate the instrument monitoring sound.

TWA and Average Calculations in ADM

This section explains how the Average and Time Weighted Average (TWA) calculations work with the Analyser Data Manager (ADM) software.

The following parameters are optionally calculated by ADM and use the set of data currently selected in ADM by the ID, time filters and serial number selection.

Average (ppm)

Average (ppm) = (AvgN₂O₁ x AvgPeriod₁ + AvgN₂O₂ x AvgPeriod₂ + AvgN₂O_n x AvgPeriod_n) / number-of-minutes from first to current filtered reading.

Note: The results in this column may change when the filter(s) are changed.

Note: The definition of the parameters of the calculation can be altered within ADM on the Configuration tab.

TWA (ppm)

TWA (ppm)_{_} = (AvgN₂O₁ x AvgPeriod₁ + AvgN₂O₂ x AvgPeriod₂ + AvgN₂O_n x AvgPeriod_n) / 8 hours. The data is taken as a 24 hour window extending backward through the filtered entries.

Any missing entries within the 24hr window are assumed to be 0ppm.

Selecting the TWA filter affects the appearance of the data when it is charted within ADM, the data between available recorded data is shown as a zero.

The definition of the parameters of the calculation can be altered within ADM, the default configuration at installation matches the EH-40 standard.

Notes:

- The TWA, Average and OEL checkbox options in ADM are columns of data that are calculated when the data is displayed, based on the data previously downloaded and stored from the instrument. The values do not come from the instrument.
- Adding the TWA column causes ADM to show an additional 24 hours of “zero” readings so the user can see the TWA value decay back to 0.
- Adding any of these calculated columns makes more sense when choosing data from a single identifier (Person or Area) using the ID Filter.
- Adding any of these calculated columns is optional depending on the application but is provided for user flexibility.

Time/Date	SITEID	LOCID	Baro (mb)	Rdg Type	AvgN2O (ppm)	AvgPeriod (Mins)	TWA (ppm)	Average (ppm)	Serial No
02/06/2010 16:24:36	AREA	A	1014.00	Auto	9.00	15.00	0.28	9.00	IN00108
02/06/2010 16:39:36	AREA	A	1013.00	Auto	10.00	15.00	0.59	9.50	IN00108
02/06/2010 16:54:36	AREA	A	1012.00	Auto	10.00	15.00	0.91	9.67	IN00108
02/06/2010 17:09:36	AREA	A	1014.00	Auto	10.00	15.00	1.22	9.75	IN00108
02/06/2010 17:24:36	AREA	A	1014.00	Auto	11.00	15.00	1.56	10.00	IN00108
02/06/2010 17:39:36	AREA	A	1014.00	Auto	10.00	15.00	1.88	10.00	IN00108
02/06/2010 17:54:36	AREA	A	1014.00	Auto	10.00	15.00	2.19	10.00	IN00108
02/06/2010 18:09:36	AREA	A	1014.00	Auto	10.00	15.00	2.50	10.00	IN00108
02/06/2010 18:24:36	AREA	A	1014.00	Auto	9.00	15.00	2.78	9.89	IN00108
02/06/2010 18:39:36	AREA	A	1015.00	Auto	9.00	15.00	3.06	9.80	IN00108
02/06/2010 18:54:36	AREA	A	1013.00	Auto	9.00	15.00	3.34	9.73	IN00108
02/06/2010 19:09:36	AREA	A	1014.00	Auto	8.00	15.00	3.59	9.58	IN00108
02/06/2010 19:24:36	AREA	A	1014.00	Auto	8.00	15.00	3.84	9.46	IN00108
02/06/2010 19:39:36	AREA	A	1012.00	Auto	8.00	15.00	4.09	9.36	IN00108
02/06/2010 19:54:36	AREA	A	1014.00	Auto	8.00	15.00	4.34	9.27	IN00108
02/06/2010 20:09:36	AREA	A	1015.00	Auto	7.00	15.00	4.56	9.13	IN00108
02/06/2010 20:24:36	AREA	A	1014.00	Auto	7.00	15.00	4.78	9.00	IN00108
02/06/2010 20:39:36	AREA	A	1014.00	Auto	7.00	15.00	5.00	8.89	IN00108
02/06/2010 20:54:36	AREA	A	1014.00	Auto	6.00	15.00	5.19	8.74	IN00108
02/06/2010 21:09:36	AREA	A	1014.00	Auto	6.00	15.00	5.38	8.60	IN00108
02/06/2010 21:24:36	AREA	A	1014.00	Auto	6.00	15.00	5.56	8.48	IN00108
02/06/2010 21:39:36	AREA	A	1014.00	Auto	5.00	15.00	5.72	8.32	IN00108

Figure 3 - Example of Data recorded on the Analyser in Area mode, and then ADM calculating the TWA and Average Columns

The screenshot shows the Analyser Data Manager (ADM) software interface. At the top, there are tabs for 'Historical Data', 'Configuration', and 'About'. Below the tabs, there is a filter section with 'ID Filter' set to 'PERSON*' and 'Time Range' from '02/06/2010 16:16' to '03/06/2010 09:57'. A 'Show:' dropdown menu is open, showing 'TWA' (checked), 'Average' (checked), and 'OEL' (unchecked). Below the filter section, there are view options: 'Table' (checked), 'Graph', 'Split Horizontally', and 'Split Vertically'. The main area displays a data table with the following columns: Time/Date, SITEID, LOCID, Base (mb), Rdg Type, AvgN2O (ppm), AvgPeriod (Mins), TWA (ppm), Average (ppm), and Serial No. The table contains 20 rows of data recorded on 03/06/2010.

Time/Date	SITEID	LOCID	Base (mb)	Rdg Type	AvgN2O (ppm)	AvgPeriod (Mins)	TWA (ppm)	Average (ppm)	Serial No
03/06/2010 10:28:48	PERSON	B	1015.00	TWA	4.00	15.00	0.13	4.00	IN00108
03/06/2010 10:41:46	PERSON	B	1015.00	TWA	4.00	15.00	0.25	4.00	IN00108
03/06/2010 10:56:46	PERSON	B	1015.00	TWA	5.00	15.00	0.41	4.33	IN00108
03/06/2010 11:08:17	PERSON	B	1015.00	TWA	5.00	11.00	0.52	4.46	IN00108
03/06/2010 11:23:17	PERSON	B	1015.00	TWA	0.00	15.00	0.52	3.52	IN00108
03/06/2010 11:38:17	PERSON	B	1015.00	TWA	0.00	15.00	0.52	2.91	IN00108
03/06/2010 11:53:17	PERSON	B	1015.00	TWA	0.00	15.00	0.52	2.48	IN00108
03/06/2010 12:08:17	PERSON	B	1015.00	TWA	0.00	15.00	0.52	2.16	IN00108
03/06/2010 12:23:17	PERSON	B	1015.00	TWA	0.00	15.00	0.52	1.91	IN00108
03/06/2010 12:38:17	PERSON	B	1015.00	TWA	0.00	15.00	0.52	1.71	IN00108
03/06/2010 12:53:17	PERSON	B	1015.00	TWA	0.00	15.00	0.52	1.55	IN00108
03/06/2010 13:08:17	PERSON	B	1015.00	TWA	0.00	15.00	0.52	1.42	IN00108
03/06/2010 13:23:17	PERSON	B	1015.00	TWA	0.00	15.00	0.52	1.31	IN00108
03/06/2010 13:38:17	PERSON	B	1015.00	TWA	0.00	15.00	0.52	1.21	IN00108
03/06/2010 13:53:17	PERSON	B	1015.00	TWA	0.00	15.00	0.52	1.13	IN00108
03/06/2010 14:08:17	PERSON	B	1015.00	TWA	0.00	15.00	0.52	1.06	IN00108
03/06/2010 14:23:17	PERSON	B	1015.00	TWA	0.00	15.00	0.52	1.00	IN00108

Figure 4 - Example of Data recorded on the Analyser in Person mode, and then ADM calculating the TWA and Average Columns

TAKING READINGS

Preliminary Checks - Best Practice

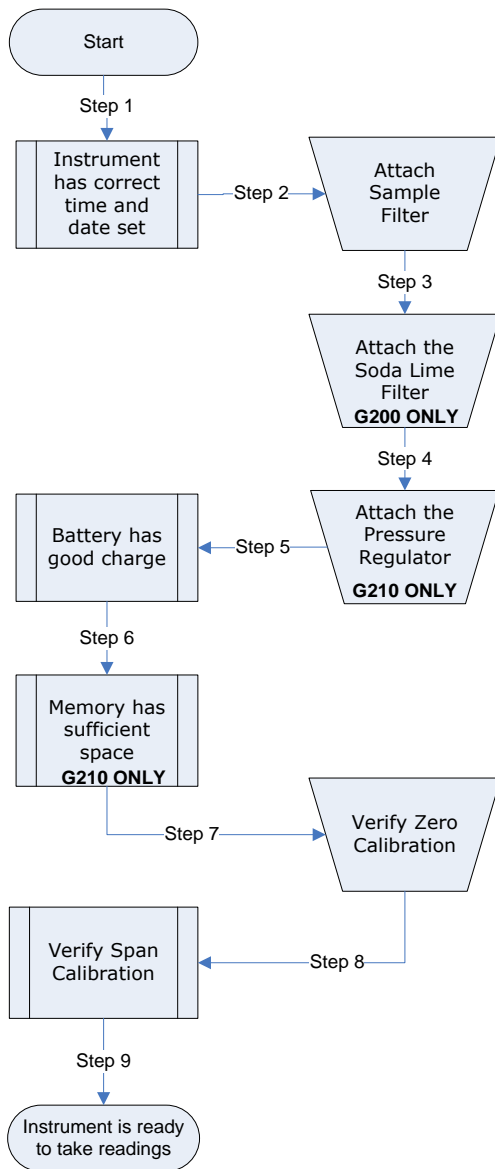

Preliminary Checks (G200 Range - Best Practice)

Prior to use, it is good practice to ensure that:

- Step 1** The instrument has the correct time and date set.
- Step 2** Check that the sample filter is fitted and that it is clean and dry.
- Step 3** Attach the soda lime CO₂ filter (G200 model only).
- Step 4** Attach the pressure regulator (G210 model only).
- Step 5** The battery has a good charge (minimum 25% charge, even if only a few readings are required).
- Step 6** The memory has sufficient space available (G210 model only).
- Step 7** Verify that the main gases have been auto-zeroed, without gas concentration present.

Note: The unit should be left to reach thermal equilibrium before zeroing, see note in [Zero Calibration](#).

- Step 8** Verify the span calibration with a known concentration calibration-check gas.

- Step 9** Instrument is ready to take readings.

Do protect the instrument from strong direct sunlight which will quickly raise the temperature of the instrument beyond its operating range and the LCD display will appear almost black. The contrast setting cannot then alter the contrast.

Do remember to always use the sample filter! If the sample filter becomes contaminated, change it and ensure all sample tubes are clean and dry before re-use.

Do not place the instrument against anything hot as this may cause excessive internal temperatures, which can lead to erroneous readings.



Always ensure that the exhaust gases emerge in a safe manner into a well-ventilated area.

G200 Gas Measurement Process – Best Practice

Depending on preferences the exact reading procedure can change. The following methods are considered best practice and when followed correctly will allow quick and consistent readings to be recorded.

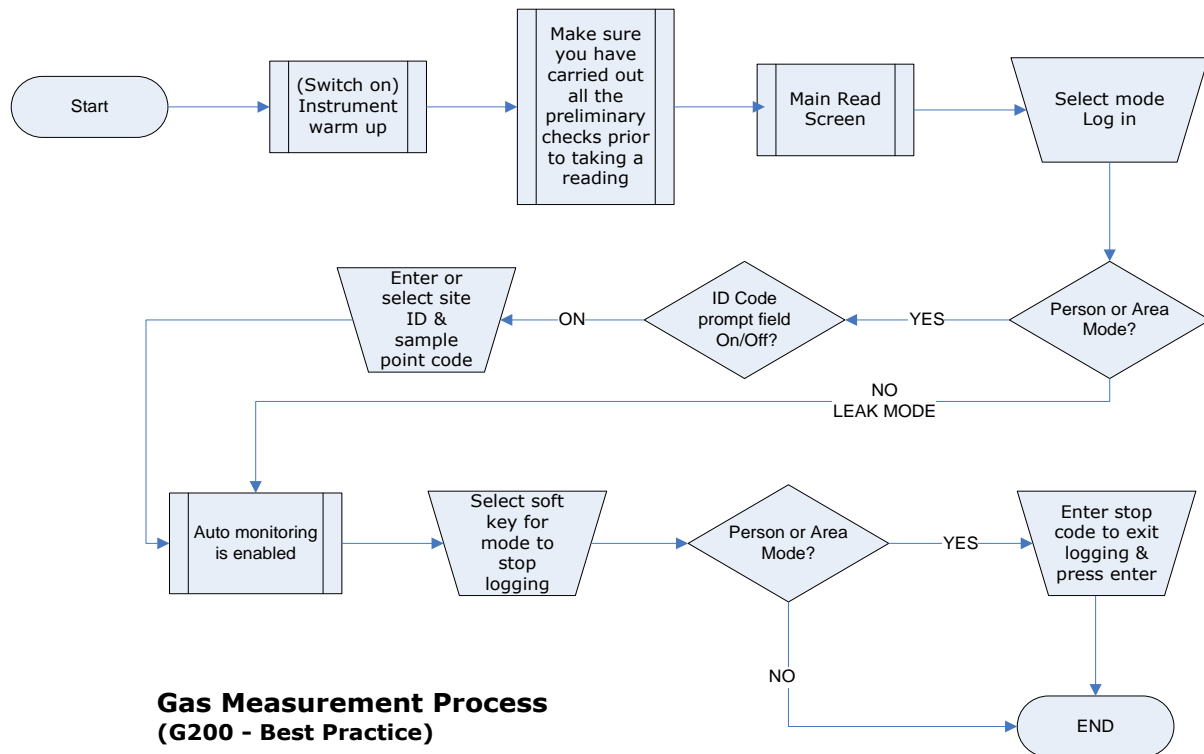

- 1) When the instrument is first switched on it should be purged with fresh air and allowed to stabilise for a few minutes.
- 2) Make sure that you have carried out all the preliminary checks as listed in section '6.1 Preliminary Checks – Best Practice' and that the instrument is ready to take the first reading. Always use a sample filter and a soda lime filter with a G200 instrument.
- 3) Connect the sample tube, if relevant, from the sample point to the inlet port of the instrument, ensuring the filter is seated correctly.
- 4) From the 'Main' menu select the mode in which you wish to operate the instrument.

Note: Although the G200 analyser is intended for use in a specific mode, i.e. Person, Area or Leak, the analyser may be used to take readings without a mode specified. For more information please refer to section [G210 Gas Measurement Process – Best Practice](#).

- 5) If 'Person' or 'Area' mode is specified the operator will be prompted to enter a 'Site' and 'ID' to identify the reading. If the operator chooses to monitor readings in 'Leak' mode then no ID is required.

Operating Manual

- 6) If operating in 'Person' or 'Area' mode readings are continuously taken by the instrument. To stop monitoring the operator must select the appropriate 'soft-key' and enter the required stop code.
- 7) If operating in 'Leak' mode the operator may start and stop monitoring by selecting the appropriate soft-key.

G210 Gas Measurement Process – Best Practice

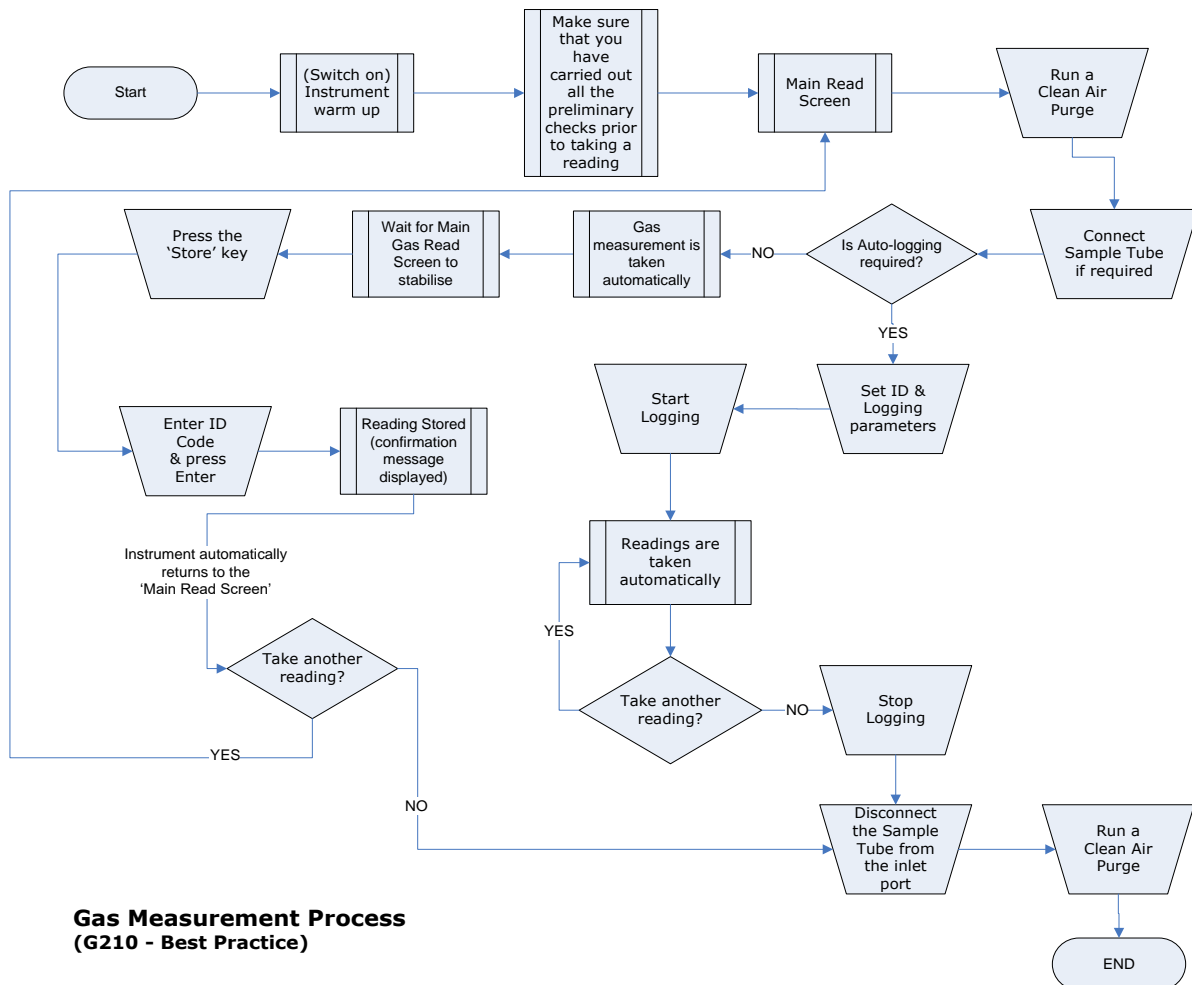

- 1) When the instrument is first switched on it should be purged with fresh air and allowed to stabilise for a few minutes.
- 2) Make sure that you have carried out all the preliminary checks as listed in section '6.1 Preliminary Checks – Best Practice' and that the instrument is ready to take the first reading. Always use a regulator pressure kit with the G210 instrument.

Note: Alternative methods of pressure reduction are available and could be used. However, to avoid irreversible damage to the instrument, please seek guidance from the supplier/manufacturer before using any other pressure device.

Operating Manual

- 3) Connect the sample tube, if relevant, from the sample point to the inlet port of the instrument, ensuring the filter is seated correctly.
- 4) If auto-logging is required select the ID codes.
- 5) If auto-logging is not required, press the pump key to draw a sample, stop the pump and press the soft-key 'Store' to store the reading. The operator will then be prompted to enter or select ID codes. Select ID codes and press the 'Accept' button to confirm. A message will display confirming that the reading has been stored.
- 6) The instrument automatically takes the operator back to the 'Main Read Screen' ready to take another reading.

CALIBRATION

User Calibration

The G200 range of instruments is fully calibrated during manufacture and when returned for service. However, to improve accuracy between services a user/field calibration can be performed.

This section sets out the correct procedures to achieve an accurate user calibration.

Note: If the calibration is completed incorrectly it may decrease the accuracy of the instrument.

Two important terms that are used within this section are “Zero” and “Span”.

Zero: The point at which the instrument is calibrated when there is none of the target gas present.

Span: The point at which the instrument is calibrated when a known quantity of the target gas is present.

Calibration Gases

User calibration of the instrument will improve the data accuracy in the range of the calibration gases used. However, it may cause less accurate readings of concentrations outside this calibrated range. Users should select the correct calibration gas for the expected gas levels on their particular application. Only use gases with a known certified gas concentration.

Note: Certified calibration gases can be supplied by QED.



For each gas used the appropriate material safety data sheet must be read and understood before proceeding. Calibration gases and the use of pressure regulators can be dangerous.

Calibration Set-up

The regulator supplied with the calibration kit has been configured to deliver a fixed flow. It only requires a few turns to open and no adjustment is necessary.

Exhaust Port

When the instrument is being calibrated, there are two possible exits for the gas; via the usual manner out of the exhaust port of the instrument or in cases of over-pressurisation the 1/16” port on the pressure relief valve.



It is recommended that both ports have exhaust tubing attached. The exhaust tubing must emerge in a well-vented area. Ensure there are no leaks in the tubing and connections.

The calibration should always be carried out in a safe area with all necessary precautions taken as all pressurised gases are potentially dangerous.

Calibration Equipment

The diagram below displays the regulator and tubing equipment for user calibration:

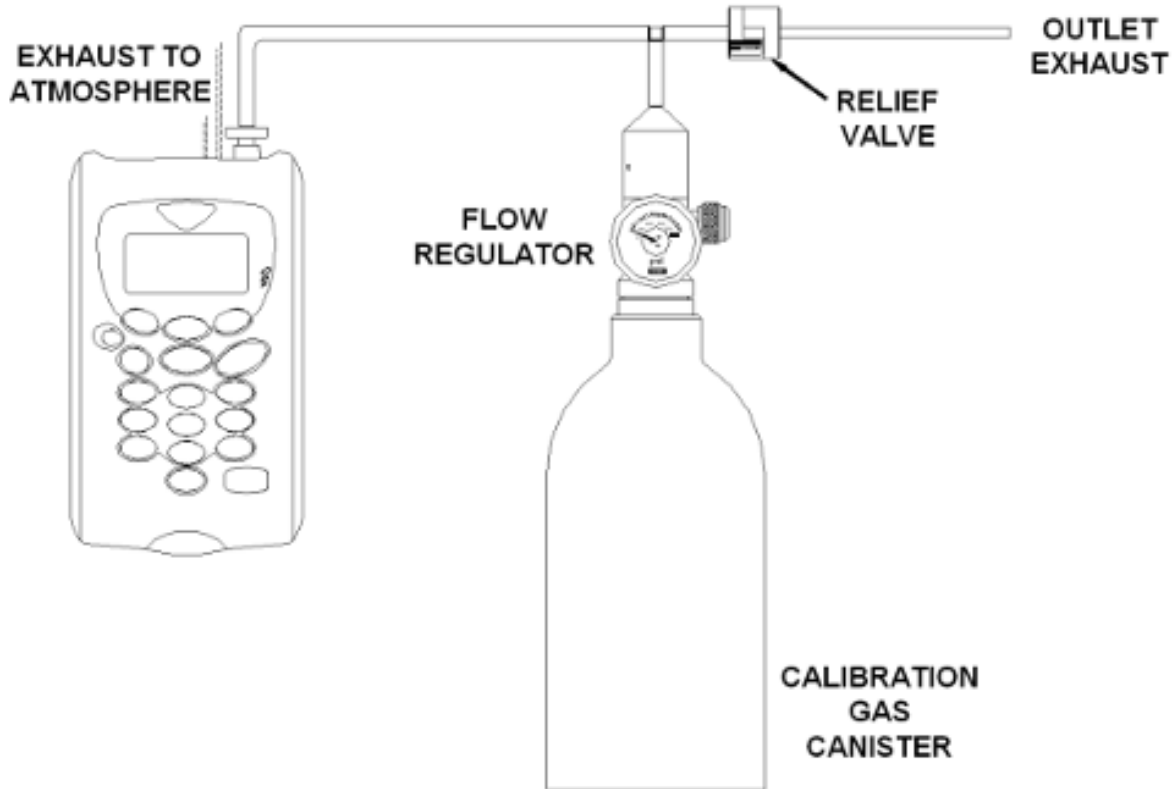

- Certified calibration gas in 58 litre gas canisters is supplied with the QED calibration kit. Please refer to the QED website www.qedenv.co.uk for further information.
- The regulator supplied with the calibration kit is recommended as flow and pressure rates are factory set.

Note: Maximum input pressure 250mb maximum flow 300ml.

Calibration Method

Before you begin ensure the unit is turned on and allowed to stabilise at its working temperature before performing any of the calibration options, this will typically be 15-20 minutes.

To achieve the processes set out in this section, press 'Key 3 – Calibration' from the 'Main' menu. The first screen displayed provides the option to select the gas that requires calibration.

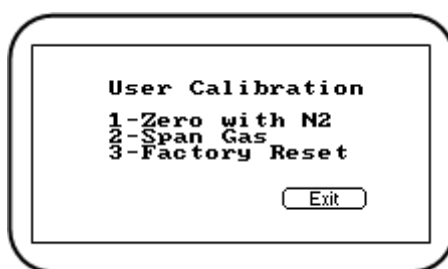

Screen 19 - Calibration menu

The exact calibration method can vary depending on the gases used.

Zero Calibration

For maximum accuracy it is recommended that the measurement channel is zeroed using bottled gas (certified 100% N₂). Due to the CO₂ cross-gas effect on N₂O, if nitrogen gas is not available the optional soda lime CO₂ filter kit can be fitted to the gas inlet. This allows the user to perform a zero using normal air as the soda lime CO₂ filter will absorb virtually all CO₂ from the sample air. For both these options select 'Key 1-Zero with N₂' from the user calibration menu.

Note: In normal use, it is recommended that the soda lime CO₂ filter kit is always used. This kit is not required for normal use of the G210, as it measures CO₂ as standard. For further information about cross-gas effects, refer to section [Cross-Gas Effects](#) of this manual.

Note: For all three of the aforementioned methods of zeroing and Air calibrating the instrument, it is preferred that the instrument is left in its 'on state' to reach thermal equilibrium before completing this process (approximately 40 minutes). However, the instrument can be zeroed or Air calibrated immediately after turning it on and then subsequently used to measure but this process must be repeated after the 40 minute thermal equilibrium time.

- 1) From the calibration menu, Select 'Key 1 - Zero with N₂' (recommended) and either attach the 100% N₂ or soda lime CO₂ filter kit.
- 2) Press the 'Start' key. The instrument will now wait (a minimum of 60 seconds) for the gas reading to stabilise at the correct level. If zeroing with the soda lime kit in fresh air press the 'Pump' key to draw in fresh air. This operation will time out after one hour if readings cannot be stabilised.
- 3) The instrument will then indicate a successful zero has been completed. Press the soft-key 'Accept' to confirm the calibration and store the new user offset. Alternatively, soft-key 'Reject' to exit without change.

Operating Manual

Note: If the calibration failed then purge and try again or select a different air source.

Note: If using G210 – very high concentrations of CO₂ may take up to 30 minutes to purge completely. O₂ is not zeroed.

Span Channels

It is recommended that the instrument is spanned to target the desired reading range (refer to section [Recommended Gases for Calibration](#) of this manual for more information); ideally this should not be a low level close to zero.

- 1) If not already preset, enter the correct **span target**, i.e. certified concentration of your calibration gas. Press 'Key 1' and enter the new value. Then attach the gas and open regulator valve to allow the gas to flow.
- 2) Press the 'Start' key and wait for the reading to stabilise. This can take a couple of minutes.
- 3) Once a stable reading is shown press the soft-key 'Accept'. A successful span calibration message will then be displayed. Press the soft-key 'Accept' again to confirm the calibration and 'Store' the new user span. Alternatively, press soft-key 'Reject' to exit without change.

Note: If the calibration failed then try again using a longer purge time or different target gas.

Last Field Calibration

This data can be found in the 'Information' screen accessed via the 'Utilities' menu. This option displays the date that the last field calibration was performed on the instrument.

Calibration Record

The G200 instruments have the facility to log user calibrations via the 'Event Log'. This can be used as an aid in ensuring that gas measurements are valid and accurate.

During calibration the instrument will record the following in the event log. For each entry the time and date will be stored.

Event	Data Recorded
Successful user zero for selected gas	Type (N ₂ or Air) and Readings before and after
Successful user span for selected gas	Target Value, Readings before and after
Successful user span for selected gas	Target Value, Readings before and after
Failed user zero for selected gas	Type (N ₂ or Air) and Reading
Failed user span for selected gas	Target Value, Gas Reading
Failed user span for selected gas	Target Value, Gas Reading
Return to factory settings	

Note: If the calibration failed, then try again using a longer purge time or different target gas. This event log can only be downloaded and viewed via the optional Analyser Data Manager software. It cannot be viewed on the analyser screen.

Operating Manual

Recommended Gases for Calibration

The calibration gas recommended depends on the desired operation and concentration of target gas. The following table outlines the recommended gases that can be used for calibrating each of the measurements.

Instrument	G200		G210	
Application	OEL	Leak	N ₂ O 50%, O ₂ 50%	O ₂ 100%, N ₂ O
Zero Calibration Gases				
N ₂ 100%	N ₂ O	N ₂ O	O ₂ , N ₂ O, CO, CO ₂	O ₂ , N ₂ O, CO, CO ₂
Span Calibration Gases				
N ₂ O 100ppm	N ₂ O			
N ₂ O 500ppm		N ₂ O		
O ₂ 100%				O ₂
N ₂ O 50%, O ₂ 50%			N ₂ O, O ₂	
N ₂ O 100%				N ₂ O
CO 100ppm, CO ₂ 500ppm			CO, CO ₂	CO, CO ₂

G200 Range Calibration – Best Practice

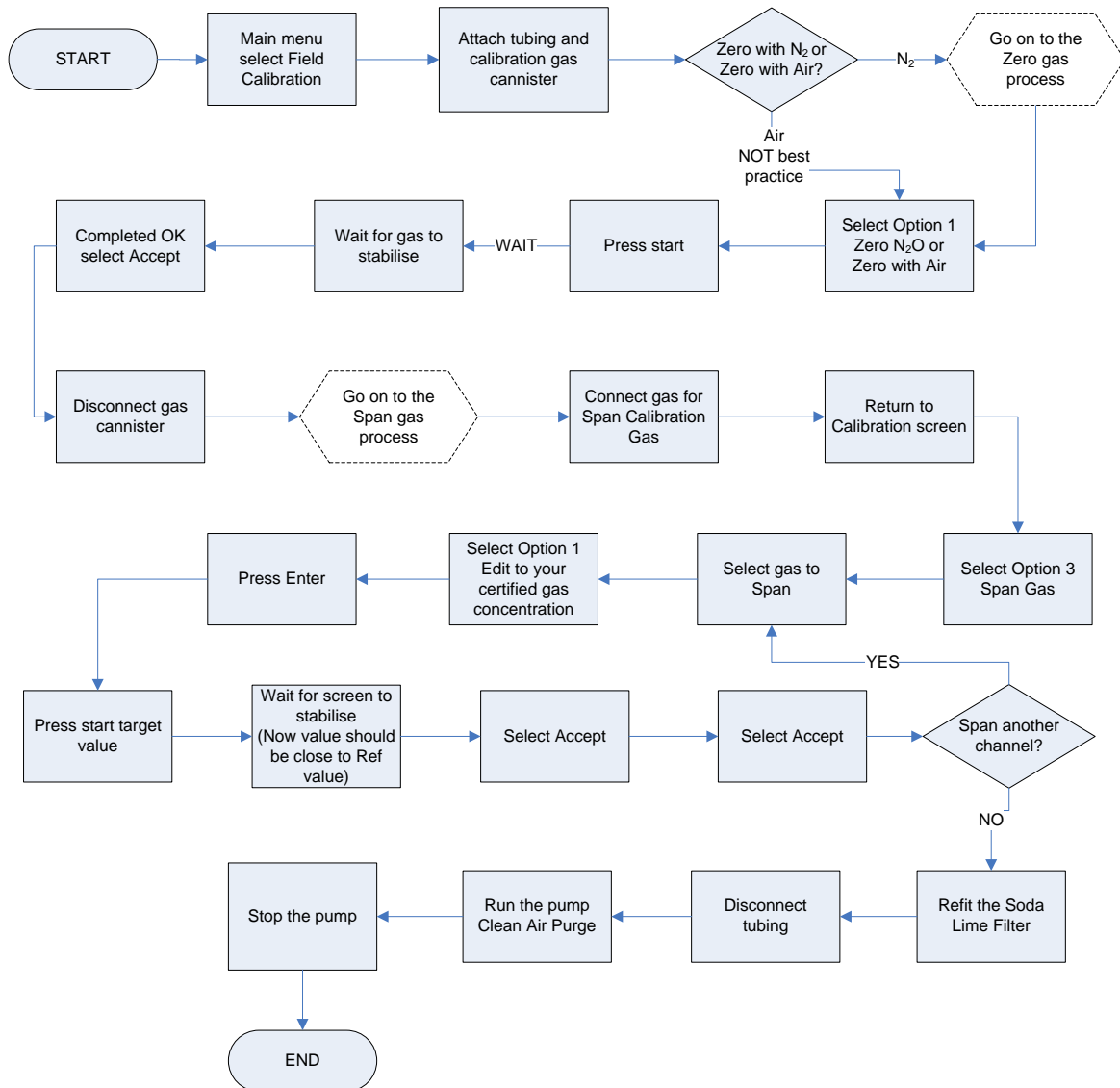

PROBLEM SOLVING

This section outlines various warning and error messages which the operator may receive during general operation of the instrument. For further assistance please contact Technical Support at QED on +44(0)330 800 0088 or email technical@qedenv.co.uk.

Warnings and Errors

When switched on the instrument will perform a predetermined self-test sequence taking approximately 15 seconds. During this time many of the instrument's working parameters and settings are checked.

If any operational parameters are out of specification or if the pre-programmed recommended calibration/service date has passed, errors or warnings may be displayed.

Use the 'Scroll Up' and 'Scroll Down' keys to move through the list if required.

There are two types of warning that may be displayed:

- General warnings that may not affect the instrument's function and those where the self-test has detected a function that is outside the usual operating criteria, e.g. battery charge low, memory nearly full.
- Operational parameters that could affect the performance of the instrument, e.g. N₂O out of calibration.

The most likely reason for these errors is either an incorrect user calibration or they may indicate sensor failure. If an incorrect user calibration has caused the warning it should be correctable by way of returning the instrument to factory settings, zeroing or carrying out a user calibration as necessary for the relevant function.

Under and Over Range Codes

If a reading is over range (i.e. above the maximum allowed reading) it will be displayed with more than chevrons (>>.>). This can occur if a channel has been incorrectly calibrated or the sample gas has exceeded its specified range (e.g. N₂O > 20%).

If a reading is under range (i.e. below zero) it will be displayed with less than chevrons (<<.<). Refer to section [Calibration](#) of this manual to remedy under-range by performing a user zero.

A number displayed as asterisks (**.*) indicates an error, usually where the instrument has been unable to complete a particular calculation. Typically, this will be the first indication of a fault condition.

Where no data is available dashes (--.-) are displayed. This usually occurs when a particular reading or parameter has been skipped by the user, or where an optional accessory is not fitted correctly, i.e. a temperature probe.

Operating Manual

Self-test Warning Messages

The following warnings may be displayed during the self-test period when the instrument is switched ON.

Warning		Description
Check Memory		The instrument only has space to store less than 50 readings before it is full. The exact number can be checked using the 'View Readings' option.
Memory Full		There is no more space in memory to store readings. Both the store and log options will be disabled until the memory is cleared. The readings should be downloaded to PC using the optional download software before memory is cleared.
Battery Low	⏻	The instrument does not have enough power to operate for a full day. The instrument should be recharged or connected to an external power supply.
Service Due	🔧	It has been 12 months (or more) since the instrument was returned to the manufacturer for a service. The performance and accuracy of the instrument may be impaired.
Low Flow		The instrument's gas inlet (or outlet) may be blocked. This warning is most commonly caused by a water-logged or dirty sample filter. Change the sample filter and check for obvious blockages in the sample tubes. Alternatively, a small amount of adjustment can be made to the low flow detection point to compensate for minor changes in the performance of the pump fitted to the instrument.
Check N ₂ O Cal.		This warning is most commonly caused by an incorrect user calibration. Try recalibrating the sensor or press 'Return to factory settings'. If the warning persists it may be caused by dirt or damage to the infrared sensor. The instrument will need to be returned to the manufacturer for service/repair.
Check O ₂ Cal.		This warning is most commonly caused by an incorrect user calibration. Try recalibrating the sensor or press 'Return to factory settings'. If the warning persists it may be caused by a damaged or faulty sensor. The instrument will need to be returned to the manufacturer for service/repair.
Ref. Fault		This may be caused by dirt or damage to the infrared sensor in the instrument. The instrument will need to be returned to the manufacturer for service/repair.
*Invalid Config.		The instrument has detected a problem with the configuration parameters most likely caused after a firmware update. The instrument will need to be returned to the manufacturer for service/repair.
Change O ₂ Cell	🔧	The oxygen cell has not been changed for at least 3 years; its performance and accuracy may be impaired. The instrument will need to be returned to the manufacturer for service.
Change CO Cell	🔧	The carbon monoxide cell has not been changed for at least 2 years; its performance and accuracy may be impaired. The instrument will need to be returned to the manufacturer for service.

Change Pump	Y	The pump has exceeded its recommended run-time and should be changed. The instrument will need to be returned to the manufacturer for service.
Change Battery	Y	The Lithium Ion battery has exceeded its recommended life-time or number of charge cycles and should be changed. The instrument will need to be returned to the manufacturer for service.
User Cal. Due		It has been over a month since the instrument was last user calibrated. For optimal performance and accuracy it is recommended that the instrument is user calibrated each time it is used.
Invalid Time		The instrument has an invalid time. This is most likely to occur after a reset. The correct time should be entered using the set 'Time & Date' option via the 'Utilities' menu.
Invalid Date		The instrument has an invalid date. This is most likely to occur after a reset. The correct date should be entered using the set 'Time & Date' option via the 'Utilities' menu.
Baro. Fault		The instrument has detected a fault with the barometric sensor or its calibration. This will have an effect on the accuracy of the readings as they are pressure compensated. The instrument will need to be returned to the manufacturer for service.
**Sensor n Failed		Sensor n is expected but not reading a valid value. This is generally a hardware fault or the instrument has been configured incorrectly. Please contact the manufacturer.
** Sensor n Range		Sensor n raw value is outside expected range. This is generally a hardware fault or the instrument has been configured incorrectly. Please contact the manufacturer.
**Sensor n Stability		Sensor n has not reached a stable value within the warm-up time limit. The instrument may have been left with gas in. Please purge and retry. If the instrument shows a stable reading on the main screen this warning can be ignored.

Note:

*Certain configuration problems can be corrected remotely.

** Where n equals the sensor channel number.

Note: Using the Analyser Data Manager software, it is possible to export the current configuration and e-mail it to the manufacturer's Technical Support or Service Department. Depending on the type of error, it may be possible to correct the configuration file and import it back into the instrument. For further information please contact QED Technical Support on +44(0)330 800 0088.

User Calibration Trouble Shooting	
Error	Remedy
User Zero failed	A possible reason for this is that the instrument is trying to zero to a level which is outside the predetermined range set when the unit was calibrated at the factory. To rectify this, first ensure the unit contains absolutely none of the gas which is being zeroed by flushing thoroughly with nitrogen. If it will not zero, then refer to the instructions given in the 'Factory Settings' section. If the instrument continues to fail to zero then the unit must be returned to the manufacturer for investigation.
Calibration failed	Check the span target is set to the correct value, if not, correct and retry spanning the channel. Repeat the entire procedure, including zeroing the channel and then calibrate the span. Ensure the reading is stable before spanning the channel.

User Calibration Explained:

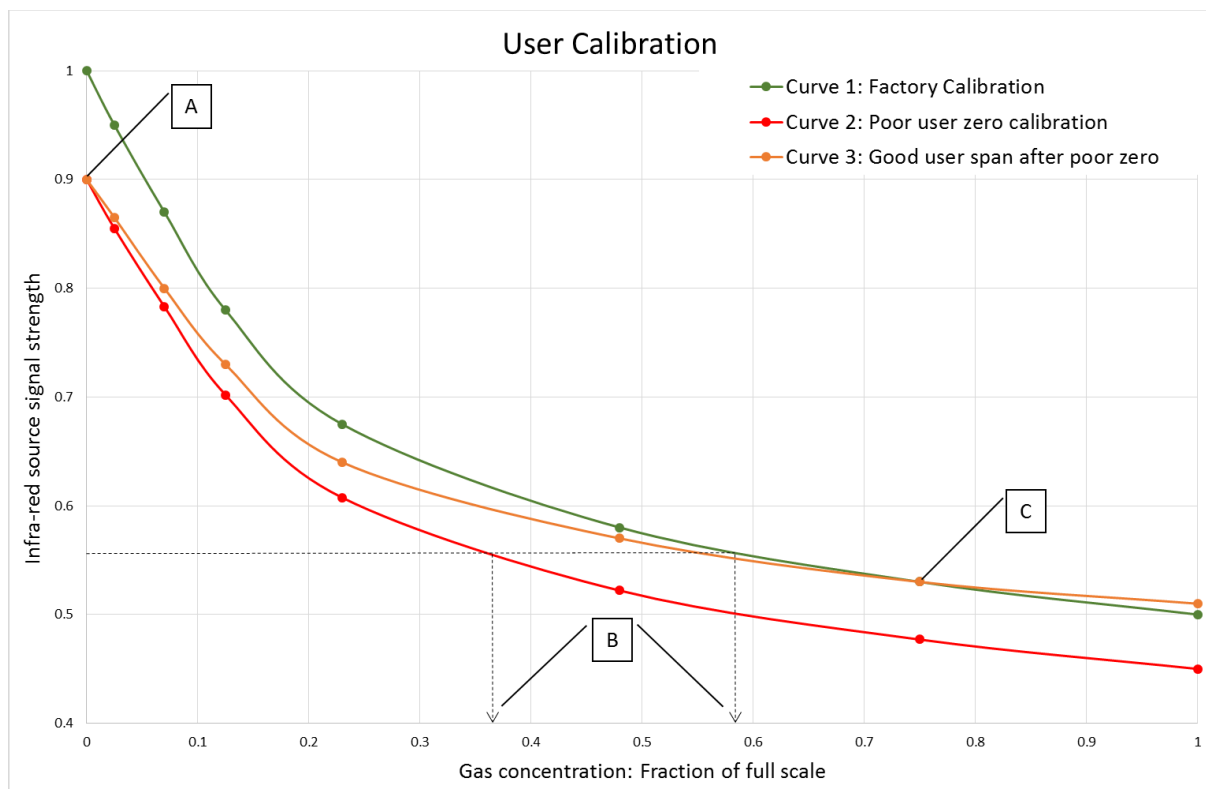

Graph 1 - User calibration explained

User calibration is a means of optimising the performance of the instrument to the current operating conditions such as ambient temperature and pressure as well as correcting for instrument drift caused by lamp and filter settling.

In general, the instrument should not require calibration more than once a month, but we do recommend verifying the instruments operation each day.

Operating Manual

User calibration has two operations and each may be performed individually, however for a complete user calibration both must be completed.

Factory Calibration

When the instrument is factory calibrated, a stable gas curve is generated (see curve 1 on [Graph 1 - User calibration explained](#)). This curve is then used to determine the gas concentration based on the infrared signal strength after being absorbed by the gas.

Zero Calibration

A zero calibration is used to correct the entire curve for the infrared source and filter variations caused by aging and induced drift due to dirt and other contaminants. If done correctly, there is often no need to complete a span calibration, as the new curve will follow closely to the factory calibration curve (curve 1 on [Graph 1 - User calibration explained](#)).

The zero calibration is very sensitive and a rushed or poor calibration, (such as the target gas still being present), will result in a zero error; see point A on curve 2 of [Graph 1 - User calibration explained](#). This also produces an error throughout the remainder of the curve proportional to signal strength, but the effect on the span is significant, see point B on [Graph 1 - User calibration explained](#).

Note: To perform an accurate user calibration it is critical that a good user zero has been performed. QED recommend that this be done in nitrogen in order to guarantee that none of the gas of interest is present.

Note: The Zero calibration is very sensitive and even 100% instruments will detect in the 0 to 100ppm range even though they do not display to this resolution. Please refer to [Graph 2 - Typical zero gas purge times](#).

Span Calibration

A span calibration is used to optimise the analyser at the span calibration concentration (see point C on [Graph 1 - User calibration explained](#)) for the current operational conditions. It corrects the span point but leaves the zero unadjusted (this will be left at the last user zero if this has been performed) and should be done at the concentration of interest in the particular application.

If the user zero is poor and the span calibration is good, it will correct the gas curve for the point of interest, but other points on the curve could be incorrect, see curve 3 on [Graph 1 - User calibration explained](#).

Typical Calibration Purge Times

Typical zero calibration although displaying zero needs to be given time to settle. We recommend commencing the calibration at least five minutes after the display concentration stabilises.

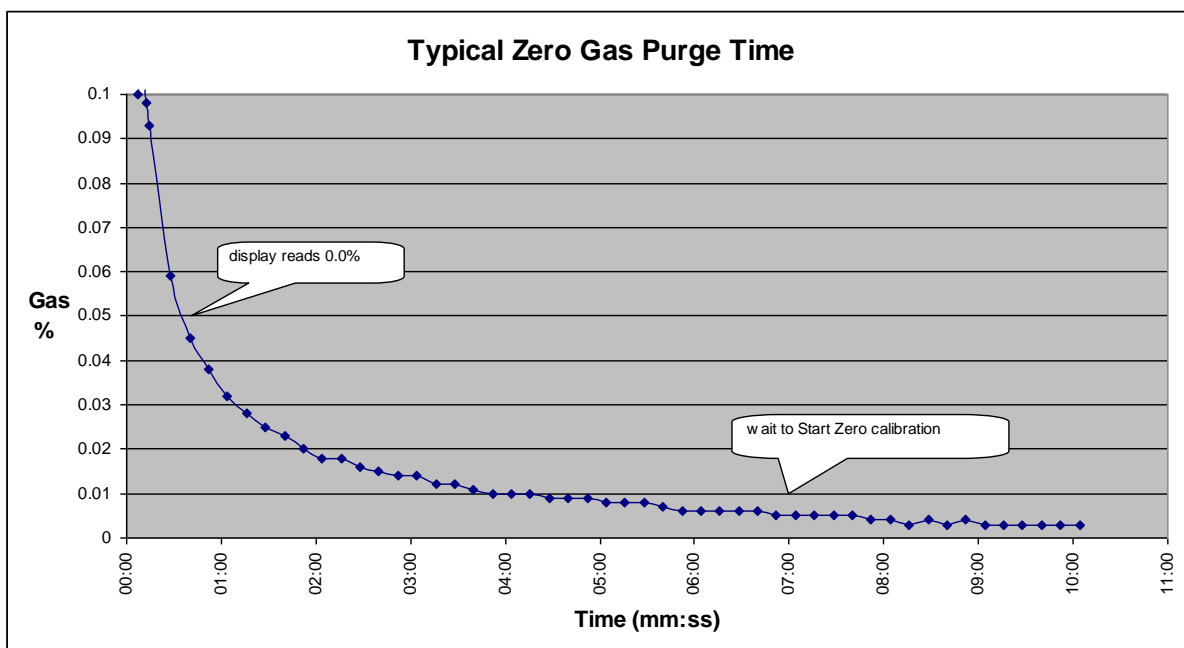

Graph 2 - Typical zero gas purge times

Cross-Gas Effects

CO₂ Cell

Carbon dioxide is measured by infrared absorption at a wavelength specific to carbon dioxide. There is a small cross interference of 1,000:1 from N₂O which is compensated for within the G210. Therefore, the carbon dioxide reading will not be affected by any other gases.

O₂ Cell

The oxygen sensor is a galvanic cell type and suffers virtually no influence from CO₂, CO, H₂S, NO₂, SO₂ or H₂, unlike many other types of oxygen cell.

N₂O Cell

Nitrous oxide is measured by infrared absorption at a wavelength specific to nitrous oxide and suffers virtually no influence from CO, H₂S, NO₂, SO₂ or H₂.

Note: To compensate for the influence of N₂O on the CO₂ it is important the Zero and N₂O Span calibrations do not contain CO₂. CO₂ will have an influence on the N₂O channel. It is recommended that the Soda Lime CO₂ filter is used.

CO Cell

Carbon monoxide is measured by an electrochemical gas sensor. It is not affected by the other measurement gases but can have cross interference from gases not normally present in medical supply gases and suffers virtually no influence from CO₂, H₂S, NO₂, SO₂.

Hardware Reset

If for any reason the instrument 'locks up' and will not switch off, or the instrument appears off and will not turn on, it is possible to force an emergency power off. Pressing and holding the 'On/Off' key

Operating Manual

for 10 seconds will power off the instrument. Once this time has elapsed, the instrument can be powered on as normal.

Note: Performing a hardware reset may cause loss or corruption of currently stored data including the time/date.

SERVICE

The G200 and G210 instruments should be regularly serviced to ensure correct operation and accurate readings. The manufacturer recommends a full service and recalibration **every 12 months**.

Depending on usage the O₂ cell should be replaced every 2-3 years. The CO cell will require replacement after 1 or 2 years again depending on usage.

User Serviceable Parts

Note: There are no user serviceable parts inside the instrument. Please do not attempt any repair as this may invalidate any warranty supplied with your instrument.

The following parts are supplied by your instrument manufacturer and can be replaced by the user:

Sample Filter	This should be regularly inspected for damage or discolouration and changed if needed. The instrument should never be operated without the sample filter as this may result in water or dust entering the instrument. The filter should be changed immediately if water can be seen. Failure to do so can damage the instrument.
Sample Tubing	Always ensure that sample tubes are not contaminated or damaged.
Soda Lime CO ₂ Filter	This should be regularly inspected for damage or discolouration and changed if needed. The G200 instrument should never be operated without the soda lime CO ₂ filter as any CO ₂ will cross-contaminate the N ₂ O reading.

Cleaning

The instrument and accessories (including power supply unit) can be wiped clean using a non-fibrous damp cloth.

Note: Do NOT apply pressure to the LCD display as this can cause damage.

Note: Do NOT use solvents or any other chemical cleaners.

WARRANTY POLICY



G100 Range and G200 Range Warranty Terms and Conditions

QED will repair or replace (at QED's discretion) any goods supplied by the company in respect to defects arising within **12 months** from date of purchase or delivery, whichever is later, provided that:

- The model is a G100, G110, G150, G200, or G210 gas analyser.
- The defect is due to faulty parts or workmanship provided by QED.
- Proof of delivery/purchase must be provided to QED for any claims. This includes a QED sales order, invoice, or delivery note.
- All warranty repairs can only be carried out by QED or its authorised agents. In certain circumstances, permission may be granted by QED for the owner to replace a supplied part under warranty.
- Any repair or replacement component under warranty will not extend the warranty period of the analyser.
- Products must have been returned for service and calibration as recommended by QED as per the individual operating manual.
- Where replacement parts have been supplied by QED under warranty, the replaced parts must be returned to QED. If not returned, QED reserve the right to charge for the replacement part.
- If no fault is found an investigation charge may apply.
- QED's Technical Support **MUST** be notified in the event of a pending warranty claim. They will then issue a returns reference number that must be included in any return. Failure to provide this will void any warranty claim.

The following is not included:

- Normal wear and tear of parts that might wear out over time, or be consumed, is not covered. Parts not covered include, but not limited to the PTFE filter, oxygen sensor, and tubing.
- A service is not part of a warranty claim.
- Accidental damage, including dropping during use.
- Damage as a result of vandalism.
- Faults arising from use of the equipment that is not in accordance with standard operating procedures laid out in QED's operating manual.
- Faults arising from use of the equipment in unsuitable applications.
- Repairs or alterations carried out by parties other than QED, its authorised agents, or under the instruction of QED.
- Any data stored on the equipment that may be lost.
- A claim due to a failure in maintaining the analyser in accordance with the operating manual.
- A claim as a result of poor quality or inadequate repairs.
- Any business related losses such as income, profits, and contracts (as far as the law allows).

www.qedenv.com

GSERIESWARRANTY Iss.01
© QED Environmental Systems Ltd.



The following voids the warranty:

- When non-approved QED parts have been used for repair or maintenance.
- When parts are added, or alterations made, to the analyser outside the scope of the operating manual.
- The analyser has been opened, unless by QED approved service centres (where applicable).
- The equipment has been stored or installed outside of the operating range and environmental conditions determined in the operating manual.
- The equipment has not been maintained in accordance with the operating manual.

Service Warranty:

- QED offer a three-month warranty period, following a QED service, to cover any defects that have arisen because of that service.



Note

Warranty repair is only granted after an investigation by QED.

For assistance in determining if your equipment qualifies for warranty investigation, please contact your local distributor, or our technical support team at QED on +44(0)333 800 0088 or email technical@qedenv.co.uk.

For extended warranty options, please contact your local distributor, or our sales team at QED on +44(0)333 800 0088 or email sales@qedenv.co.uk.

For any other queries please contact your local distributor, or our sales team at QED on +44(0)333 800 0088 or email sales@qedenv.co.uk.

QED Environmental Systems reserve the right to update these terms and conditions without notice.

EVENT LOG

The following events are recorded in the instrument's event log. The event log can only be downloaded using the additional Analyser Data Manager software. Please refer to the Analyser Data Manager operating manual for further details.

Event	Data
Cold Start/Reset	Type of start (MCUSR, boot_key)
Firmware version	Description
Set time	Before and After
Set date	Before and After
Re-flash requested	None
Restore to factory settings	Type
Comms clear memory	Type 0=Readings, 1=Event Log
Change contrast	Before and After
Change flow fail current limit	Before and After
RTC date/time invalid	None
Factory calibration invalid or overdue	Date, Difference
Service invalid or overdue	Date, Difference
Field/User Calibration invalid or overdue	Time, Channel, Date, Age, Limit
O2 Cell replacement overdue	Time, Channel, Date, Age, Limit
Pump replacement overdue	Used, Limit
Battery replacement overdue	Used, Limit
EEProm settings set to default	Which
Missing EEPROM settings initialised	Which, Orig Version, New Version
CO cell replacement overdue	Time, Channel, Date, Age, Limit
Power on self-test, sensor not found	Channel
Power in self-test, sensor out of range	Channel, Reading, Low, High
Power on self-test, sensor out of range	Channel, Reading, Prev
Battery dropped below critical value	Limit, Actual
User calibration set zero OK	Before and After
User calibration set span OK	Before, After
User calibration set zero failed	Target, Reading
User calibration set span failed	Target, Reading
Attempt to store when readings memory full	Max
Readings memory nearly full	Limit, Actual
Flow fail current limit exceeded	Limit, Actual
Automatic power off	
Change logging mode	Status, Interval, Pump time
Change logging mode ID	ID
Changing logging mode ID site	Site ID
Flow fail current limit exceeded	Limit, Actual
An alarm has changed state	Alarm, State, Actual, High, Low
Change of alarm setting	Alarm, State, High, Low
Mode of instrument changed	Before, After

WEEE COMPLIANCE



WEEE COMPLIANT

The wheelie bin symbol now displayed on equipment supplied by QED signifies that the apparatus must not be disposed of through the normal municipal waste stream but through a registered recycling scheme.

The Waste Electrical and Electronic Equipment directive (WEEE) makes producers responsible from July 1st 2007 in meeting their obligations, with the fundamental aim of reducing the environmental impact of electrical and electronic equipment at the end of its life.

QED is now registered with the Environmental Agency as a producer and has joined a recycling scheme provider who will manage and report on our electrical waste on our behalf.

Our Producer Registration Number is WEE/GB0052TQ

So when your instrument is at the end of its life, please contact the Sales team at QED who will advise you on the next step in order to help us meet our obligations.

EU DECLARATION OF CONFORMITY



EU Declaration of Conformity

This Declaration of Conformity is issued under the sole responsibility of the manufacturer:

QED Environmental Systems
Cyan Park – Unit 3
Jimmy Hill Way
Coventry
CV2 4QP
UNITED KINGDOM

Product: G200, G210

Type of equipment:

- G200 – portable N2O monitor for background or personal analysis
- G210 – portable N2O monitor for accurate assessment of N2O, CO2, CO and O2



The G200 and G210 described above are in conformity with the relevant Union harmonisation legislation:

2014/30/EU: Electromagnetic capability (EMC)

- EN 50270:2006

2014/35/EU: Electrical equipment designed for use within certain voltage limits (LVD)

- EN 61010-1:2010

2011/65/EU: Restriction of the use of hazardous substances in electrical and electronic equipment (RoHS)

Signed for and on behalf of:

Name: Mr. Craig Millar
Position: Engineering Manager
Done at: QED Environmental Systems
On: 28th August 2018

www.qedenv.com

MISC0201-G200R Iss.03
© QED Environmental Systems Ltd.

GLOSSARY OF TERMS

Analyser error messages	For a list of standard error codes and for more information, please refer to section Problem Solving of the operating manual.
Analyser warnings	There are two types of warning messages displayed; general warnings that may not necessarily affect the instrument's function, for example battery power low, and operational parameters that could affect the performance of the analyser, for example CO ₂ out of calibration.
Analyser Data Manager	Analyser Data Manager software enables the operator to maximise the operation of the instrument. Instrument readings and event log data can be downloaded to a PC for further analysis.
Area mode	'Area' is the soft-key used to begin operating in area or room monitoring mode. This mode automatically stores a rolling average N ₂ O reading every 15 minutes. G200 only.
Backlight	LED illumination of the LCD display, turns off after 30 seconds, pressing any key relights the display.
Battery charge	A full battery charge will take approximately four hours.
Calibration	The process that an instrument will undergo to enable it to measure and display the various parameters in accordance with the manufacturer's specification.
Chemical cell	Type of gas detector which can be fitted internally to the analyser at the time of manufacture.
Clean air purge	Process used to clear out gas from the inlet pipe and the analyser's gas sensors prior to taking a new reading.
CO	Carbon monoxide gas.
CO ₂	Carbon dioxide gas.
Contrast adjustment	Adjustable setting which darkens or lightens the text displayed on the screen. Typically, this is used to compensate for different environmental temperatures. High temperature causes the display to darken and low temperature causes the display to lighten.
Data logging	A mode of operation that enables the user to leave the analyser unattended to take readings automatically at predetermined times. The reading interval and pump run-time may be adjusted prior to

	commencing the logging cycle.
Download	Terminology used to describe the transfer of data from the analyser to a PC via Analyser Data Manager.
Event log	Record of significant events in the life of the analyser. Used as an aid to monitoring the use of the analyser. It can also be used as a diagnostic tool if there is a problem with the analyser. The event log can be viewed via Analyser Data Manager. It <u>cannot</u> be viewed on the analyser screen.
Exhaust port	The point at which the gas exits the analyser. This is located on the top of the analyser. It is threaded to take an M5 hose-barb to allow an exhaust tube to be attached if required.
Exhaust tube	Clear plastic tubing used to route gases from the exhaust port.
Factory settings	Default calibration settings preset at time of factory calibration.
Firmware	Firmware is the name given to the analyser's internal software. This can be programmed using the re-flash command on Analyser Data Manager. The latest software release can be downloaded from the QED website. It is also automatically updated when the analyser is returned for servicing.
General warnings	Displayed throughout the documentation with a warning symbol. Warning information may affect the safety of users.
Inlet port	Port located on the top of the analyser to which the inlet tube is attached.
Leak mode	'Leak' is the soft-key used to begin operating the instrument in leak detection mode. This extends the range of the N2O sensor up to 10,000ppm and speeds up the response time to enable it to indicate the current level of N2O. G200 only.
LCD display	Liquid Crystal Display. Fitted to the front panel of the analyser.
Main Read Screen	The main analyser screen for normal operations and all operations are carried out from this screen.
Memory	The analyser memory should not be used as a permanent storage medium and data collected should be transferred using Analyser Data Manager.
N ₂	Nitrogen gas.

Operating Manual

N ₂ O	Nitrous oxide gas.
O ₂	Oxygen gas (typically 20.9% in air, measured via electro-chemical cell).
OEL	Occupational Exposure Limits.
Over range codes	Over range codes are errors above the maximum allowed reading and will be displayed with more than chevrons (>>.>).
Person mode	'Person' is the soft-key used to begin operating in personal safety monitoring mode. This mode automatically stores an average N ₂ O reading every 15 minutes. G200 only.
ppm	Parts per million.
Predetermined	Set up prior to use via Analyser Data Manager software.
Pressure	Maximum input pressure 250mb maximum flow 300ml.
Pump	The device used to transfer a gas sample into the instrument where that sample is not under pressure. Select the 'Pump' key on the analyser to activate.
Regulator flow	The regulator's flow is factory set. It only requires a few turns to open, no adjustment is available.
Sample tube	Tube used to transfer sample gas from the source to the analyser.
Soda lime CO ₂ filter kit	Removes CO ₂ when taking a reading. Must be fitted on the G200 model.
Span	The point at which the gas analyser is calibrated when a known concentration of the target gas is present.
TWA	Time Weighted Average.
Under range codes	Under range codes are errors below zero and will be displayed with less than chevrons (<<.<).
User calibration	Users have the facility to calibrate the analyser between services. User calibration of the gas analyser will improve the data accuracy in the range of the calibration gases used.
Warm-up self-test	Predetermined self-test sequence to test the analyser functions which takes place after the analyser is switched on and lasts approximately 30-40 seconds.
Warranty	The instrument is guaranteed against defect in materials and workmanship for a period of 12 months

Zero

from the date of shipment to the user and is subject to the recommended service and recalibration requirements.

The point at which the gas analyser is calibrated when there is none of the target gas present.