

INSTALLATION INSTRUCTIONS

ESP M2/M4 mains protectors

ESP 415 M2, ESP 415 M4, ESP 480 M2,
ESP 480 M2 and M2R/M4R variants



Contents

Key points of installation	1
Before installation	2
Installation	3
Installation check (LED units)	4
Neutral-earth warning light (LED units)	5
Status indication (LED units)	6
Status indication (LCD units)	7
Remote indication	8
Maintenance	9
Application Notes	10
Remote display drilling template	11

INTRODUCTION

This document explains how to install Furse Electronic Systems Protectors for three phase mains power supplies:

**ESP 415 M2 & ESP 415 M2R, ESP 415 M4 & ESP 415 M4R,
ESP 480 M2 & ESP 480 M2R, ESP 480 M4 & ESP 480 M4R**

These instructions are prefaced by a summary of the **Key points of installation**. Each key point is explained in detail in the section entitled **Installation**.

Installation instructions

ESP M2/M4 mains protectors



Safety note:

Warning! Installation by person with electrotechnical expertise only.

Warnung! Installation nur durch elektrotechnische Fachkraft.

Avvertenza! Fare installare solo da un elettricista qualificato.

Avertissement! Installation uniquement par des personnes qualifiées en électrotechnique.

Advertencia! La instalación deberá ser realizada únicamente por electricistas especializados.

ESP protector installation should be conducted by a qualified competent person and comply with all relevant Regulations and Legislation (including BS 7671 Wiring Regulations and Building Regulations). Incorrect installation will impair the effectiveness of ESP protectors.

Always handle cables by their insulation. Never work on ESP protectors, earthing or their cables during a storm.

Installation instructions

ESP M2/M4 mains protectors

1. Key points of installation

- 1.1 Install protectors very close to the power supply to be protected, either within the distribution panel or directly alongside it.
- 1.2 Mount units within a panel or WBX enclosure.
- 1.3 Units are installed in parallel.
- 1.4 Connect to phases, neutral and earth.
NOTE: Units must have a neutral connection (see 3.4).
- 1.5 Units installed at power distribution boards can be installed either:
 - on the load side of the incoming isolator, or
 - on the closest available outgoing way to the incoming supply
- 1.6 Provide a means of isolation for the ESP unit.
- 1.7 The connecting leads to phase/live terminals should be suitably fused, ensuring full discrimination with the immediate upstream supply fuse. Use:
 - up to 200 A fuses with the ESP M2/M2R (supply fused at ≥ 400 A)
 - up to 315 A fuses with the ESP M4/M4R (supply fused at ≥ 630 A)

Installation instructions

ESP M2/M4 mains protectors

- 1.8** Connecting leads should be no less than 16 mm² multi stranded copper conductor. Terminals can accept up to 25 mm² multi-stranded cable.
- 1.9** Keep the connecting leads as short as possible and ideally less than 25 cm (10 inches) in length. This may be better achieved with the equivalent M2R or M4R remote display variant which permits optimum positioning of both protector and display.
- 1.10** Bind the connecting leads tightly over their entire length.

Installation instructions

ESP M2/M4 mains protectors

2. Before installation

2.1 Check that the voltage between neutral and earth does not exceed 10 Volts. If this voltage does exceed 10 Volts, the installation is unsafe.

Find and rectify the cause of this fault before proceeding (for delta supplies with no neutral, see 3.4).

2.2 Make sure that the supply voltage is suitable for the unit.

	Supply Rated Voltage (VRMS)	Unit VoltageRange (VRMS)
ESP 415 M2/M2R, or ESP 415 M4/M4R Phase to Phase	380/400/415	346-484
ESP 480 M2/M2R, or ESP 480 M4/M4R Phase to Phase	480	402-600

Installation instructions

ESP M2/M4 mains protectors

3. Installation

3.1 Location

Protectors need to be installed very close to the power supply to be protected. Usually the protector will be installed at a power distribution panel either inside it or right next to it.

3.2 Enclose the ESP unit

The ESP unit has exposed terminals. For electrical safety, the unit must be installed within a panel or enclosure. For standard single and three phase units, where possible, install the unit within the power distribution panel behind a suitable viewing window.

Alternatively, for three phase units, a remote display (M2R or M4R) option is available. M2R and M4R units can be installed within the power distribution panel with the remote display mounted on the front of the panel (for drilling template, see page 23).

The remote display has an IP rating of IP20 as standard, which can be increased to IP64 through addition of a neoprene seal (ESP accessory ESP RDU-SEAL).

For remote display connection, ensure the cable is of sufficient length, and is unimpeded within the cabinet.

Allow a minimum of 60 mm behind the front panel for the interconnection cable. M2R/M4R units are supplied with 1 m interconnection cable as standard, with a 2 m or 4 m cable available as an option (contact Furse).

Installation instructions

ESP M2/M4 mains protectors

When mounting the units in existing metal panels or enclosures, ensure that the enclosure is securely bonded to the earth bar to which the ESP unit will be connected.

If it is not possible to install the unit within the distribution panel it should be mounted in a separate enclosure, as close as possible to the distribution panel (see 3.9 - Length of connecting leads). Gland the enclosure onto the power distribution panel. Suitable enclosures are available from Furse.

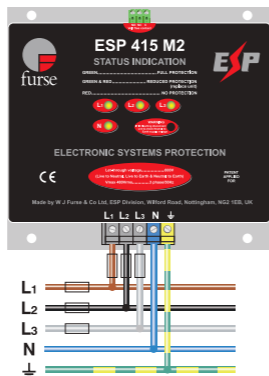

Figure 1:
Parallel connection for
three phase star (4 wire &
earth) supplies.

**From
supply**

**To
load**

Installation instructions

ESP M2/M4 mains protectors

3.3 Parallel connection

ESP mains wire-in protectors are connected in parallel with the supply to be protected. See Figure 1. **The connecting leads do not carry the load current of the supply**, only the current associated with suppressing the transient overvoltage. Connecting leads to the unit need to be kept short in order to minimise additive inductive voltages.

3.4 Connection to phase, neutral and earth

Connections are made to each supply conductor including earth. Terminals marked L1, L2, L3, N, \perp must be connected to phase/live, neutral and earth respectively.

Under no circumstances must the ESP unit be installed without connection to its neutral.

Where no neutral is present (eg delta supplies) the neutral (N) terminal on the ESP unit must be connected to the earth (\perp) terminal. This will result in a greatly increased earth leakage current. On some delta supplies the voltage between phase and earth/neutral may exceed the rating of the ESP unit. Consequently, the supply's phase to earth voltage must be checked before installing the ESP unit.

We recommend that you consult Furse ESP before installing ESP units on delta supplies.

Installation instructions

ESP M2/M4 mains protectors

Maximum torque is 2.65 Nm for power terminals, with cable stripping length 17 mm. The torque rating for the volt-free contacts is 0.25 Nm and cable stripping length 7 mm.

3.5 Connection point

(a) Protecting supplies feeding equipment in the building

The ESP unit is typically connected to the power supply at a power distribution board/panel, either:

- (i) on the load side of the incoming isolator (Figure 2).
- (ii) on the closest available outgoing way to the incoming supply
(ie the incoming isolator).

The ESP unit can be connected via one of the distribution board's outgoing fuseways or circuit breakers. **Ideally, the ESP unit should be connected to the outgoing way which is nearest to the incoming supply (or isolator).** See Figure 3.

On small, compact, metal cased distribution boards, (such as small MCCB boards) the first way is preferable, although any outgoing way is suitable.

On a large board such as a cubicle switchboard, it is better to install the protector on the load side of the incoming isolator (eg in the metering section) for optimal protection.

- (iii) directly to the busbars via suitable HRC fuses,

Installation instructions

ESP M2/M4 mains protectors

switchfuses or MCCBs - See section 3.7.

Figure 2:
ESP unit mounted within a distribution board connected to the incoming supply on the load side (ie downstream) of the isolator.

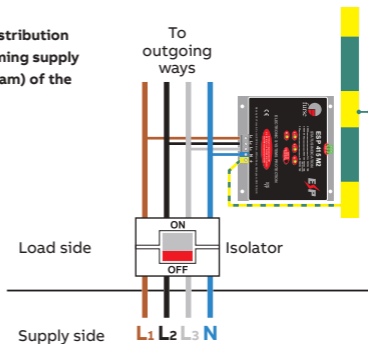

(b) Protecting supplies going out of the building

The connection methods 3.5a (i to iii) are not suitable for protecting a power distribution board which provides a supply to outside the building - either to a separate building or some other external load (eg site lighting).

To protect the equipment inside the building, from transient overvoltages entering the board on the outgoing feed, protection should be installed close to the external load. See Figure 4.

Installation instructions

ESP M2/M4 mains protectors

Figure 3:

Three phase ESP protector connected to the nearest available (MCCB) way to the incoming supply. The MCCB also provides the means of isolation. Since there is insufficient space within the distribution board the ESP unit has been mounted within a separate enclosure, directly alongside the board. (Note the additional earth bond from the enclosure's metal baseplate to the metalwork of the distribution board. This technique is explained in 3.9(ii).)

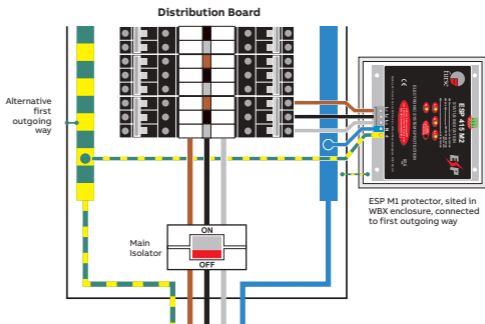

3.6 Isolation

It is good practice to be able to isolate or disconnect the ESP unit from the supply. The supply to the entire distribution board should not be switched off on many computer power supplies and other critical loads.

Installation instructions

ESP M2/M4 mains protectors

Figure 4:
Connection for supplies continuing external to the building (protector within separate enclosure).

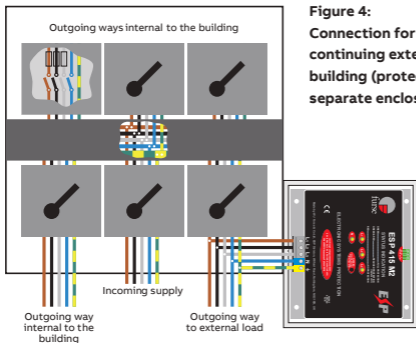

The means of isolation should therefore be installed in the connection to the ESP unit. Figures 5 & 6 show example connection schematics. Where it is also necessary to fuse the connection to the ESP unit (see 3.7 Fuse connecting leads) this can be achieved through use of a switchfuse or MCCB.

3.7 Fuse connecting leads

The connecting leads to the phase/live terminals of the ESP units should be fused. This is to protect the connecting leads in the event of a short circuit. The fuse to the ESP unit (FSPD) should be lower than the upstream supply fuse FS by a sufficient enough factor to ensure fuse discrimination. As a general guide a factor of at least 2 could be used ($F_{SPD} \leq 0.5 FS$), where the maximum fuse to the ESP unit required is:

Installation instructions

ESP M2/M4 mains protectors

- 200 Amps for ESP M2/M2R (if the supply fuse is 400 Amps or greater)
- 315 Amps for ESP M4/M4R (if the supply fuse is 630 Amps or greater)

Figure 5:

ESP unit installed on incoming side of distribution board fused with up to 200 Amps (ESP M2/M2R) or up to 315 Amps (ESP M4/M4R)

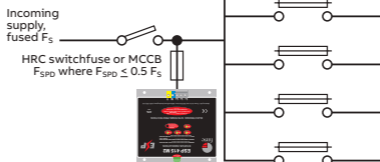
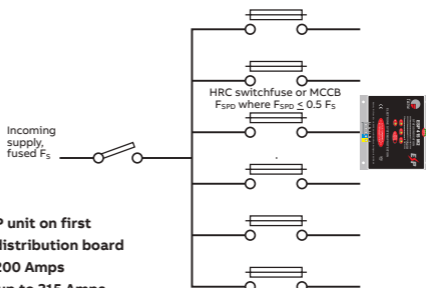

Figure 6:

Installation of ESP unit on first outgoing way of distribution board fused with up to 200 Amps (ESP M2/M2R) or up to 315 Amps (ESP M4/M4R)



Installation instructions

ESP M2/M4 mains protectors

Refer to the fuse manufacturer's operating characteristics to ensure discrimination, particularly where an installation includes a mixture of types of fuse, or of fuses and circuit breakers.

Live/phase connecting leads can be fused by either:

- installing appropriate high rupture capacity (HRC) fuses or switchfuses in the connecting leads at the supply end of the lead (See Figure 7), or
- installing an appropriate MCCB.

Where the ESP unit is installed via an outgoing way (3.5b earlier) this should incorporate a 200 or 315 Amp (as appropriate) HRC fuse or MCCB.

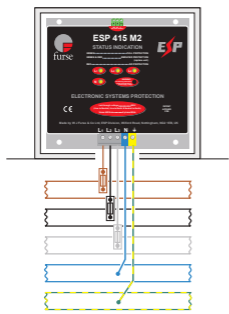

Figure 7:
Busbar mounted HRC fuse at the end of the live connecting lead.

Installation instructions

ESP M2/M4 mains protectors

3.8 Size of connecting leads

The connecting leads between the terminals of the ESP unit and the power supply, should be multi stranded conductor no less than 16mm² (copper). If required, the terminals on the ESP unit will accept connecting leads of up to 25 mm².

3.9 Length of connecting leads

The connecting leads should be kept as short as possible and ideally should not exceed 25 cm (10 inches) from the busbars to the unit's terminals. **ESP units can be mounted upside down or on their side if this facilitates shorter connecting leads.**

ESP protectors with remote display units (M2R and M4R variants) allow the protector to be mounted with short connecting leads whilst allowing the display to be positioned independently (eg conveniently on the front of the panel). The display is connected to the protector via the supplied 1 m cable (2 m or 4 m cable optional - contact Furse). The remote display drilling template can be found at the back of these instructions.

Installation instructions

ESP M2/M4 mains protectors

WARNING: The longer the connecting leads (between the mains cable or busbars and the terminals of the ESP unit) the greater the additive voltage let-through by the installed protector. If the resultant let-through voltage is higher than the susceptibility level of the equipment to be protected, damage will result.

An earth connection of more than 25 cm is acceptable when it is supported by a secondary earth connection, either:

- (i) within the panel or distribution board when the protector's base is securely bolted to the metal of the board (and is in good electrical contact with it) and this is bonded to the earth bar (see Figure 2).

- (ii) outside the panel or distribution board when the protector's base is securely mounted to (and in good electrical contact with) the metal base plate of a WBX enclosure and this is bonded to the panel chassis (Note: the panel chassis must be bonded to the distribution board's earth). See Figure 3.

3.10 Bind connecting leads

Connecting leads should be tightly bound together using Ty-Raps®, tape or spiral wrap. This should be done for the entire length of the cable or as far as is possible.

Installation instructions

ESP M2/M4 mains protectors

4. Installation check

The ESP unit should now be correctly installed. Switch the power supply on. Check that a green LED per phase and neutral is lit. See Figure 8. The unit is now fully operational.

Watch the WARNING light for 30 seconds.

If it is flashing or lit there is a problem with your installation (see opposite).



Figure 8:
Status indication lights showing full protection on all phases. On M2R and M4R units, status indication is shown on the remote display unit.

Installation instructions

ESP M2/M4 mains protectors

5. Neutral-earth warning light

If the WARNING light is illuminated there is an excessive voltage present between neutral and earth.

The WARNING light should never be illuminated.

(a) Illumination at time of installation

If the WARNING light flashes as soon as the mains supply to the ESP unit is turned on, one of the phase/live cables may have been connected to neutral and the neutral to phase/live.

Isolate or disconnect the ESP unit immediately. Check the phase/live and neutral connections and if a mistake has been made, correct it. If all the phase/live and neutral connections are correct, there is a fault with the mains supply (see (b) - below). Note: The ESP unit may have suffered damage - check the status indication (see page 18).

(b) Illumination at any time

The WARNING light will flash when the neutral to earth voltage exceeds 30 Volts. The faster the flashing, the higher the voltage between neutral and earth (at very high voltages the WARNING light may appear to be permanently illuminated).

Disconnect the ESP protector immediately and check the mains supply. The ESP protector should not be reconnected until the cause of the fault has been identified and rectified.

Note: The ESP unit may have suffered damage - check the status indication (see page 18).

Installation instructions

ESP M2/M4 mains protectors

6. Status indication

ESP units give a continuous visual display of their status. They have a two colour indicator light, for each phase and neutral:

Green only = Full protection, power on.

Green + Red = WARNING. Reduced protection, replace unit as soon as possible.

Red only = NO PROTECTION. Replace ESP unit immediately.

No lights = No power connection or system fault. Check external fuses and connections.

Installation instructions

ESP M2/M4 mains protectors

7. Remote indication

A remote indication of the reduced protection state is provided for linking the protector to a building management system, remote telemetry, PLC or directly to an indication light or buzzer.

The unit has both a normally open and a normally closed volt free contact. The terminal for the volt free contact accepts 1.5 mm² cable (solid or stranded conductor) and is located on the top of the ESP unit. It has three terminals, marked:

NO = Normally Open **NC** = Normally Closed **C** = Common

The normally open (NO) contact is open when the ESP unit is healthy and power is present.

The normally closed (NC) contact is closed when the unit is healthy and power is present.

As well as providing warning of the reduced protection state, the normally closed volt free contact can also be used to signal power loss on one or more phases, eliminating the need for special relays. See Figure 9.

The ESP units remote indication is rated at 1 Amp, 250 V AC.

Note: For reliable contact operation, the minimum permissible load is 10 mA, 5 V DC.

Installation instructions

ESP M2/M4 mains protectors

	Unit Healthy		Reduced or No protection	
	NO	NC	NO	NC
Power Present	OPEN	CLOSED	CLOSED	OPEN
Power Absent	CLOSED	OPEN	CLOSED	OPEN

Figure 9:
Operation of normally closed (NC) and normally open (NO) volt free contact.

The maximum torque rating for the terminals is 0.25 Nm, with a cable stripping length of 7 mm.

Installation instructions

ESP M2/M4 mains protectors

8. Maintenance

Maintenance should be conducted at least once a year and also following lightning activity. Visually check:

- Visual status indication lights (see Status indication for interpretation)
- Condition of connecting leads and terminations

Environment

Consider the protection of the environment!

Used electrical and electronic equipment must NOT be disposed of with domestic waste. The device contains valuable raw materials which can be recycled. Therefore, contact ABB for disposal of this equipment.



Installation instructions

ESP M2/M4 mains protectors

9. Application notes

9.1 ESP coordination

ESP M2/M2R or ESP M4/M4R units are designed to fully coordinate with downstream ESP unit of equivalent system voltage. For example the ESP 415 M2 located at the main distribution panel would coordinate effectively with the ESP 415 M1 unit typically located at sub-distribution panels. No additional decoupling elements such as inductors are needed to ensure ESP units achieve coordination.

Always ensure ESP units are used on the same installation to ensure coordination. Mixing ESP units with alternative manufacturers' units could result in damage to both protection units and connected equipment through poor coordination.

9.2 RCD units

ESP units should ideally be installed before (or upstream of) residual current devices (RCDs) and not on the load side. ESP units should only be installed on the load side of the RCDs if the load in question is external to the building.

This should help to reduce any spurious tripping of such devices due to transient overvoltages. Special transient hardened RCDs (type 'S') can be obtained from a number of manufacturers.

Installation instructions

ESP M2/M4 mains protectors

9.3 Insulation tests (flash testing)

The ESP unit should be fully disconnected from the circuit before testing. Otherwise the ESP unit will treat the insulation test as a transient overvoltage and control the voltage to a low level - thereby defeating the object of the test.

9.4 Duplex configuration

For systems demanding extremely high reliability, ESP units can be connected in duplex format. The use of two units will achieve an improvement in performance and increased lifetime over a single ESP unit at high discharge current levels. Each unit should have its own (separate) wiring and its own isolation.

If possible the two units should be connected to the power supply a short distance apart either:

(a) onto the first two outgoing ways

(b) up to a metre apart on the incoming power supply.

Installation instructions

ESP M2/M4 mains protectors

9.5 Installing three phase units on single phase supplies

If a three phase unit is installed on a single phase mains supply (or a supply in which one or two phases are not in use), the ESP units spare (or unused) live terminal(s) should be connected to live, otherwise its indication lights and volt free contact will not work correctly. The preferred approach is to take a connecting lead from each spare terminal to the supply live. However, it is also possible to connect the ESP units spare terminal(s) to whichever live terminal is in use at the unit.

9.6 Use of powered screwdrivers

The use of powered screwdrivers is not recommended unless measures are taken to ensure screws are tightened correctly and not damaged.

Installation instructions ESP M2/M4 mains protectors

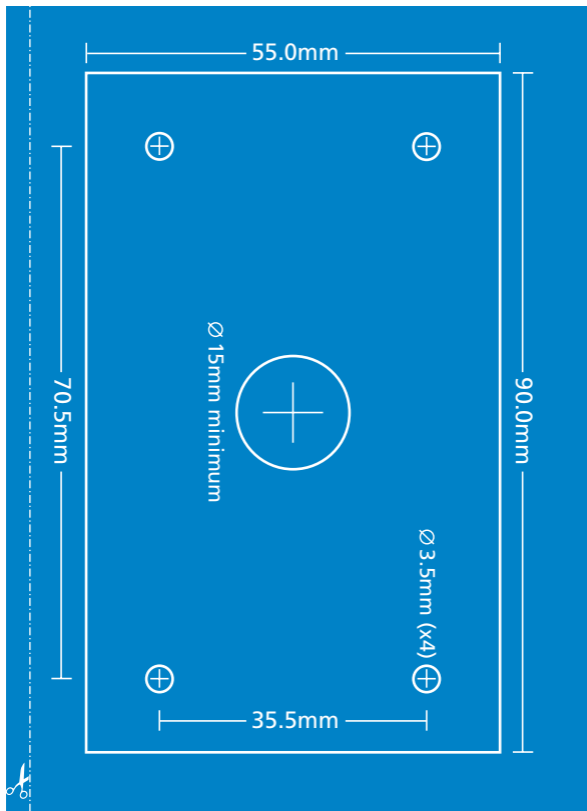

sales@norrscope.com