



Honeywell

PolyGard® 2 Multi Gas Controller MGC2-K

Controller for Analog Sensors / Honeywell Sensors

User Manual

Version 26.03 2020 en



1	Intended Use.....	4
2	Functional Description	4
2.1	General	4
3	Installation	5
3.1	Mounting Instructions.....	5
3.2	Installation Work	5
4	Electrical Connection	6
4.1	Wiring.....	6
4.2	Wiring Diagrams	7
5	Intended Use for the Display Unit.....	8
6	Description	8
7	Operation	8
7.1	Function of the Keys and LEDs on the Keypad.....	8
7.2	Setting / Changing of Parameters and Set Points	9
7.3	Code Levels	9
8	Menu Overview.....	10
8.1	Fault Management.....	12
8.1.1	Error Memory	12
8.1.2	System Messages and System Errors.....	12
8.2	Alarm Status	13
8.3	Relay Status.....	13
8.4	Menu Measuring Values	14
8.5	Display Parameters	14
8.5.1	Software Version.....	14
8.5.2	Language	15
8.5.3	Service Phone Number	15
8.5.4	Customer Password.....	15
8.5.5	Error Time Delay	15
8.5.6	LCD Function	16
8.6	Menu Relay Parameters	16
8.6.1	Relay Mode	16
8.6.2	Relay Operation Mode	16
8.6.3	Relay Function Static / Flashing.....	17
8.6.4	Alarm Quantity.....	17
8.6.5	Horn Function.....	17
8.6.6	External Override	18
8.6.7	Delay Mode of Alarm Relay	19
8.6.8	Assignment to Fault	19
8.6.9	Assignment to Maintenance Message	19
8.7	MP Parameters	20
8.7.1	Activate – Deactivate MP	20
8.7.2	Selection of Gas Type and Measuring Range	20
8.7.3	Alarm Thresholds / Hysteresis	23
8.7.4	Delay for Alarm ON and/or OFF.....	24
8.7.5	Average Overlay	24
8.7.6	Latching Mode Assigned to Alarm	24
8.7.7	MP Fault Assigned to Alarm.....	25



8.7.8	Alarm Assigned to Alarm Relay	25
8.7.9	MP Assigned to Analog Output	25
8.8	Menu System Parameters	26
8.8.1	System Information	26
8.8.2	Maintenance Interval	26
8.8.3	Average Function	26
8.8.4	Power On Time	27
8.8.5	Deadband	27
8.8.6	AO Function	28
8.8.7	Relay Multiplication	29
8.9	Operating Data	30
8.10	Test Function for Relays	31
8.11	Test Function for Analog Output	32
8.12	Calibration	33
8.12.1	Zero Calibration of Analog Output	34
8.12.2	Calibration of the Digital Sensors	34
8.12.3	Credit Menu	34
8.13	Setting RS-485 Address	34
9	Commissioning	35
9.1	General Notes	35
9.2	Visual Inspection	35
9.3	Selection Gas Type with Unit	35
10	Configuration and Parameter Cards	36
10.1	Configuration Card System Parameters	36
10.2	Configuration Card Alarm Relays / Signal Outputs	36
10.3	Configuration Card MC2 of Analog Measuring Points	37
11	Routine Maintenance and Scheduled Testing	38
11.1	Routine Maintenance	38
11.2	Routine Testing	38
12	Technical Data MGC2	39
13	EC – Declaration of Conformity	40
14	Part Disposal	41
15	Notes and General Information	41
15.1	Installers' Responsibilities	41
15.2	Disclaimer	41
15.3	Warranty	42
15.4	Copyright Notice	42



1 Intended Use

The PolyGard®2 MGC2 is designed for detection and warning detection of toxic, combustible or dangerous atmosphere in many commercial and industrial applications.

The intended sites are all areas being directly connected to the public low voltage supply, e.g. residential, commercial and industrial ranges as well as small enterprises (according to EN50 082).

The PolyGard®2 Multi Gas Controller MGC2 must not be used in potentially explosive atmospheres. The sensor must only be employed in areas within the environmental conditions specified in the Technical Data.

2 Functional Description

2.1 General

The Multi-Gas-Controller is designed for the connection of max. three analog sensors with 4-20 mA signal and eight Honeywell sensors.

The controller monitors the measured values and activates the alarm relays if the set local alarm thresholds for pre-alarm and main alert have been exceeded or if there are the alarm messages coming from the eight digital sensors via RS-485 communication.

The SIL 2 compliant self-monitoring function in the MGC2 activates the fault message in case of an internal error as well as in case of a fault at the 4-20 mA input / output current signals or if there is a communication error to the digital sensors.

Other options such as three-color status LED, warning buzzer, digital input for acknowledgment or test function ensure proper adaptation to the wide range of applications in gas detection technology.

3 Installation



Electronics can be destroyed by electrostatic discharge (ESD). Therefore, the installation work should be done only by persons connected to ground, e. g. with a wrist strap connected to ground or by standing on a conductive floor (acc. to DIN EN 100015).

3.1 Mounting Instructions

When choosing the mounting site please pay attention to the following:

- Choose mounting location of the sensor according to the local regulations.
- Mount the sensor at a location with minimum vibration and minimum variation in temperature (avoid direct sunlight).
- Avoid locations where water, oil etc. may influence proper operation and where mechanical damage might be possible.
- Provide adequate space around the sensor for maintenance and calibration work.
- Observe possible local instructions.

3.2 Installation Work



Assembly work must only be carried out under gas-free conditions.

Do not drill holes in the housing. Use only the providing know-outs.

- Open housing cover.
- Break out the required pre-embossed knockouts on the housing for cable glands and Sensor Cartridge.
- Cables are introduced from above.
- The MGC2 Controller is fixed to the wall through the four marked mounting points at the back side of the housing. These mounting points are accessible after opening the housing. See figure below.
- The dimensions XX depend on the type and can be read on the back of the housing, it is 115 mm.
- The mounting points are covered by closing the cover at the end of the assembly.
- Close the cover.

Installation of Controller:

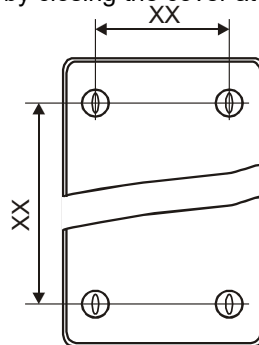

4 Electrical Connection



Assembly work must only be carried out under gas-free conditions!
Consider static electricity instructions (ESD)!

4.1 Wiring

- The technical requirements and regulations for wiring, electrical safety, as well as project specific and environmental and local conditions etc. must be observed when mounting.
- We recommend the following cable types¹:

	Europe	USA / Canada
Power supply 230 V	NYM-J 3 x 1.5 mm ²	14 AWG / 300 V
Alarm message 230 V (also possible together with power supply)	NYM-J X x 1.5 mm ²	14 AWG / 300 V
Signal message, bus connection, warning devices 24 V	J-Y(St)Y 2x2 x 0.8 mm ²	min. 300 V
Possibly connected external analog transmitters	J-Y(St)Y 2x2 x 0.8 mm ²	min. 300 V

¹ The recommendation does not consider local conditions such as fire protection etc.

- Use copper conductors only for the terminal is only for connection to copper wire.
- Avoid any influence of external interferences by using shielded cables for the bus line, but do not connect the shield.
- Remove the cable isolation as short as possible. It is important to ensure that bare wires, e.g. wire shields do not come into contact with the mounted PCB (risk of short-circuit).
- Low voltage wire and mains connected wire must be fixed separately by cable ties or similar, to secure against looseness.
- Analog sensors are connected directly to the spring type terminals of the module. The correct polarity must be observed.
- The alarm signals are available as voltage-free change-over contacts. If required, the voltage supply is available at the terminal L.

The exact position of the terminals for the sensors and alarm relays is shown in the connection diagrams.

4.2 Wiring Diagrams

Wiring Diagram Example

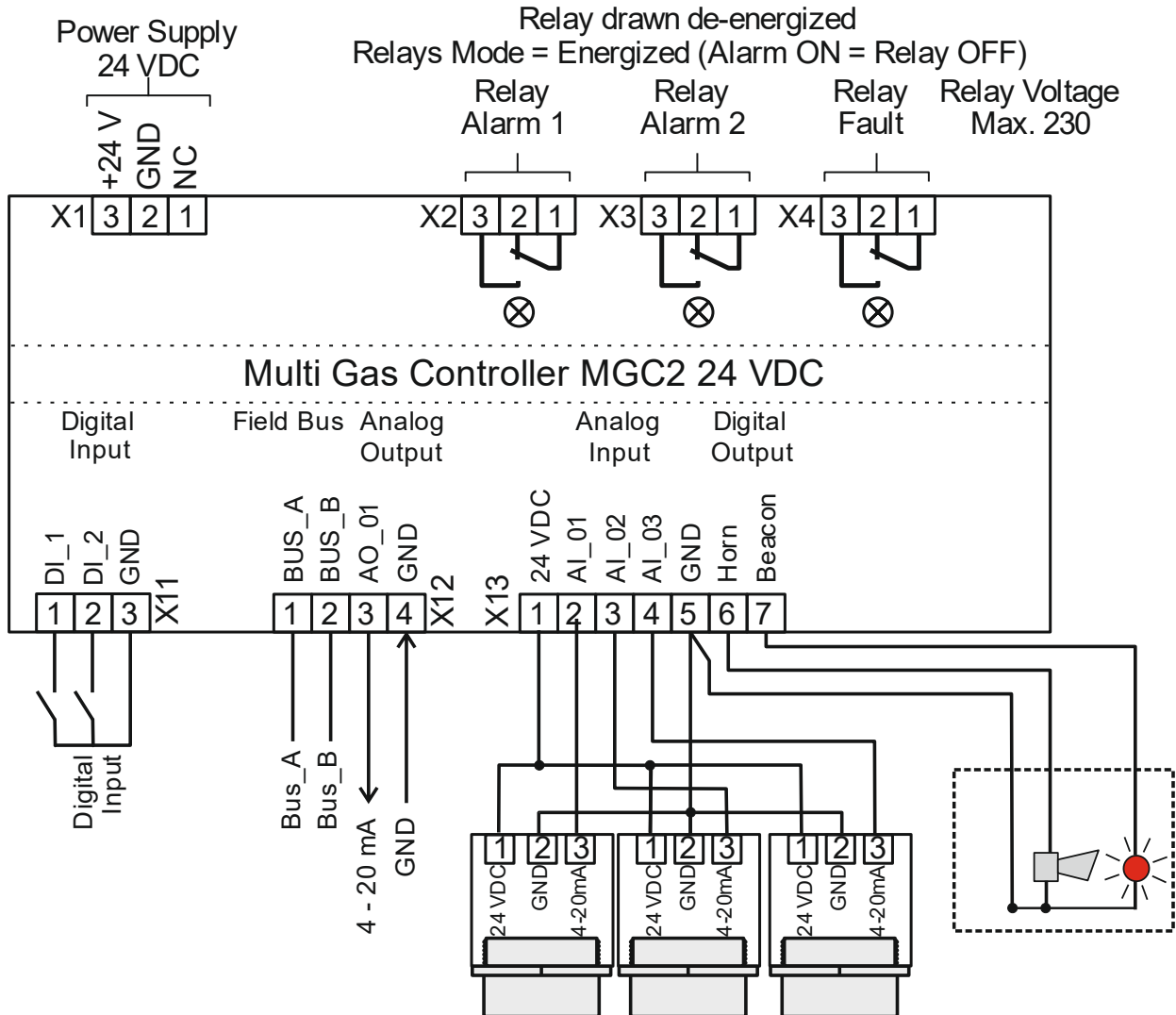

Display Unit for Series MGC2-K

5 Intended Use for the Display Unit

The display is used as visual indication, operating, commissioning and calibration unit for gas detecting and measuring instruments of the series PolyGard®2 (PG2).

6 Description

The parameters, gas types, units, etc. specified in the description are only examples.



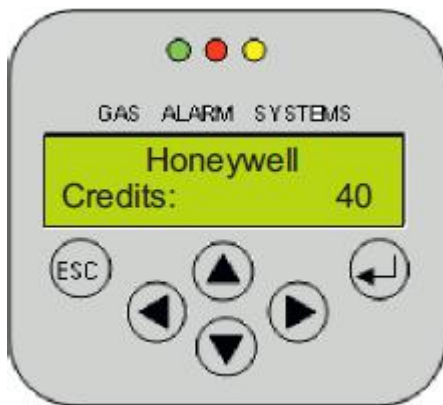

7 Operation

The complete configuration and service are made via operating keys in combination with the LCD display screen. Security is provided via four password levels against unauthorized intervention



Version for PG2 series
Operation via 6 buttons

7.1 Function of the Keys and LEDs on the Keypad

-  Exits programming, returns to the previous menu level.
-  Enters sub menus, saves parameter settings.
-  Scrolls up & down within a menu, changes a value.
-  Changes cursor position.

The status LEDs indicate the operating state.

Green: Continuous: = Normal operation
Flashing: = Maintenance message

Yellow: Continuous: = Failure
Slowly flashing: = Warming-up
Fast flashing: = Special mode

Red: =Alarm

The backlight of the display changes from green to red when an alarm is active.

PolyGard® is a registered trademark of MSR

GAMGC2-K_E_0320

7.2 Setting / Changing of Parameters and Set Points



Open desired menu window.
Code input field opens automatically, if required.

After input of valid code, the cursor jumps onto the first position segment to be changed.



Push the cursor onto the position segment, which has to be changed.



Set the desired parameter / set point with the keys.



Input of value finished.



Change further parameters in the same menu.



Save the changed value?



YES, and back to higher menu level.



NO, (previous value isn't overwritten) and back to higher menu level.

7.3 Code Levels

All inputs and changes are protected by a four-digit numeric code (= password) against unauthorized intervention according to the regulations of all national and international standards for gas warning systems. The menu windows of status messages and measuring values are visible without entering a code.

The access to a code level is cancelled if no button is pushed within 15 minutes or if there is no data communication between display and basic board.

The code levels are classified in order of priority: Priority 1 has top priority.

Priority 1: (code not changeable)

Code level priority 1 is intended for the service technician of the installer to change parameters and set-points. This password allows working on all settings. For opening the parameter menus, you must first activate the service mode after code release.

Priority 2: (code not changeable)

This functionality isn't available.

Priority 3: (customer password is settable)

Customer password is inactive in delivery state and is activated by entering a value. Same behaviour as priority 1 password, only changing the customer password is not possible.

Normally the code is only known by the service technician who has last changed it since it can be changed individually via priority 1.

Priority 4: (password 1234) (code not changeable)

Code level priority 4 allows the operator after activation of the operation mode "Service Mode" to read all parameters as well as all test functions of the alarm relays, analog outputs and LCD.

- Manual test function of the alarm relays (functional test of the connected actuators),
- Manual test function of the analog outputs (functional test of the connected actuators),
- Manual test function of the LCD (functional test of the LCD display and the LEDs).



8 Menu Overview

Menu operation is done via a clear, intuitive and logical menu structure. The operating menu contains the following levels:

- Starting menu with indication of the device type if no MP (Measuring Point) is registered. Otherwise scrolling display of the gas concentrations of all registered sensors in 5-second intervals. If alarms are active, only the values of the sensors currently in alarm status will be displayed.
- Main menu
- Submenu 1 to 3

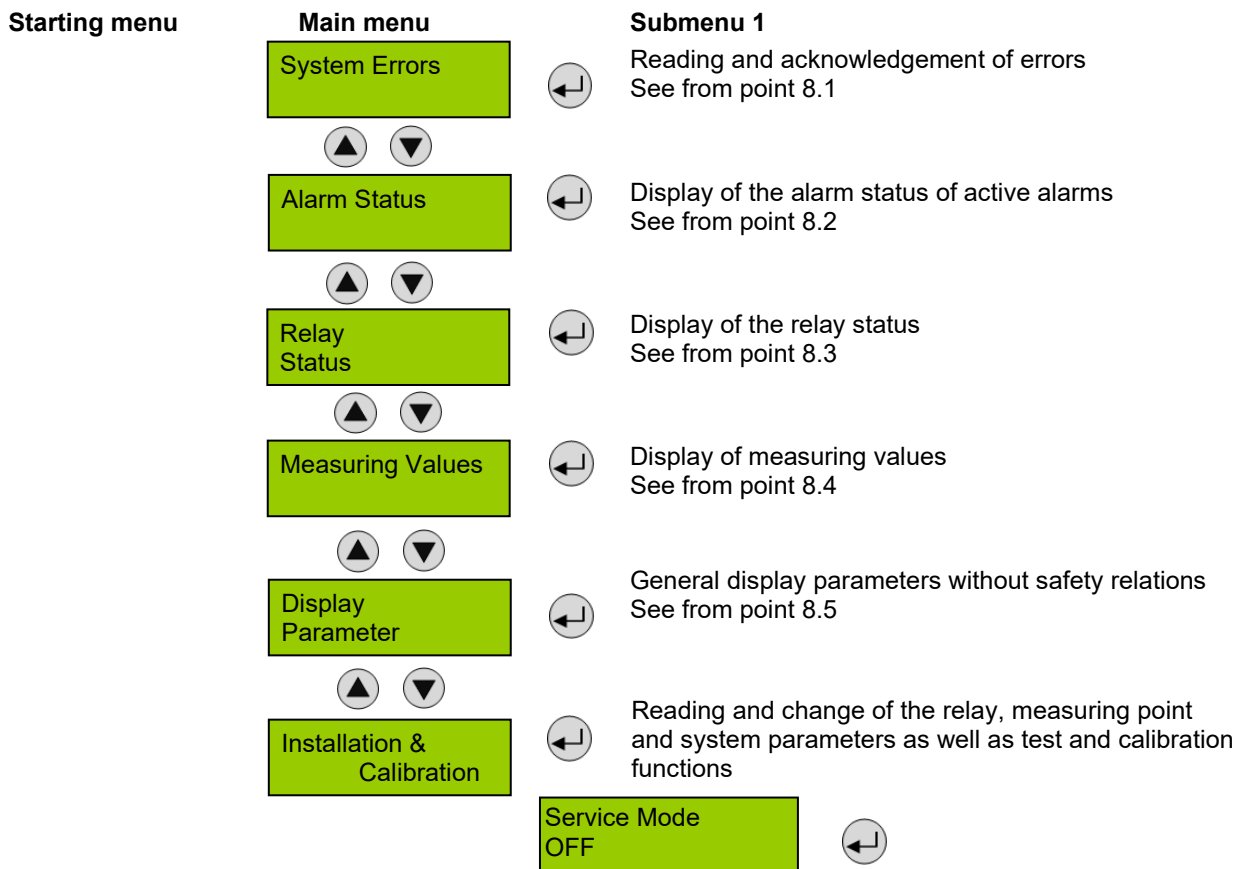
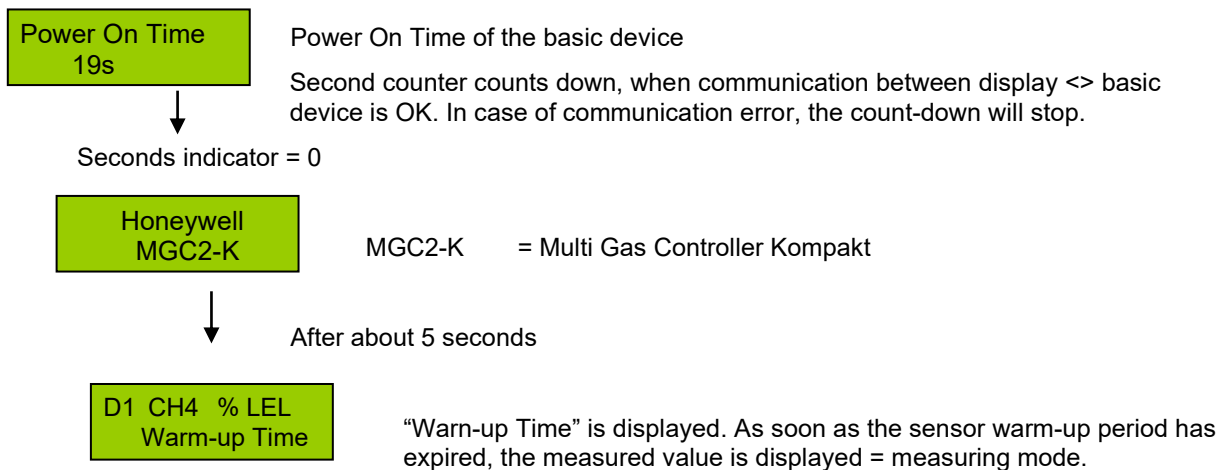

The following menu items are only accessible in Service ON mode (password protected)

!! Service ON = Special mode = Fault message is active!!

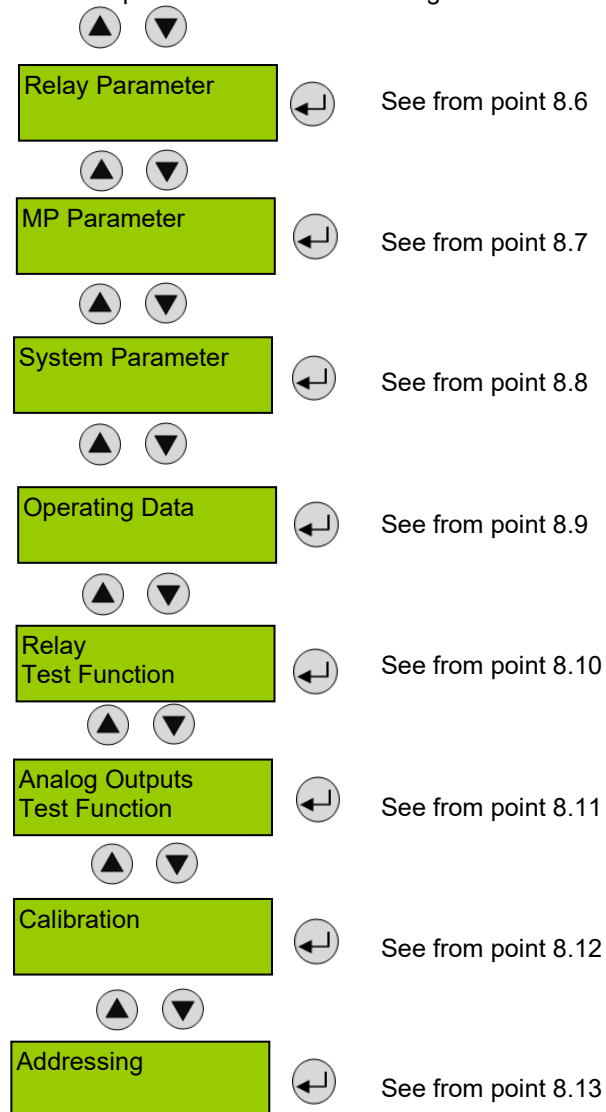

8.1 Fault Management

A pending fault activates the yellow LED (Fault).

The integrated fault management records the first 50 occurred faults with time stamps in the menu "System Errors". The timestamp shows the days, hours and minutes that have elapsed since the fault has occurred.

MP 1 Comm.Error
1 1T 2h 6'

Additionally, a record of the faults occurs in the "Error memory", which can only be read and deleted by the service technician (code level 1 (3)).

8.1.1 Error Memory

The menu "Error Memory" in the main menu "System Errors" can only be opened via the code level priority 1.

In the error memory, the first 50 faults that have occurred and have already been acknowledged in the menu "Error Status" are listed for the service technician in a power failure safe way.

Attention:

This memory should always be read during maintenance, relevant faults should be tracked and entered in the service logbook, and finally the memory should be emptied.

8.1.2 System Messages and System Errors

The warning device includes a diagnostic module for the continuous monitoring of the relevant functions and parameters as well as a processor-independent watchdog. These features set the device into the safe mode "Fault" in case of an internal or external error. The following table shows all possible errors, possible causes, the related troubleshooting and the resulting device status.

Once the cause has been eliminated, the warning device restarts with the diagnostic mode on its own. It isn't necessary to acknowledge the error message. In the event of an error, the error is output as plain text in the version with display instead of the measured value and in the Error status menu. In case of two or more errors, the value is output with a cumulative, bit-coded error code.

Error Type	Cause	Remedy	Fault Relay	Analog Output	Centr. Bus	Display	
						Error Code	Text Mess.
Error messages from MGC2							DP1-
Sensor element defective		Replace sensor	Error	< 2 mA	Error code is sent	0x8 001 h	Sensor
Temperature < -25 °C > +60 °C	Ambient temp.	Temp.!	Error	< 2 mA	Error code is sent	0x8 002 h	Overtemp.
Measured value processing	Internal	Replace device				0x8 002 h	ADC error
RAM / ROM / µC error						0x8 008 h	CPU error
EEPROM error						0x8 010 h	EE error
No response alarm relay						0x8 020 h	I/O error
Deviation of analog output signal < 5 % >	Short-circuit or Interruption at the analog output	Check wiring / load	Error	X mA	Error code is sent	0x8 020 h	I/O error
	Internal	Replace device					
Communication error to sensor	Sensor head not fitted correctly	Check	Error	< 2 mA		0x9 000 h	Comm. error
	Internal	Replace Sensor					
Hardware Watch Dog triggered	Internal, < system voltage, µC defect.	Replace device	Error	< 1 mA	Comm. STOP	Reset	Reset
Operating voltage limits exceeded too high / too low	External	Check voltage	Error	< 2 mA	Comm. STOP	0x8 008 h	Tension
	Internal	Replace device					
Maintenance due	Maintenance date reached	Perform maintenance	No effect			0x8 080 h*	Maintenance

8.2 Alarm Status

Display of the currently pending alarms in plain text in the order of their arrival. Only those measuring points are displayed, where at least one alarm is active.

Alarms in latching mode and the overrange message can be acknowledged in this menu (only possible if the alarm isn't active any more).

Alarm 1 and Alarm 2 are evaluated both by the sensor (alarm bit transmitted by communication) and by the locally set thresholds.



Symbol	Description	Function
AP 1	Measuring Point No.	Analog measuring point 1 = 1 - 3, where an alarm is pending
DP 4	Measuring Point No.	Digital measuring point 4 = 4 - 11, where an alarm is pending
'A1 "A1	Alarm status	'A1 = Alarm 1 active "A1 = Alarm 1 in latching mode, can be acknowledged

8.3 Relay Status

Reading of the current status of alarm relays.

The actual relay status is displayed, depending on the relay mode (energized <> de-energized).

Selection of the alarm relay 1 – 5

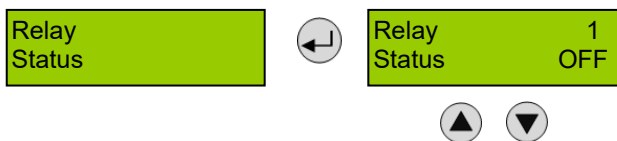

Selection of the next alarm relay

Symbol	Description	Function
1	Alarm Relay	Alarm relay = 1 - 5
OFF	Relay Status	Deenergized
ON	Relay Status	Energized

8.4 Menu Measuring Values

In this menu, the display shows the measuring value with gas type and unit. If the alarm evaluation is defined via the average, the display additionally shows the average value (A) to the left of the current value (C).

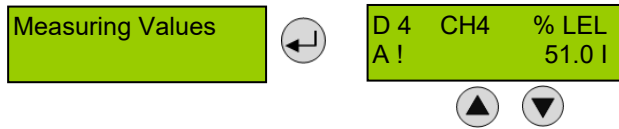

Selection of the next measuring point

Symbol	Description	Function
A 1 ¹	Meas. Point No.	Analog measuring point 1 to 3
D 4 ¹	Meas. Point No.	Digital measuring point 4 to 11
CH4	Gas type	Display of gas type (must comply with gas type of sensor head)
% LEL	Gas unit	Unit (depending on gas type)
51,0 C 48,0 A	Measured value	C = Current measured value (current value) of the gas concentration A = Arithmetic average of the gas concentr. (only if average is active)
A!	Alarm indication	At least one alarm has been released at this MP.
#	Maint. info	Sensor head: maintenance due (maintenance date exceeded)
Comm. err.	Fault MP	Communication error, sensor head <> I/O board
Underrange	Meas. range monitoring	Meas. signal < admissible range (< zero point – 6 %)
Overrange ²		Meas. signal > admissible range (> full scale value + 6 %)
Run-in	Run-in time	Warm-up of the sensor active

¹ Display of the address number the measuring range is registered under in the Modbus

² Acknowledgement in the menu Alarm Status

8.5 Display Parameters

In the menu Display Parameters, you can find the general, non-safety related parameters of the display. These parameters can be changed in operating mode.



8.5.1 Software Version



Software version of the display and of the basic board

Symbol	Description	Function
XXXXX	Software Version of the displays	XXXXX Software Version
YYYYY	Software Version of the basic board	YYYYY Software Version



8.5.2 Language

Language
English



Selection of the menu language (only code level 1 and 3)

Symbol	Description	Default	Function
English	Language	German	German English USA English French Italian

8.5.3 Service Phone Number

Service TEL:
0080081819691



The service phone no. can be individually defined.

Symbol	Description	Default	Function
00800...	Phone No.		Definition of the individual service phone no.

8.5.4 Customer Password

Storage of an individual customer password on the display for changing the parameters. See 7.3 Code level Priority 3. Changing the password only via access of the code level 1.

Change Customer
Password ****



8.5.5 Error Time Delay

Error Delay
0s

Symbol	Description	Default	Function
s	Delay	120s	Definition of a delay time after a communication error Display <> Basic Board has occurred (only fault indication on the display, no effect on the function or outputs)

8.5.6 LCD Function

LCD Function
check?

Testing the LCD hardware. Back-light is active for about 2 secs. The backlight is yellow. (Green and red are activated at the same time). All segments are active on LCD.



The following area is only accessible if the service is set to "ON".

- With code priority 4 for reading the parameters
- With code priority 1 or 3 for changing the parameters.

8.6 Menu Relay Parameters

Reading and changing of the parameters separately for each alarm relay.

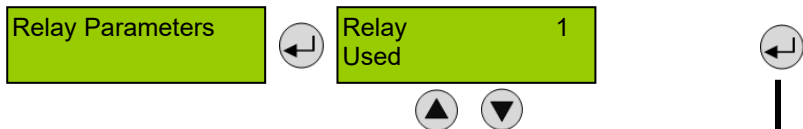

8.6.1 Relay Mode

Selection of alarm relay 1 - 5

The fault relay is listed as relay 3 and can be registered here as an additional alarm relay. This registration has no influence on the function as fault relay.
The relay switches off in addition when the assigned alarm is active.

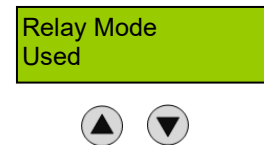

Symbol	Description	Default	Function
Used	Mode	Used	Used = Relay is registered and can be assigned to an alarm Not Used = Relay isn't registered

8.6.2 Relay Operation Mode

Relay 3:

The parameter setting "Energized" cannot be changed.

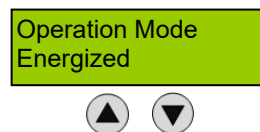

The terms energized / de-energized come from the terms "energized / de-energized to trip" principle used for safety circuits. The terms refer to the activation of the relay coil, not to the relay contacts (as they are executed as changeover contacts and available in both principles).

The LEDs at the modules show the state in analogy. (LED off -> relay coil current-free)

Symbol	Description	Default	Function
De-energ.	Mode	De-energ.	De-energ. = Alarm OFF = Relay (and LED) current-free Alarm ON = Relay (and LED) energized
			Energ. = Alarm OFF = Relay (and LED) permanently energized Alarm ON = Relay (and LED) current-free

8.6.3 Relay Function Static / Flashing

Relay 3:

The parameter setting "No" (cannot be changed).



The function "Flashing" offers a connection option for warning devices to improve visibility. The frequency is about 1 second with an impulse / pause rate of 1:1.

If "Flashing" is set, the output circuit mustn't be used as a safe output any more.

The combination of relay mode energized with flashing operation makes no sense and is therefore suppressed.

Symbol	Description	Default	Function
No	Function	No	Yes = Relay function flashing in case of alarm
			No = Relay function static in case of alarm

8.6.4 Alarm Quantity

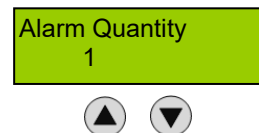

In some applications it is necessary that the relay switches only at the nth alarm. Here you can set the number of active alarms necessary for relay tripping. For safety related applications, the relay must always switch on the first alarm.

Symbol	Description	Default	Function
1	No. of Alarms	1	1 = Number of pending alarms for triggering the alarm relay

8.6.5 Horn Function

Relay 3:

The parameter setting cannot be changed.

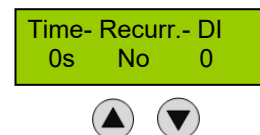

The horn function of the alarm relay is activated if at least one of the two parameters (time or assignment to digital input) is set. The horn function retains its functionality even for alarms in latching mode.

This feature is not allowed for safety-related alarm messages because the output is resettable.

Symbol	Description	Default	Function
Recurrence	Mode	No	No = Automatic reset of the relay after time has expired. Yes = Recurrence function
Time		0	Enter time for automatic reset function or recurrence function in s 0 = No reset function
DI		0	0 – 2 = Assignment, which digital input resets the relay

Horn function resettable:

The activated horn can be reset with this function.

The following possibilities to acknowledge are available for the alarm relay as horn relay:

- By pressing the left button (ESC). Only available in starting menu.
- Automatic reset at the end of the preset time (active, if value > 0).
- By an external pushbutton (assignment of the appropriate digital input DI 1-n).

Due to fixed polling cycles, external buttons must be pressed for a few seconds before the reaction occurs.

After successful acknowledgment the horn remains permanently reset until all assigned alarms for this relay function are inactive again. Only then it is triggered anew in case of an alarm.

Acknowledge the horn relay

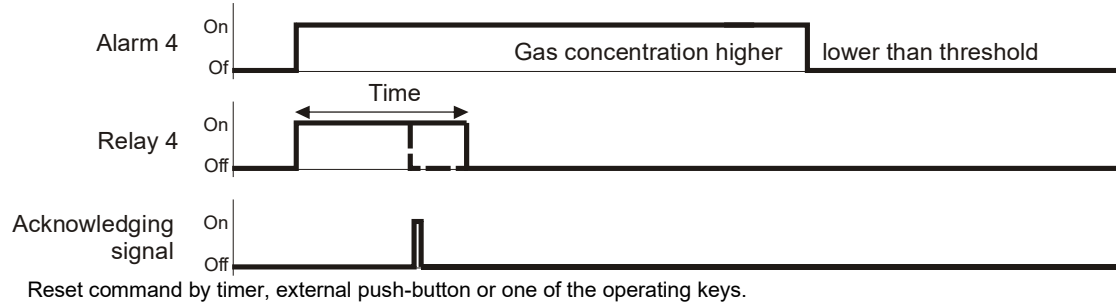

Recurrence of the horn relay

After an alarm has been triggered, the horn will remain active until a reset action is done. After acknowledgment of the horn relay (via a button or externally via digital input) a timer starts. When this time has run out and the alarm is still acting, the relay is set again. This process is repeated endlessly as long as the associated alarm remains active.

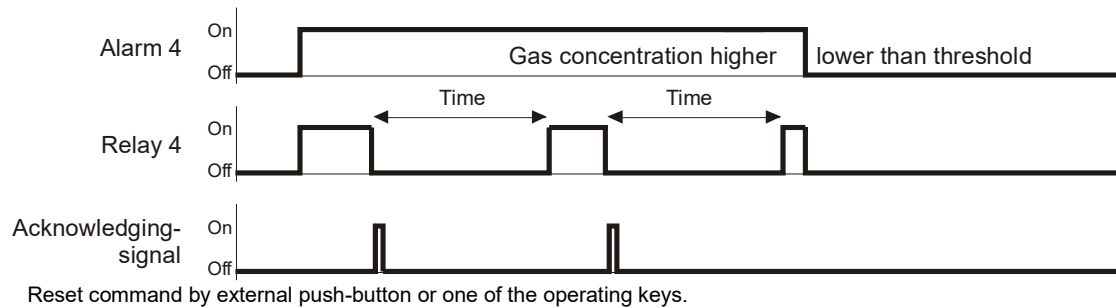



8.6.6 External Override

Relay 3:

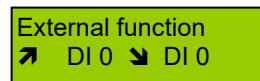
The parameter setting cannot be changed.



Symbol	Description	Default	Function
 DI 0	External ON	0	As long as DI 1-X is closed, relay switches ON
 DI 0	External OFF	0	As long as DI 1- X is closed, relay switches OFF.

Manual operation of the alarm relays via DI does not start the "special mode", as this is a deliberate and configured functionality. The use of the override should be used with caution, particularly the function "External OFF".

Assignment of a digital input (DI) for the external alarm relay switching on/off.

This function has priority to gas alarm.

If External ON and External OFF are configured to the same relay and both are active at the same time, so in this state, the External OFF command has priority. In this mode, too, the relay works respecting the parameter settings "Static / Flashing" and "Energized / De-energized".

8.6.7 Delay Mode of Alarm Relay

On Delay Time
0 s



Off Delay Time
0 s



Relay 3:

The parameter setting cannot be changed.

Definition of the time for switch-on and switch-off delay of the alarm relays.

Symbol	Description	Default	Function
0 sec.	Switch-ON Delay Time	0	≥ 1: Alarm relay is only activated at the end of the defined time. 0 = No delay
0 sec.	Switch-OFF Delay Time	0	≥ 1: Alarm relay is only deactivated at the end of the defined time. 0 = No delay

8.6.8 Assignment to Fault

Relay 3:

The parameter setting cannot be changed.

Fault → Active
No



In case of a device fault the alarm, relay is triggered in addition.

This relay output must not be used as a safe error output.

Symbol	Description	Default	Function
No	No assignment	No	Alarm relay is not activated in case of a device fault.
Yes	Assignment to fault	Yes	Alarm relay is activated in case of a device fault.

8.6.9 Assignment to Maintenance Message

Maintenance → Active
No



In case of a pending maintenance, the alarm relay is triggered in addition.

Symbol	Description	Default	Function
No	No assignment	No	Alarm relay is not activated in case of a maintenance message.
Yes	Assignment to maintenance	Yes	Alarm relay is activated in case of a maintenance message.

8.7 MP Parameters

This menu allows the parameters for each sensor (MP) to be reviewed or changed. A code level 1 password is required.



Selection of measuring point (1 – X)

8.7.1 Activate – Deactivate MP

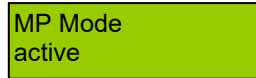

Every sensor needs to be active at the controller. After activation sensor signal will be displayed at the controller. Existing alarms and faults are cleared with deactivation of the sensor.

Analog input signals are reserved for MP1 to MP3. Up to eight further Honeywell bus sensors can be connected, here the address assignment starts with 4 and ends with 11.

Attention: The deactivated sensor does not cause a fault message.

Symbol	Description	Default	Function
active n. active	MP Mode	not active	active = Measuring point activated in the controller. not active = Measuring point not activated in the controller.

8.7.2 Selection of Gas Type and Measuring Range

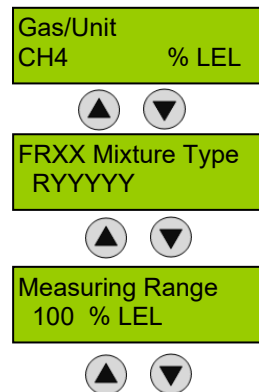

Menu only displayed if a Freon group is selected as the gas type. In the second line then the actual Freon name is entered. These Freons are listed in the following table under the Freon groups in the column FORMULA

Symbol	Description	Default	Function
CH4	Formula of Gas Type	----	Formula (gas type)
%LEL	Unit of Gas Type	----	Unit
100	Measuring Range	----	Set measuring range (must correspond with the sensor head).

The gas type to be monitored and the range are set in the two menus.

Ensure the controller setting is meeting the sensor setting.

Select the gas type; then the associated unit will appear on the right next to it.

The indication of measured values, alarm thresholds and hysteresis depends on the measuring range. If the measuring range is <10, there are three, if <100, there are two, if <1000, there is one decimal place. If => 1000, the display is without decimal place. The resolution and accuracy of the calculation is not affected by the different measuring ranges.

Please refer to the Honeywell sensor datasheets and sensor settings for the correct range. Please refer also the Honeywell Sensepoint XCL and Sensepoint XRL datasheet.



Table for example. The measuring range is configurable for each Gas Type (from 1 to 20000).

Gas Type	Formula	Meas. Range ¹	Unit
Carbon monoxide	CO	0-300	ppm
Nitrogen dioxide	NO2	0-30	ppm
Nitrogen monoxide	NO	0-100	ppm
Oxygen	O2	0-25	% Vol
Ammonia	NH3	0-300	ppm
Carbon dioxide	CO2	0-2000	ppm
Carbon dioxide	CO2	0-5	% Vol
Methane	CH4	0-100	% LEL
IR-Methane	CH4	0-100	% Vol
Propane	C3H8	0-100	% LEL
IR-Propane	C3H8	0-100	% Vol
Hydrogen	H2	0-100	% LEL
Ammonia	NH3	0-100	% LEL
Acetone	(CH3)2CO	0-100	% LEL
Benzene	C6H6	0-100	% LEL
Ethyl alcohol	C2H6O	0-100	% LEL
Ethyl acetate	CH3COOC2H5	0-100	% LEL
Ethylene	C2H4	0-100	% LEL
n-Butane	C4H10	0-100	% LEL
n-Heptane	C7H16	0-100	% LEL
n-Hexane	C6H14	0-100	% LEL
Isopropyl alcohol	(CH3)2CHOH	0-100	% LEL
JP8	JP8	0-100	% LEL
Methanol	CH3OH	0-100	% LEL
Methyl ethyl ketone MEK	C4H8O	0-100	% LEL
n-Octane	C8H18	0-100	% LEL
n-Pentane	C5H12	0-100	% LEL
Toluene	C7H8	0-100	% LEL
Butyl acetate	C6H12O2	0-100	% LEL
Cyclohexane	C6H12	0-100	% LEL
Cyclopentane	C5H10	0-100	% LEL
Ethane	C2H6	0-100	% LEL
Isobutanol / Isobutyl alcohol	C2H6 O2	0-100	% LEL
Methyl acetate	C3H6O2	0-100	% LEL
Nonane	C9H20	0-100	% LEL
LPG	LPG	0-100	% LEL
Petrol Vapours	Petrol	0-100	% LEL
Styrene	C8H8	0-100	% LEL
Xylene	C8H10	0-100	% LEL
Propane	C3H8	0-20000	ppm
Butadiene	C4H6	0-100	% LEL
Acetylene	C2H2	0-100	% LEL
VOC	VOC	0-2000	ppm
Xylene	C8H10	0-300	ppm
Sulphur hexafluoride	SF6	0-1000	ppm
Ethylene oxide	C2H4O	0-10	ppm
Bromine	Br2	0-2	ppm
Hydrogen fluoride	HF	0-10	ppm
Nitrous oxide	N2O	0-2000	ppm
Hydrogen cyanide	HCN	0-100	ppm
Formaldehyde	CH2O	0-10	ppm
Hydrogen chloride	HCL	0-20	ppm
Silane	SiH4	0-50	ppm
Ethylene	C2H4	0-1000	ppm
Ozone	O3	0-200	ppm
Chlorine	CL2	0-20	ppm

PolyGard® is a registered trademark of MSR

GAMGC2-K_E_0320



Sulphur dioxide	SO2	0-100	ppm
Hydrogen sulphide	H2S	0-200	ppm
Fluorine	F2	0-2	ppm
Phosphine	PH3	0-5	ppm
Hydrogen	H2	0-1000	ppm
Chlorine dioxide	ClO2	0-1 ²	ppm
Phosgene	COCl2	0-1 ²	ppm
FR01	R12	20 - 2000	ppm
FR02	R23 R508b	20 - 2000	ppm
FR03	R1234yf R452a R513a R454b R454c R455a R1234ze	20 - 2000	ppm
FR04	R123 R1233zd	20 - 2000	ppm
FR05	R11	20 - 2000	ppm
FR06	R22 R401a R401b R402a R402b R403a R408a R409a R411a	20 - 2000	ppm
FR07	R134a R407a R407f R416a R417a R422a R422d R427a E437a R438a R449a R450a	20 - 2000	ppm
FR08	R32 R125 R143a R404a R407c R410a R434a R448a R542b R507a	20 - 2000	ppm
Arsenic hydride	AsH3	0 -1 ²	ppm
Temp	Temp		°C
Temp	Temp		°F
Humidity	Hum.		% RH
Pressure	Press		mbar
TOX	TOX		ppm
Comb.	Comb		% LEL
External	External		%
Digital3	Digital		%

¹ Different measuring ranges are possible, but not listed here.

² The use with the measuring range value: 1 results in a binary value output of the values 0 or 1



8.7.3 Alarm Thresholds / Hysteresis

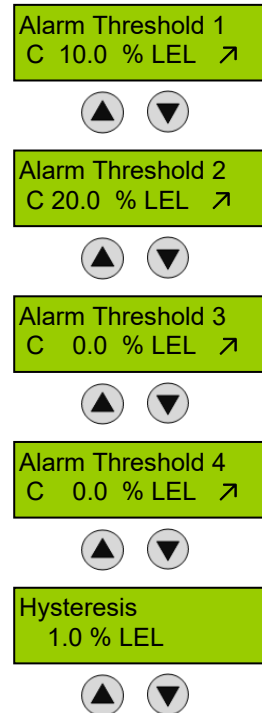

Symbol	Description	Default	Function
C	Evaluation	C	C = Alarm evaluation with current value of MP A = Alarm evaluation with average value of MP
10 % LEL	Threshold 1 Threshold 2 Threshold 3 Threshold 4 Hysteresis	XX XX XX XX XX	Gas concentration > Threshold 1 = Alarm 1 Gas concentration > Threshold 2 = Alarm 2 Gas concentration > Threshold 3 = Alarm 3 Gas concentration > Threshold 4 = Alarm 4 Gas concentration < (Threshold X –Hysteresis) = Alarm X OFF
↗		↗	↗= Alarm release at increasing concentrations ↘= Alarm release at falling concentrations

For each measuring point four alarm thresholds are available for free definition. If the gas concentration is higher than the set alarm threshold, the associated alarm is activated. If the gas concentration falls below the alarm threshold minus the hysteresis the alarm is reset again. In the mode “Alarm at falling” the corresponding alarm is set in case of falling below the set alarm threshold and reset again when exceeding the threshold plus hysteresis.

The presentation of the alarm thresholds depends on the set measuring range: See chapter Gas Type and Measuring Range.

The alarm thresholds are freely selectable in the range from 0 to 100 % of the measuring range.

The alarm threshold is only stored, if the value is \geq than the lower alarm threshold

Unused alarm thresholds have to be defined with 0, in order to avoid undesired alarms.

Higher-level alarms automatically activate the lower-level alarms.

Lowest hysteresis: 3 % of the lowest alarm threshold

Highest hysteresis: 50 % of the lowest alarm threshold



8.7.4 Delay for Alarm ON and/or OFF

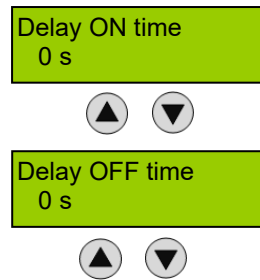

Symbol	Description	Default	Function
0 s	Delay Alarm	0 sec.	Gas concentration > alarm threshold + set time = Alarm ON Gas concentration < alarm threshold – hysteresis + set time = Alarm OFF

Function only active in Actual Value Mode.

8.7.5 Average Overlay



The function of the average overlay is only active for the gas type CO. The alarm evaluation of the operation mode "Average" is overridden by the current value, if this one exceeds the alarm threshold and delay time defined in the menu "System Parameters AV Overlay". The overlay is delayed by the time factor entered in the local menu.

Symbol	Description	Default	Function
No	Overlay of alarm release by current value	No	No = Average overlay not active. Yes = Average overlay active

8.7.6 Latching Mode Assigned to Alarm

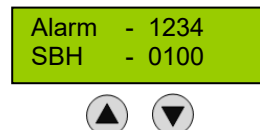

Note: SBH means Latching

In this menu you can assign the latching mode to each alarm.

Symbol	Description	Default	Function
Alarm			Indication of the alarms 1 to 4; under each alarm you can activate the latching with 1.
SBH	Assignment of latching function yes/no	0 0 0 0	0 = no latching; alarm resets automatically if gas concentration again < alarm threshold minus hysteresis 1 = latching; alarm remains active, if gas concentration < alarm threshold minus hysteresis, until reset by the operator.

The acknowledgment of an alarm in latching mode is carried out in the menu Alarm status. See chapter 4.2.

8.7.7 MP Fault Assigned to Alarm

Alarm - 1234
Fault - 0100



In this menu you can define, which alarms should be activated by a fault at the measuring point. If the fault is cleared, the alarm is automatically reset.

Symbol	Description	Default	Function
Alarm			Indication of the alarms 1 to 4; you can define with 1 for each alarm that the alarm should be activated in case of MP fault.
Fault	Assignment of MP fault to alarm	0 0 0 0	0 = Alarm isn't activated in case of MP fault. 1 = Alarm is activated in case of MP fault.

8.7.8 Alarm Assigned to Alarm Relay

A1 A2 A3 A4
1 0 0 0



Each of the four alarms can be assigned to any alarm relay 1 – 5 registered in the menu Relay Parameters by entering the relay address right under the alarm. One alarm relay can be assigned to multiple alarms. Unused alarms aren't assigned.

The fault relay can also be used for alarm message (address 3). The relay has to be registered in the menu Relay Parameters. The fault message function, however, remains unaffected.

Symbol	Description	Default	Function
Alarm	A1 A2 A3 A4		Presentation of the alarms 1 to 4; you can assign an alarm relay to each alarm by setting a relay address.
	Assignment of alarm relay	A1 = X A2 = X A3 = X A4 = X	X = Assignment of an alarm relay (relay address) to an alarm

8.7.9 MP Assigned to Analog Output

Analog Output
x



The measuring signal can be assigned to an analog output by entering the address of the analog output instead of x. The analog output is configured in the menu System Parameters, AO Function.

Symbol	Description	Default	Function
X	Address AO		X = Assignment of an analog output by entering the AO address

8.8 Menu System Parameters

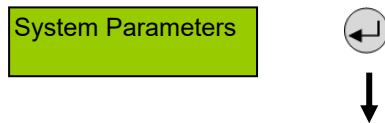

8.8.1 System Information

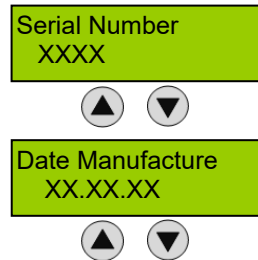

Symbol	Description	Default	Function
XXXX	Serial Number		Serial number (factory set)
XX.XX.XX	Date of Production		Date of production (factory set)

8.8.2 Maintenance Interval

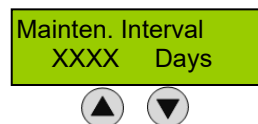

Input of the maintenance interval in days. If you enter < 10 days, the function is not active

The maintenance interval can be set on the basic unit for maintenance information on the connected analog inputs. If the maintenance interval is active, the accumulated maintenance message can only be acknowledged by a calibration (at the analog input or at the head).

Symbol	Description	Default	Function
XXXX	Days	0	Maintenance interval (range: 10 - 2480 days)

8.8.3 Average Function

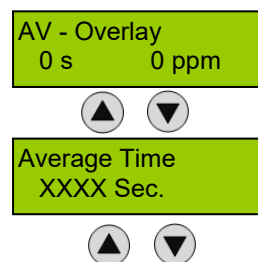

In the menu "Average Time" you can define the time base for the calculation of the arithmetic average value (30 measurements within the time base). This average value can be used for alarm evaluation as an alternative to the current value. The selection which value should be used for evaluation is defined separately for each alarm in the menu "Alarm Threshold X". In the average mode, the average value is indicated in the menu "Measuring Values" next to the current value.

The alarm evaluation of the operating mode "Average Value" is overlaid by the current value, when the current value exceeds the alarm threshold defined in the menu "AV-Overlay". The overlay is delayed by the time factor defined in this menu. The average overlay function is only available for the gas type CO.

Symbol	Description	Default	Function
XXXX	Seconds	900	Time base for average calculation (range: 0 – 9999 sec.)
0 s	Seconds	120	Delay time in case of overlay by the current value (range: 0 – 9999 sec.)
0 ppm	Alarm Threshold	100	Alarm threshold that triggers the overlay by the current value (range: 0 – 999 ppm)

8.8.4 Power On Time

Power On Time
30 s



Gas sensors need a warm-up time, until the chemical process of the sensor reaches stable conditions. During this running-in period the sensor signal can lead to an unwanted triggering of a pseudo alarm. Therefore, the Power On time is started at each basic unit and each sensor head after power-on or voltage recovery. While this time is running out, the device is in special mode and doesn't activate alarms. The Power On time appears in the starting menu. During this phase the sensor head transmits "Warm-up time" instead of the measured value.

The Power On Time of the individual components may be different. Only when the longest time has expired, the system starts the measuring operation.

Symbol	Description	Default	Function
XX	Seconds	30	Power On time (range: 0 – 999 sec.)

8.8.5 Deadband

Deadband
0 %



The unwanted noise of the measured value around the zero point, caused by the basic drift of the sensor, can be suppressed by activating a deadband with a range of 0% to 15% of the measuring range depending on device.

If the measured value is within the set % value, the display shows 0. Natural zero-point fluctuations of sensors downwards or upwards can thus be suppressed in the display. Default setting 0 means deadband deactivated.

The suppression also affects the analog output, because the measured value must not assume a different display depending on the output.

When opening the calibration mode, the deadband function switches off automatically.



8.8.6 AO Function

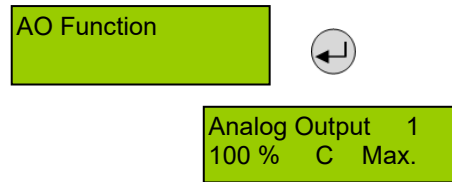

This menu is for the configuration of the analog output.

After registration, each analog output checks the current signal for plausibility. Signal deviations of more than 5% from the nominal value will generate an error message (causes: short circuit or interruption of cable, actuator not connected).

The steepness of the current signal can be adjusted in the range of 10 to 100% in case of local control.

If several measuring points are assigned, you can define whether the minimum, the maximum or the average of all the assigned signals is output. It is likewise possible to define which signal of the measuring points (source) is output.

If the 4 - 20 mA signal is used as a safe signal (SIL level), the following mandatory parameters must be used:

- Selection of analog signal: **100:** 100 % gas signal = 20 mA (standard signal)
- Selection source: **CF:** Source current value signal with fault message
- Selection of operating mode: **Max:** Output of the maximum value of the assigned MP

Symbol	Description	Default	Function
Analog Output 1	Selection of channel		Selection of the analog output 1 - X
0	Selection of output signal	100 %	0 = Analog output is not used, no monitoring of the feedback ≥ 10 = Local control and definition of the signal slope 10 = 10 % gas signal = 20mA (high sensitivity) 100 = 100 % gas signal = 20mA (standard signal)
C	Selection of source	A	C = Source is current value A = Source is average value CF = Source is current value and additional fault message at AO AF = Source is average value and additional fault message at AO
Max.	Selection of mode	Max.	Min. = Displays the minimum value of all assigned MP Max. = Displays the maximum value of all assigned MP Average = Displays the average value of all assigned MP

Note: If you use more than one oxygen sensor, please do not use the mA output function; please use only the relay functionality.



8.8.7 Relay Multiplication

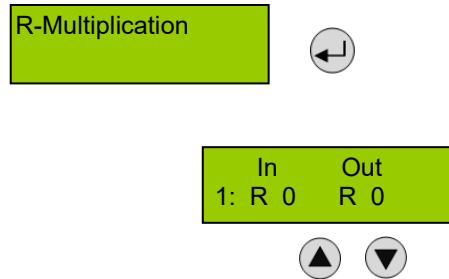

With the relay multiplication table, it is possible to assign an additional alarm relay to an alarm. This corresponds in the end to one multiplication of the source alarm situation per entry.

The additional relay follows the alarm status of the source but uses its own relay parameters to allow different needs of the doubled relay. So, the source relay can be configured, for example, as safety function in de-energized mode, but the doubled relay can be declared with flashing function or as horn function.

There is a maximum of two entries for IN relays and OUT relays. Thus, it is possible to expand one relay to two others or to double max. two relays.

In the column IN (source), you can set the relay assigned to an alarm in the menu MP Parameter.

In the column OUT (target), you can enter the relay needed in addition.

Note:

Manual intervention in the menu Relay Status or override in external ON or OFF by external DI do not count as alarm status, so they do only affect the IN relay. If this is also desired for the OUT relays, it has to be configured separately for each OUT relay.

Number	Description	Default Status	Function
0-5	IN AR Relay	0	0 = Function off X = Relay X should be multiplied (information source).
0-5	OUT AR Relay	0	0 = Function off X = Relay X (target) should switch together with IN relay.

Example:

2 relay contacts are needed with the same effect as relay 3, (see assignment of the relays in chapter MP Parameters.)

Entry: 1: IN AR3 OUT AR4
Entry: 2: IN AR3 OUT AR5

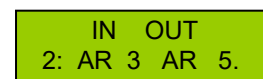
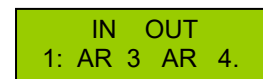

If relay 3 is activated via an alarm, the relays AR3, AR4 and AR5 will switch at the same time.



8.9 Operating Data

This menu is for retrieving relevant operational data of the sensor head and the basic unit. No changes or modifications are possible.

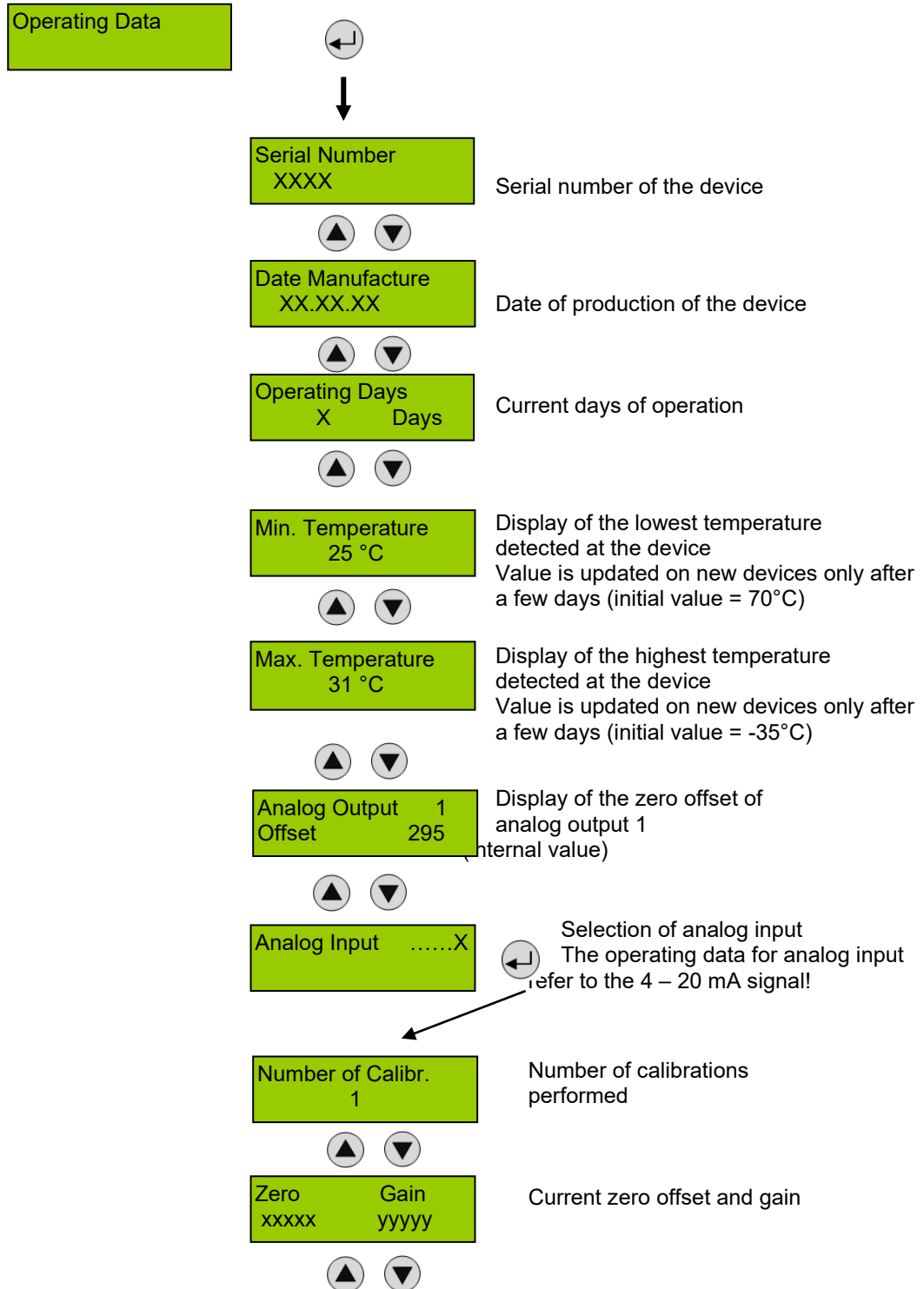



<div style="border: 1px solid black; background-color: #90EE90; padding: 5px; width: fit-content; margin: 0 auto;">Sensitivity 100%</div> <div style="display: flex; justify-content: center; gap: 10px; margin-top: 5px;"> ▲ ▼ </div>	Sensitivity of the analog sensor at the last calibration compared to new sensor (only for analog sensors)
<div style="border: 1px solid black; background-color: #90EE90; padding: 5px; width: fit-content; margin: 0 auto;">Maintenance Days Last xxx</div> <div style="display: flex; justify-content: center; gap: 10px; margin-top: 5px;"> ▲ ▼ </div>	Display of the days differing from the nominal maintenance date (fixed value)
<div style="border: 1px solid black; background-color: #90EE90; padding: 5px; width: fit-content; margin: 0 auto;">Days of operation Last xxx</div> <div style="display: flex; justify-content: center; gap: 10px; margin-top: 5px;"> ▲ ▼ </div>	Days of operation since the last calibration (fixed value)
<div style="border: 1px solid black; background-color: #90EE90; padding: 5px; width: fit-content; margin: 0 auto;">Maintenance Days Currently xxx</div> <div style="display: flex; justify-content: center; gap: 10px; margin-top: 5px;"> ▲ ▼ </div>	Currently remaining days until next maintenance date (down counter)
<div style="border: 1px solid black; background-color: #90EE90; padding: 5px; width: fit-content; margin: 0 auto;">Max. Current Value 0</div>	Maximum measured current value of the sensor head

8.10 Test Function for Relays

In this menu, the alarm relays can be manually turned on and off in order to test their function.

This menu is only available in special mode.

The manual operation takes priority over activation by a gas alarm. However, the external activation of the alarm relays via a digital input takes priority over the manual test function.

The test mode simulates an alarm for the relay and the relay accepts the alarm status. The test function is deleted by selecting "Automatic" or by exiting the Special Mode.

The testing is possible via code level 1, 3 and 4.

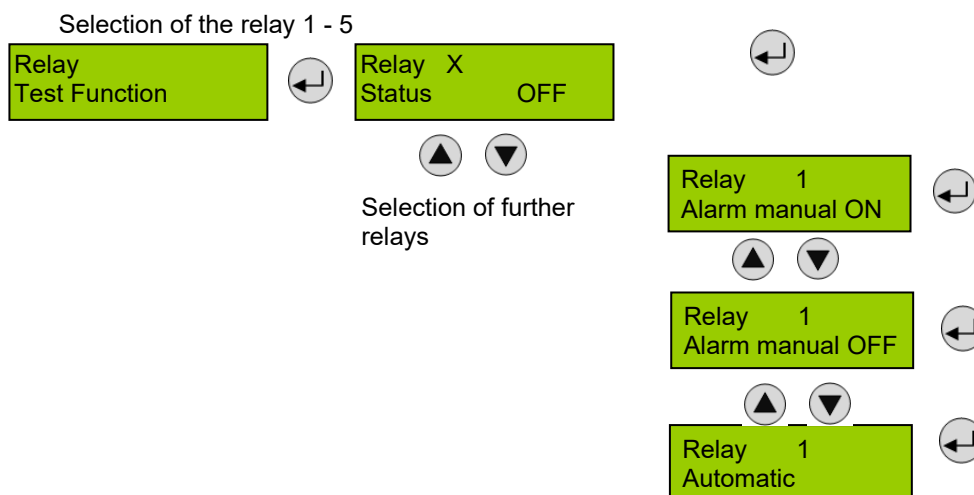

Symbol	Description	Default	Function
Status	Relay No. X		X = 1 – 5 Select the relay
OFF	Relay Status	OFF	Status OFF = Relay off (no gas alarm) Status ON = Relay on (alarm)
Alarm manual ON	Test of the alarm message	Autom	Alarm manual ON = Relay manually set in alarm status Alarm manual OFF = Relay manually set in “no alarm” status Automatic = Reset of manual intervention, relay in automatic mode

8.11 Test Function for Analog Output

In this menu, you can define a desired value in mA for the analog output in order to test its function. This value is then directly available at the output.

This menu is only available in special mode.

The manual operation has priority over the activation by the gas concentration.

The testing is possible via code level 1, 3 and 4.

When the menu is exited, the actual current signal is immediately output again, the entry field shows 0.

The test function is only possible for an active analog output.

Analog Output
Test Function

AO 1 Preset
4.02 mA 0.00 mA

On the left you can see the current set-point as calculated from the gas concentration.

AO 1 Set Value
4.02 mA 12.00 mA

Enter the required current under “Set Value”, e.g. 12 mA



AO 1 Set Value
12.00 mA 12.00 mA

The set value is accepted as set-point (by displaying it on the left) and is physically output.



8.12 Calibration

On this page there is the menu overview of the calibration. The calibration description can be found on the following pages.

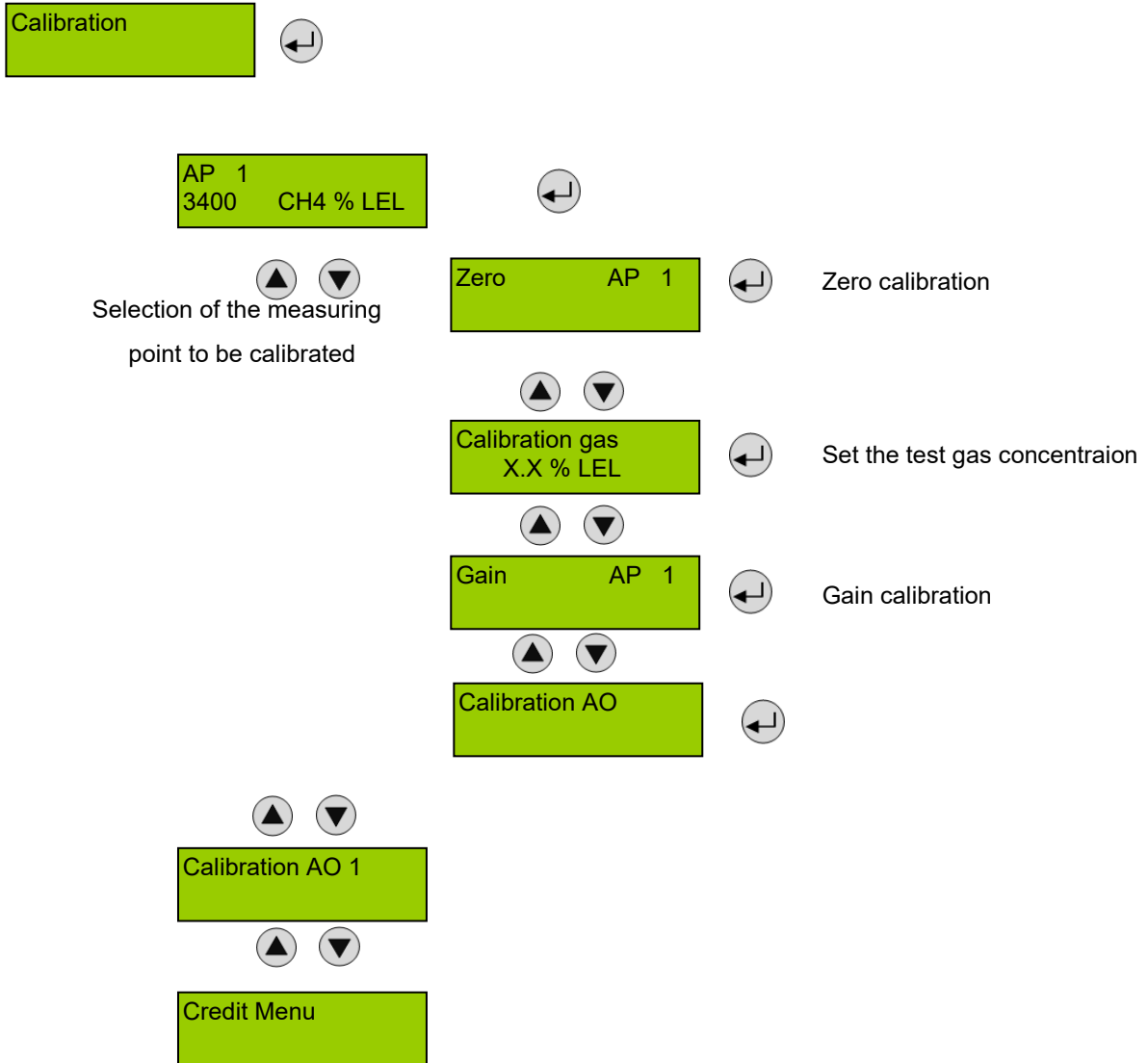

8.12.1 Zero Calibration of Analog Output

With this menu item you can correct the zero-point of the analog output (4mA). The zero-point correction is only possible when the analog output is in active mode.

The error message of the output monitoring is suppressed as long as the menu Calibration AO is open. Therefore, connect the Ampere Meter (measuring range 20 mA DC) to the analog output only after having opened the menu.

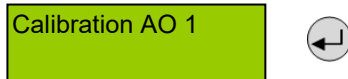

Connect amperemeter to the analog output.

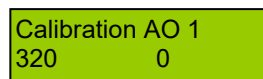

Display of the current zero offset on the left.

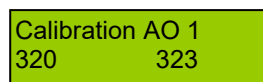

Adjust the zero offset on the right by changing the offset value slowly, until the amperemeter shows 4 mA.

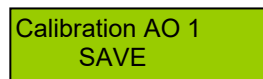

Save the adjusted zero offset.

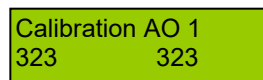

Return to the display of the current zero offset.

8.12.2 Calibration of the Digital Sensors

Please refer to Honeywell Disclaimer of the sensors.

8.12.3 Credit Menu

Display of current credits, loading new credits. Is required only for 4 – 20 mA inputs.

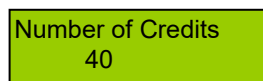
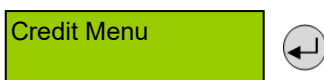

Display of number of current credits
If display is 0, calibration isn't possible any more.

8.13 Setting RS-485 Address

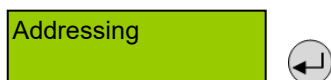

Assignment of the basis slave address of the device for field bus operation

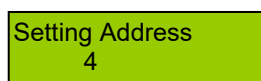

Define the basis slave address



9 Commissioning

9.1 General Notes

Only trained technicians should perform the following when commissioning:

- Check for correct mounting location.
- Check if connection is correct according to connection diagram.
- Check power voltage.

For fast and comfortable commissioning, we recommend proceeding as follows. For digital devices with self-monitoring all internal errors are visible via the LED. All other error sources often have their origins in the field, because it is here where most of the causes for problems in the field bus communication appear.

9.2 Visual Inspection

- Right cable type used.
- Correct mounting height according to definition in Mounting.
- Led status

9.3 Selection Gas Type with Unit

The selection of the desired and connected gas sensor type is made by pre-set values.

If other gas sensor types are connected, you have to adjust them with the display, because otherwise the device will show wrong measuring values.



10 Configuration and Parameter Cards

Commission:		Order number:	
Customer:		Service technician:	
Commissioning - company:		Date	

10.1 Configuration Card System Parameters

Serial No.	Date of Production	Mainten. interval	Mainten. Password	AV Overlay		AV Time	Power On Time	Error Time	CFM dupl.
				V-time	ppm				
Note	Note down	1900	****	V-time	ppm	900	30	30	0

Analog Output 1		
Outp.	Source	Oper.
Signal		Mode
100%	CV	AV

Relay Multiplication			
1		2	
In	Out	In	Out
0	0	0	0

10.2 Configuration Card Alarm Relays / Signal Outputs

Relay No.	active inactive	Mode	Stat. Flash	Reset	Horn	Extern. On	Extern. Off	Delay at ON	Delay at OFF	Fault ORed	Maint. ORed	
				Time	Recur.							DI
Default	inactive	de-en	Stat.	0	no	0	0	0	0	0	OFF	OFF
R 01												
R 02												
R 03												
Horn												
LED red												



10.3 Configuration Card MC2 of Analog Measuring Points

AP Nr.	MP Status	Locked	Gas type		Range	Alarm Thresholds				Hyst	AV-Delay Alarm (Sec)	at ON	at OFF	CV-AV	Assignment Latching				Assignment Fault <>Alarm				Assignment Alarm <> Alarm Relay				Ao1
			Gas	unit		A1	A2	A3	A4						A1	A2	A3	A4	A1	A2	A3	A4	A1	A2	A3	A4	
	inactive	No	CO2	ppm	300	30	60	120	120	15	0	0	AV	0	0	0	0	1	1	0	0	R1	R2	R3	R4		
A01																											
A02																											
A03																											
D04																											
D05																											
D06																											
D07																											
D08																											
D09																											
D10																											
D11																											



11 Routine Maintenance and Scheduled Testing

This chapter describes how to perform common maintenance operations and system testing. The required frequency of inspection and maintenance will depend on local site conditions and will need to be established through experience. Please refer to IEC/EN 60079-29-2 or other local or national regulations for guidance on establishing an appropriate maintenance routine.

11.1 Routine Maintenance

CAUTION

Test outputs will be generated, and relays will be activated during testing.

Ensure that relay activated output systems (i.e. emergency deluge / sirens etc.) are isolated before starting the Relay and mA Output tests.

CAUTION

While an Operator could Force a channel, a Service password is required to isolate services, carry out tests, Clear Force, and restore the system to full operational status.

For these reasons Operators should carry out visual inspections and cleaning only, unless under the direct supervision of the Service engineer.

Weekly Checks

- Visually inspect all cables and conduits for loose connections, security of attachment, and signs of damage.
- Wipe the PolyGard®2 Multi-Gas Controller with a soft damp cloth or use PC Screen cleaner.
- Check for dust contamination.
- Periodically exercise the outputs to confirm their functionality (see Caution above).

11.2 Routine Testing

It is normal practice to sound site alarms weekly, both to check they work and to accustom personnel to the sound they make.

As it involves isolating / inhibiting emergency systems during testing, it might be more prudent to test the PolyGard®2 relays and mA output only on a planned monthly basis.

Always have alternative safety arrangements in place and alert your personnel before and during testing.

Exercising the Audio/Visual Alarms

Audio/visual alarms can be tested by switching the Dedicated Alarms On.

Exercising the Relays

If the relays are switching main voltages, hazardous live terminals may be present. Ensure that all mains current is isolated and dissipated before touching live terminals.

Relay output channels can be tested by forcing the relays to an active state.

Checking the mA Output

Milliamp (mA) output can be tested by forcing the mA output.

Mandatory Warning

WARNING

FOR SAFETY REASONS THIS EQUIPMENT MUST BE OPERATED BY QUALIFIED PERSONNEL ONLY.
READ AND UNDERSTAND THE INSTRUCTION MANUAL COMPLETELY BEFORE OPERATING OR
SERVICING THE EQUIPMENT.

12 Technical Data MGC2

Electrical	
Power supply	24 V DC \pm 20 %, reverse-polarity protected 24 V AC \pm 15 %
Overvoltage category	I
Power consumption (24 V DC)	
- Control Board	Max. 60 mA (1.5 VA), without sensor
- per sensor (analog)	Max. 85 mA (2.1 VA)
- horn / warning light	Max. 40 mA (1.0 VA)
Overvoltage category	I
Alarm relays (3)	240 V AC, 5 A, potential-free, change-over contact (SPDT)
Transistor output (2)	24 V DC / 0.1 A (switching to plus) (only at 24 V DC power supply)
Digital input (2)	Potential-free
Analog input (3)	4 – 20 mA overload and short-circuit proof, input resistance 200 Ω
Analog output signal (1)	Proportional, overload and short-circuit proof, load \leq 500 Ohm 4 - 20 mA = measuring range 3.0 < 4 mA = underrange > 20 - 21.2 mA = overrange 2.0 mA = fault (not preset)
Ambient conditions	
Temperature range	-25 °C to +50 °C (-13 °F to +122 °F)
Humidity range	15 - 95 % RH not-condensing
Storage temperature	+5 °C to +40 °C (+41 °F to +104 °F)
Serial interface	
Field bus	RS 485 / 19200 Baud
Tool bus	2-wire / 19200 Baud
Physical	
Housing type C	Polycarbonate
Combustion	UL 94 V2
Housing colour	RAL 7032 (light grey)
Dimension housing (W x H x D) Type C	130 x 130 x 75 mm (5.12 x 5.12 x 2.95 in.)
Weight	ca. 0.6 kg (1.32 lb.)
Protection class (delivery status*)	NEMA 4X (IP 65)
Installation	Wall mounting
Knockouts for cable and sensor entry	Standard 6 x M20/25
Wire connection:	
Digital input, analog output	Screw-type terminal min. 0.25 mm ² , max. 1.3 mm ² (24 to 16 AWG)
Power supply, relays	Screw-type terminal min. 0.25 mm ² , max. 2.5 mm ² (24 to 10 AWG)
Directives	EMC directives 2014/30/EU Low voltage directive 2014/35/EU CE EN 61010-1:2010
Warranty	1 year on device

*If there are changes on the housing it has to be re-evaluated

LCD Display	
LCD	Two lines, 16 characters each, background highlighted in two colours
Operation	Menu driven via six pushbuttons
Power consumption	5 V, 60 mA, 0.3 VA



13 EC – Declaration of Conformity

PERFECT SOLUTIONS IN GAS ALARM SYSTEMS

www.msr-electronic.de



EG - Konformitätserklärung EC - Declaration of Conformity

Wir erklären in alleiniger Verantwortung, dass die bezeichneten Produkte mit den folgenden Normen und Richtlinien übereinstimmen.

We declare under our sole responsibility that the products to which this declaration relates are in conformity with the following standards and directives.

Dokument-Nr. / Document-No. CE_MSC2 & MGC2_0416
Hersteller / Manufacturer: MSR - Electronic - GmbH
Würdinger Str. 27
D-94060 Pocking
Produktbezeichnung / Name: PolyGard®2 Multi Sensor Controller Series MSC2 & MGC2
Richtlinie / Directive: 2014 / 30 / EU
Elektromagnetische Verträglichkeit. / Electromagnetic compatibility
2014 / 35 / EU
Niederspannungsrichtlinie / Low voltage Directive

Norm / Standard: EN 61010-1-2010+Cor. 2011
Sicherheitsbestimmungen für elektrische Mess-, Steuer-, Regel-, und Laborgeräte.

Norm / Standard: EN 50 271 (IEC-61508)
Elektrische Geräte für die Detektion und Messung von brennbaren Gasen, giftigen Gasen oder Sauerstoff - Anforderungen und Prüfungen für Warngeräte, die Software und/oder Digitaltechnik nutzen; Deutsche Fassung EN50271:2010

Für die funktionale Sicherheit entspricht der komplette Entwicklungsprozess für Hard- und Software Sicherheitslevel SIL2, Low Demand.

Electrical apparatus for the detection and measurement of combustible gases, toxic gases or oxygen - Requirements and tests for apparatus using software and/or digital technologies; German version EN50271:2010

Full Development process for hard- and software is designed according safety requirement SIL2 –low demand

Aussteller/ Issued by: MSR - Electronic - GmbH
Datum / Date: Pocking, 19.04.16

Rechtsverbindliche Unterschrift/ binding signature:

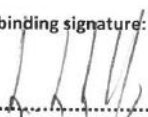
.....
Dipl.-Ing. Wolfgang Schmitt

Diese Erklärung bescheinigt die Übereinstimmung mit den genannten Richtlinien, beinhaltet jedoch keine Zusicherung von Eigenschaften. Die Sicherheitshinweise der mitgelieferten Produktdokumentation sind zu beachten.
This declaration certifies the conformity to the mentioned directives. It does not confirm any attributes. The security hints of the specific instruction manuals have to be followed



MSR-Electronic GmbH ::: Würdinger Str. 27 & 27A ::: 94060 Pocking ::: Germany
Technische Änderungen vorbehalten
PolyGard® ist ein eingetragenes Warenzeichen von MSR-Electronic GmbH



14 Part Disposal

Since August 2005 there are European-wide directives defined in the European Directive 2002/96/EC and in national codes concerning the waste electrical and electronic equipment and regarding this device.

For private households, there are special collecting and recycling possibilities. For this device isn't registered for the use in private households, it mustn't be disposed this way. You can send it back to your national sales organisation for disposal. If there are any questions concerning disposal, please contact your national sales organisation.

Outside the Europe, you have to consider the corresponding directives.

15 Notes and General Information

It is important to read this user manual thoroughly and clearly in order to understand the information and instructions. The PolyGard®2 devices must be used within product specification capabilities. The appropriate operating and maintenance instructions and recommendations must be followed.

Due to on-going product development, MSR-Electronic GmbH reserves the right to change specifications without notice. The information contained herein is based upon data considered to be accurate. However, no guarantee is expressed or implied regarding the accuracy of these data.

15.1 Installers' Responsibilities

It is the installer's responsibility to ensure that all PolyGard®2 devices are installed in compliance with all national and local codes and OSHA requirements. Installation should be implemented only by technicians familiar with proper installation techniques and with codes, standards and proper safety procedures for control installations and the latest edition of the National Electrical Code (ANSI/NFPA70).

The equipotential bonding required (also e.g. secondary potential to earth) or grounding measures must be carried out in accordance with the respective project requirements. It is important to ensure that no ground loops are formed to avoid unwanted interference in the electronic measuring equipment.

It is also essential to follow strictly all instructions as provided in the user manual.

15.2 Disclaimer

In no event shall Honeywell be liable for any damages or injury of any nature or kind, no matter how caused, that arise from the use of the equipment referred to in this manual.

Strict compliance with the safety procedures set out and referred to in this manual, and extreme care in the use of the equipment, are essential to avoid or minimise the chance of personal injury or damage to the equipment.

The information, figures, illustrations, tables, specifications, and schematics contained in this manual are believed to be correct and accurate as at the date of publication or revision. However, no representation or warranty with respect to such correctness or accuracy is given or implied and Honeywell will not, under any circumstances, be liable to any person or corporation for any loss or damages incurred in connection with the use of this manual.

The information, figures, illustrations, tables, specifications, and schematics contained in this manual are subject to change without notice.

Unauthorised modifications to the gas detection system or its installation are not permitted, as these may give rise to unacceptable health and safety hazards.

By installing this equipment on a computer network, the owner accepts full and unequivocal responsibility for ensuring that it is protected against all cyber threats and illegal tampering during the lifetime of the equipment.

Any software forming part of this equipment should be used only for the purposes for which Honeywell supplied it. The user shall undertake no changes, modifications, conversions, translations into another computer language, or copies (except for a necessary backup copy).

In no event shall Honeywell be liable for any equipment malfunction or damages whatsoever, including (without limitation) incidental, direct, indirect, special, and consequential damages, damages for loss of business profits, business interruption, loss of business information, or other pecuniary loss, resulting from any violation of the above prohibitions.



15.3 Warranty

Honeywell Analytics warrants the PolyGard®2 Multi-Gas Controller against defective parts and workmanship, and will repair or (at its discretion) replace any components that are or may become defective under proper usage within 12 months from the date of commissioning by a Honeywell Analytics approved representative* or 12 months from shipment from Honeywell Analytics, whichever is sooner.

This warranty does not cover consumables, batteries, fuses, normal wear and tear, or damage caused by accident, abuse, improper installation, unauthorized use, modification or repair, ambient environment, poisons, contaminants or abnormal operating conditions.

This warranty does not apply to sensors or components that are covered under separate warranties, or to any 3rd-party cables and components.

Any claim under the Honeywell Analytics Product Warranty must be made within the warranty period and as soon as reasonably practicable after a defect is discovered. Please contact your local Honeywell Analytics Service representative to register your claim.

This is a summary. For full warranty terms please refer to the Honeywell Analytics' General Statement of Limited Product Warranty, which is available on request.

* A Honeywell Analytics approved representative is a qualified person trained or employed by Honeywell Analytics, or a qualified person trained in accordance with this manual.

15.4 Copyright Notice

Microsoft, MS and Windows are registered trademarks of Microsoft Corp.

Other brand and product names mentioned in this manual may be trademarks or registered trademarks of their respective companies and are the sole property of their respective holders.

Honeywell is the registered trademark of Honeywell Automation and Control Systems (ACS).

Find out more at www.honeywellanalytics.com