

# COMMISSIONING, OPERATING AND MAINTENANCE MANUAL

# MX 52

## MEASURING UNIT

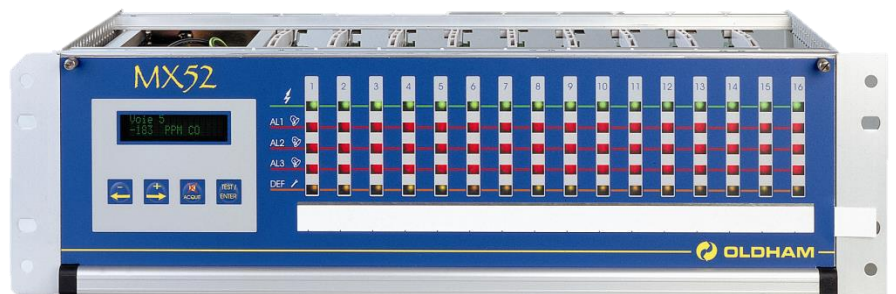

Part Number: NP52UGB  
Revision: B.0

**OLDHAM**  
The Fixed Gas Detection Experts

Copyright © April 2016 by Oldham S.A.S.

All rights reserved. The reproduction of all or any section of this document in any form whatsoever without the written permission of Oldham S.A.S. is forbidden.

The information contained in this manual is accurate to our knowledge.

As a result of continuous research and development, the specifications of this product may be modified at any time without prior notice.

# GAS DETECTION

We are delighted that you have chosen an **OLDHAM** instrument and would like to thank you for your choice.

We have taken all the necessary measures to ensure that your instrument provides total satisfaction.

Now it is important to read this document carefully.

## EXTENT OF RESPONSIBILITY

- \* **OLDHAM** declines its responsibility towards any person for material damage, physical injury or death resulting wholly or partly from inappropriate use, installation or storage of its equipment resulting from failure to observe instructions and warnings and/or standards and regulations in force.
- \* **OLDHAM** neither supports nor authorises any company, physical or moral person to assume responsibility on behalf of **OLDHAM** , even if it is involved in the sale of **OLDHAM** products.
- \* **OLDHAM** cannot be held responsible for direct or indirect damage or be required to pay direct or indirect compensation resulting from the sale or use of any of its products **IF THESE PRODUCTS HAVE NOT BEEN DEFINED AND CHOSEN BY OLDHAM FOR THEIR SPECIFIC USE.**

## CLAUSES CONCERNING PROPERTY

- \* Drawings, plans, specifications and information included in this document contain confidential information that is the property of **OLDHAM**
- \* None of this information may be reproduced, copied, divulged or translated, by physical, electronic or any other means, nor used as the basis for the manufacture or sale of **OLDHAM** equipment or for any other reasons **without prior consent from OLDHAM**

## WARNINGS

- \* This document is not contractually binding. In the interests of its customers, **OLDHAM** reserves to modify the technical specifications of its equipment without notice, in order to improve its performance.
- \* **READ THIS MANUAL CAREFULLY BEFORE FIRST USE OF THE EQUIPMENT:** this manual must be read by any person who is or will be responsible for using, maintaining or repairing this equipment.
- \* **This equipment will only provide the announced performance levels if it is used, maintained and repaired according to OLDHAM directives, by OLDHAM personnel or by personnel approved by OLDHAM**

## GUARANTEE

2 years guarantee in normal conditions of use on parts and technical labour, return in our workshops, excluding consumables (sensors, filters, etc.)



# CONTENTS

<b>1. DESCRIPTION.....</b>	<b>7</b>
1.1. <i>General.....</i>	7
1.2. <i>Rack.....</i>	8
1.3. <i>The various printed circuit boards.....</i>	8
<b>2. INSTALLATION AND CONNECTIONS.....</b>	<b>9</b>
.1. <i>Installation: recommendations .....</i>	9
.2. <i>Electrical connections of the MX52 Unit (Fig. 8).....</i>	9
2.2.1. <i>Alternative power supply .....</i>	9
2.2.2. <i>DC power supply .....</i>	10
.3. <i>Detectors (Figures 9 and 12).....</i>	10
2.3.1. <i>Explosimetric detectors of PONT type .....</i>	10
2.3.2. <i>3-wire detectors 4-20 mA: 3 connecting wires for shielded cable.....</i>	11
2.3.3. <i>2-wire detectors 4-20 mA: 2 connecting wires for shielded cable.....</i>	11
2.3.4. <i>FIRE detectors: 2 connecting wires for shielded cable.....</i>	11
2.3.5. <i>FLAME detectors: 2, 3 or 4 connecting wires for shielded cable depending on utilization .....</i>	11
2.3.6. <i>CO2 detector of type “Ventostat VT” .....</i>	13
2.3.7. <i>Specific case of intrinsic safety detectors .....</i>	13
2.3.8. <i>Other detectors with standardized current output .....</i>	14
2.3.9. <i>Parking application .....</i>	14
.4. <i>Connecting the unit to external devices .....</i>	15
2.4.1. <i>Slaving controls.....</i>	15
2.4.2. <i>4-20 mA current outputs (Fig. 12) .....</i>	16
2.4.3. <i>RS 232 and RS 485 outputs .....</i>	16
2.4.4. <i>Remote acknowledgement .....</i>	18
<b>3. STARTING UP.....</b>	<b>19</b>
3.1. <i>Checking the installation .....</i>	19
3.2. <i>Switching on the unit.....</i>	19
3.3. <i>Operating modes .....</i>	20
3.3.1. <i>Audio warning device (buzzer).....</i>	20
3.3.2. <i>Light-emitting diodes (LED) (Fig. 26) .....</i>	20
3.3.3. <i>Alarm thresholds .....</i>	20
3.3.4. <i>Fault thresholds .....</i>	25
3.3.5. <i>Measuring unit .....</i>	26

<b>4.</b>	<b>UTILIZATION .....</b>	<b>27</b>
4.1.	<i>List and functions of the various items of “USER” equipment for programming and calibration of the unit.....</i>	27
4.1.1.	Keypad (see Figures 26 and 4).....	27
4.1.2.	Maintenance keys.....	28
4.1.3.	Potentiometers.....	28
4.2.	<i>Menus .....</i>	29
4.2.1.	The various menus and their functions .....	29
4.2.2.	Block diagram of the scrolling of the various menus .....	29
4.2.3.	Detailed flow diagrams of each menu.....	31
<b>5.</b>	<b>SETTING THE MX52 UNIT INTO SERVICE .....</b>	<b>45</b>
5.1.	<i>Programming the unit .....</i>	45
5.2.	<i>Programming the measuring channels .....</i>	45
5.2.1.	Programming.....	45
5.2.2.	Copy .....	46
5.3.	<i>Calibrations .....</i>	46
5.4.	<i>4-20 mA output adjustment for a measurement channel.....</i>	50
<b>6.</b>	<b>MAINTENANCE.....</b>	<b>51</b>
6.1.	<i>Periodic / preventive maintenance .....</i>	51
6.1.1.	On the MX52 unit .....	51
6.1.2.	On the detectors .....	51
6.2.	<i>Failures: causes and remedies .....</i>	52
6.3.	<i>Scrapping of MX52 .....</i>	55
6.4.	<i>List of spare and replacement parts.....</i>	55
<b>7.</b>	<b>VIEWS SPECIFIED IN THE MANUAL .....</b>	<b>57</b>
<b>8.</b>	<b>DETAILED TECHNICAL CHARACTERISTICS .....</b>	<b>87</b>
<b>9.</b>	<b>Special Specifications for use in Potentially Explosive Atmospheres in accordance with European Directive ATEX 94/9/EC. ....</b>	<b>89</b>

# 1. DESCRIPTION

---

## 1.1. General

---

The MX52 measuring and alarm unit can be fitted with between one and 16 independent channels.

Each channel is connected to one or more detectors installed in the locations to be monitored.

The measurement that is output from the detector is displayed on the MX52 unit and compared with alarm thresholds. If thresholds are exceeded, the unit actuates relays which can be used to control external devices.

### REMARK

The equipment of the MX52 unit comprises line PCBs, each equipped with two channels. However, each channel is independent and can be connected to any type of OLDHAM detector provided that the PCB is suitably programmed. The number of line PCBs is always equal to the mixed even number greater than the number of channels used divided by two.

## MAIN CHARACTERISTICS

- Rack 3U 19"
- AC or DC power supply
- 16 measuring inputs for detectors
- Display of measurement on a plasma display panel (2 lines - 16 characters)
- One keypad with four keys for the user
- One "CALIBRATION" key and one "PROGRAMMING" key for maintenance (accessible only by opening the front panel)
- **3 gas alarms per channel**
  - Two instantaneous rising or falling thresholds, manual or automatic clearing, with "extractor control logic (tunnel parking application)"
  - One rising or falling threshold, automatic clearing, triggering by time delay or average

### Relaying

Total of 34 relays distributed as follows:

- Two relays per channel, with positive or negative safety, contacts open or closed at rest for the first two thresholds

- One relay common to channels for third thresholds or for all alarms (buzzer transmission), with positive or negative safety, contacts opened or closed at rest
  - One relay common to channels for faults and failures, constant positive safety mode, contacts open or closed at rest.
- 
- Current output (4-20 mA) per measuring channel.
  - Common audio alarm that can be acknowledged in the case of occurrence of gas alarms.

## ***1.2. Rack***

---

The MX52 rack is of the 3U 19" type.

- Overall dimensions: Fig. 1
- Overall view, front profile: Fig. 2
- Overall view, back profile: Fig. 3

## ***1.3. The various printed circuit boards***

---

- Overall view: Fig. 4
- Power board and module: Fig. 5
- MICRO board: Fig. 6
- Measuring channel board: Fig. 7
- Front connection board: Fig. 4



## 2. INSTALLATION AND CONNECTIONS

---

Please ensure you read the paragraph: Special Specifications for use in Potentially Explosive Atmospheres in Accordance with European Directive ATEX 94/9/EC

### **.1. *Installation: recommendations***

---

The MX52 unit can be installed in any premises without an explosive atmosphere. They should preferably be placed in a ventilated and monitored location (guardhouse, control room, instrumentation room, etc.).

Attachment is to be ensured in accordance with the dimensions in Figure 1 (four attachment points).

#### **REMARK**

In order to permit the swivelling front panel of the unit to be opened completely, allowance must be made for opening by rotation through 180° downwards.

Before making any connections, the unit should be switched off using the main On/Off switch below and to the left of the FRONT circuit (see Figures 4 and 26).

### **.2. *Electrical connections of the MX52 Unit (Fig. 8)***

---

The MX52 unit is equipped with a pulse automatic device which enables to connect 24 V DC voltage in a lack of 220 V AC voltage so we can use no expansive save power supply.

#### **2.2.1. *Alternative power supply***

- Voltage: 230 V AC (207 to 244 V) 50/60 Hz
- Maximum power: 300 VA
- Maximum current in cable: 1.5 A
- Cable: 3 x 1.5 mm<sup>2</sup> (including earth)
- Location of connection terminal blocks: Fig. 8, item A
- Protection: the phase and neutral wires are protected by time-delayed 2 A fuses located at the rear of the power module.
- Voltage: 103 to 122 V AC - 50/60 Hz on option

#### **CAUTION**

It is mandatory that the appliance must be earthed. A terminal is reserved for this purpose at the back of the power module: see Fig. 5. This connection is required in order to ensure correct operation of the following:

- mains power interference filter,
- protective devices against electromagnetic interference.

### 2.2.2. *DC power supply*

- Voltage: 21 to 30 V continue. The "-" from continue power supply is linked to earth (and earth being linked to frame).
- Maximum power: 240 W
- Maximum current in cable: 12.5 A
- Cable: 2 x 2.5 mm<sup>2</sup> or 2 x 4 mm<sup>2</sup> depending on length
- Location of terminal block: see Fig. 8, item D
- Protection: by two fuses located at the back of the power module (Fig. 8, item E)

## .3. *Detectors (Figures 9 and 12)*

---

### REMARK

- The detectors are linked by SHIELDED cables.
- The utilization of shielded cables is MANDATORY
- The earth braid of shielded cables must be connected to the earth at one end only.

### CAUTION

**Each channel is configured in the factory for a given type of detector (explosive gas, toxic gas, fire or flame). If two different types of detector are interchanged, this may result in the destruction of the central unit or of the detector.**

### 2.3.1. *Explosimetric detectors of PONT type*

Three connecting wires for a shielded cable.

Resistance of detector / unit cable: 16 ohms maximum per wire, i.e. 32 ohms in loop (1 km for cable 3 x 1.5 mm<sup>2</sup>).

Connection on MX52 unit: see Fig. 10

### **2.3.2. 3-wire detectors 4-20 mA: 3 connecting wires for shielded cable**

- Resistance of detector / unit cable: 16 ohms maximum per wire, i.e. 32 ohms in loop (1 km for cable 3 x 1.5 mm<sup>2</sup>).
- Connection on MX52 unit: see Fig. 10.

### **2.3.3. 2-wire detectors 4-20 mA: 2 connecting wires for shielded cable**

- Resistance of detector / unit cable: 32 ohms maximum per wire, i.e. 64 ohms in loop (2 km for cable 2 x 1.5 mm<sup>2</sup>).
- Connection on MX52 unit: see Fig. 11.

### **2.3.4. FIRE detectors: 2 connecting wires for shielded cable**

The current commercial designations are as follows:

- “Thermovelo” detectors of type EC 11 (sensitive to temperature variations)
- Ionic detectors of type EI 1 100 (sensitive to smoke)
- Optical detectors of type EO 1 100 (sensitive to smoke)
- Resistance of detector / unit cable: 28 ohms maximum per wire, i.e. 56 ohms in loop (2 km for cable 2 x 1.5 mm<sup>2</sup>)
- Fire detectors can be detected in parallel to a maximum of five. The end-of-loop resistor (2.7 K) is to be placed at the end of the line on the last detector.
- Connection on MX52 unit: see Fig. 11.

### **2.3.5. FLAME detectors: 2, 3 or 4 connecting wires for shielded cable depending on utilization**

#### **REMARK**

The detectors can be supplied with power either via the MX52 unit or by an auxiliary 24 V DC source.

These detectors can operate in standalone mode:

24 V DC power supply and direct utilization of relay contacts in accordance with the technical specification corresponding to the detector used.

The current commercial designations are as follows:

- model 20/20 U - analog - type UV - 752002 (sensitive to UV radiation)
- model 20/20 UC - analog - type UV (sensitive to UV radiation)
- model 20/20 UB -  $\mu$ P technology - type UV - 772002 (sensitive to UV radiation)
- model 20/20 UBC -  $\mu$ P technology - type UV (sensitive to UV radiation)
- model 20/20 LC - analog - type UV/IR (pyroelectric, combination of UV and IR detectors)
- model 20/20 LBC -  $\mu$ P technology - type UV/IR (pyroelectric, combination of UV and IR detectors)
- model 20/20 I -  $\mu$ P technology - triple IR detector - 780002 (pyroelectric, sensitive to IR radiation)

These detectors are equipped with various types of terminal block (see table below).

<b>Model</b>	20/20 U	20/20 UC	20/20 UB	20/20 LC	20/20 UNC	20/20 LBC	20/20 I
<b>Type of terminal block</b>	B	C	A	C	C	C	A

- Resistance of cable / unit
  - In the case of local 24 V DC power supply:  
8.5 ohms maximum per wire, i.e. 17 ohms in loop
  - In the case of power supply via the MX52 unit:  
3 ohms maximum per wire, i.e. 6 ohms \* in loop

\* 4 ohms for detector 20/20 I (IR3)

- Connection on MX52 unit (ONE detector per measuring channel ONLY):
  - detector equipped with a terminal block of type A: see Fig. 13
  - detector equipped with a terminal block of type B: see Fig. 14
  - detector equipped with a terminal block of type C: see Fig. 15

Example of the utilization of the 4-20 mA signal from flame detectors equipped with connectors of type A or C: see Fig. 16.

Example of the utilization of detectors equipped with connectors of either type A or type B and with auxiliary power supply. The auxiliary power supply must be able to supply power to the number of detectors planned in the measuring loop (see Fig. 17).

## REMARK

In the case of this application, the maximum of five flame detectors can be connected in the measuring loop.

Example of the utilization of IR3 or UV/IR detectors equipped with connectors of type A with a local junction box and galvanic insulation (see Fig. 18).

### 2.3.6. *CO2 detector of type "Ventostat VT"*

- Connection on MX52 unit: see Fig. 20.
- Resistance of detector/unit power cable: 12 ohms maximum per wire, i.e. 24 ohms in loop.
- 4-20 mA output: maximum load = 280 ohms (whole loop)

### 2.3.7. *Specific case of intrinsic safety detectors*

Two types of intrinsic safety barrier can be used: Z787 / EX and MTL787S+.

## PRECAUTIONS

Before connecting the barrier to the unit, check that the voltage is < 25 V DC.

- A short circuit in the electrical connections will result in destruction of the barrier.
- Perform wiring in the DE-ENERGIZED state.
- The electrical link between the MX52 unit and the clipper is made using a screened cable with two active conductors with a maximum resistance of 12 ohms each.

## REMARK

**In classified areas, the installation must comply with the standards in force.**

- Connections on MX52 unit: see Fig. 21.

## IMPORTANT

**All intrinsic safety installations must be APPROVED as a whole assembly by an approved organization (DRIRE, etc.).**

---



---

**OLDHAM “INTRINSIC SAFETY” BARRIERS**

---



---

<b>Type of IS barrier</b>	<b>Reference</b>	<b>Specific features</b>	<b>OLDHAM box reference</b>	
Z787 / EX	6184703	To be fitted on DIN RAIL		
MTL787S+	6797100	To be fitted in an approved box: MANDATORY	For 2 clippers	6797192
			For 5 clippers	6797547
			For 12 clippers	6797101

**2.3.8. Other detectors with standardized current output**

Any detector (with 2 wires or 3 wires) that can be supplied with power between 19 V DC and 32 V DC and that supplies a standardized current (signal) of between 4 and 20 mA can be connected to the MX52 unit.

The connection requirements are identical to those for the corresponding OLDHAM detectors (see Fig. 22).

**2.3.9. Parking application**

CTX300 "Co parking" toxic gas detectors can be fitted in parallel when a mean gas concentration is to be obtained. The detectors must, imperatively, be located in the same area. In this case, a maximum of five detectors can be connected (see Fig. 23).

## **.4. *Connecting the unit to external devices***

---

### **2.4.1. *Slaving controls***

The 16 measuring channels of the MX52 unit are each equipped with two relays which can be used to control external devices: sirens, solenoid valves, extractors, telephone calls, etc..

For each measuring channel, the relays are distributed in the following manner (see Fig. 7):

- a relay associated with the triggering of alarm 1,
- a relay associated with the triggering of alarm 2,
- use of open or closed contacts selected with a jumper (see Fig. 7),
- use of positive or negative safety selected by programming (see the CHANNEL programming menu),
- contact outputs on the back of the measuring board (see Fig. 12).
  
- An example of connection is given in Fig. 24:
  - a siren connected to relay AL1 will be actuated as soon as alarm 1 is triggered,
  - a solenoid valve connected to relay AL2 will be actuated as soon as alarm 2 is triggered.

#### **For all channels:**

- A common relay associated with the triggering of alarm 3 for the 16 channels.

By programming, this common relay can also be used for the remote transmission of the audio warning signal. (This relay will then be associated with all the unit's alarms). The 3 contacts are available back to power supply module (fig 8).

- A **fault** relay associated with the triggering of channel faults (detector failures, electrical connections, excessively negative zero, etc.). This relay will always be in positive safety mode (see Fig. 5). The use of open or closed contacts is selected by programming on common board.
  
- Common relay contact outputs on the back of the power module: Fig. 8.

#### **REMARK**

Owing to the breaking capacity of the MX52 unit's relays which is limited to 2 A / 250 V AC or 30 V DC, external intermediate relays must be used if the devices to be controlled require high power levels.

### 2.4.2. 4-20 mA current outputs (Fig. 12)

For each measuring channel, the MX52 unit is equipped with a 4-20 mA output that can be used to retransmit measurements to a recorder or an external PLC. The maximum resistance in loop mode is 600 ohms. The earth connections for the 4-20 mA outputs are common and the unit. The 4-20 mA lines are not galvanically insulated one from the other. The current output varies according to the measurement and has several states, as follows:

- On starting up the unit:  $I < 1$  mA
- With FAULT:  $I < 1$  mA
- In MAINTENANCE mode:  $I = 2$  mA
- ZERO MEASUREMENT:  $I = 4$  mA
- Full scale:  $I = 20$  mA
- Out of range or "in doubt":  $I > 23.2$  mA

An example of the connection of a multi-channel recorder is given in Fig. 25.

### 2.4.3. RS 232 and RS 485 outputs

#### RS232 OUTPUT

A computer can be connected on a female sub.D/DB9 type connector located on the back of the micro board (fig6 repA). The MX52 programming, from outside, will be possible thanks to this connection.

#### RS 232 OUTPUT USING

- Remove the DB9 connector (pmug with an internal strap)
- Connect a link cable ref.6315831 which will link the monitor to the computer on the MX52 available female connector DB9 (repA Fig6)

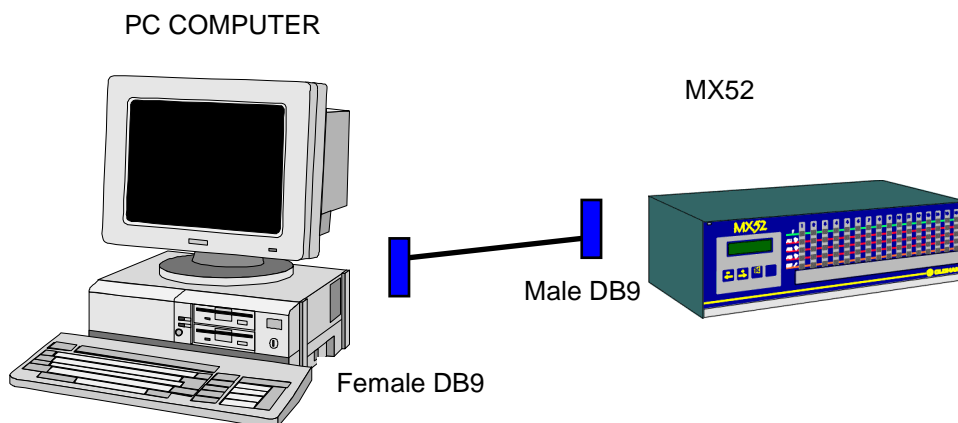

- when the using is stopped : no connect the cable and put the male DB9 "plug" again.



## **RS 485 OUTPUT (PINABLE ON FIG 29)**

Several MX52 units can be linked to a single computer, which is the "master" of the network. In this case, a "SLAVE NUMBER" (by programming/unit) is assigned to each MX52 unit.

This RS 485 output can be galvanically insulated as an option.

### **1<sup>st</sup> case : no galvanic insulation**

- no mounted insulation component
- 2 polarization electrical resistances are programmed and welded

### **2<sup>nd</sup> case : with galvanic insulation**

- mounted and welded insulation component
- no programmed polarization electrical resistance for "plu" (+ 5V)
  - a) with RS 485 shielded
    - no programmed polarization resistor for "moins" (GND)
  - b) without RS485 shielded
    - programmed polarization resistor for "moins" (GND)

### **End loop resistor**

It is located on the MX52 micro board and must be programmed with the last MX52 unit of the loop (by pins) with a 120 Ohms value.

The MX stored data are some instantaneous values

The RS485 output is a half duplex type.

## **RS 485 OUTPUT USING**

- No change the sub D/DB9 "plug" connector
- Connect the screwed connector terminals 3,4 and 5, located on the back of the MX52 unit (repB Fig6). See connection details fig 29.
- Owing to mounted wires or not (following the mounting and the equipment linked or not on the earth...).

## **IMPORTANT**

**All details regarding the RS 485 complete description (Modbus / Jbus format, structures, addresses aso...) are developed in a leaflet ref. D 813 577.**

### **CAUTION**

A computer must be used in order to printout the data stored by the MX52 unit.

- Several MX52 units can be connected to a single computer which is the "MASTER". In this case, a SLAVE number is assigned to each MX52 unit.

#### ***2.4.4. Remote acknowledgement***

It is possible to allow remote acknowledgement by connecting on connector 5 plugs, on the back of the micro board : see fig 6 item B.

## 3. STARTING UP

---

### 3.1. *Checking the installation*

---

It is checked that, at least, all connections have been made and that the complete installation complies with current standards in force.

**CAUTION**  
**OLDHAM is not responsible for the compliance of the complete electrical safety system.**

The MX52 unit is switched on by means of circuit breakers \* provided for that purpose and which ensure protection of the mains power unit.

\* The circuit breakers are to be selected according to the power consumption levels specified by the manufacturer and the length of the electric cables.

### 3.2. *Switching on the unit*

---

**CAUTION**  
**The handling operations and adjustments described in these paragraphs are strictly reserved for authorized personnel as they are liable to affect detection safety.**

To start up the MX52 unit, you must:

- swivel the front panel,
- press the ON/OFF button located to the bottom left-hand side of the FRONT circuit: see Figures 4 and 26 (item A).
- The display panel then shows, for example:

**MX 52 V2.0**

The unit then goes into INITIALIZATION mode for one minute. Consequently, all the alarms are inhibited and the current outputs are 1 mA for the channels in service. The unit then performs a self-test \* on its buzzer and all its night-emitting diodes. At the end of this one-minute period, the channels in service return to normal operation and the corresponding alarms and relays are enabled.

\* The user can carry out a “manual-self test” by pressing the test key at any time (see Fig. 26). This self-test lasts 20 seconds and the display panel may show the following displays one after the other, for example:

MX 52 v2.ϕ  
xx LEL CH4

Line corresponding to the channel displayed when the ENTER key was pressed

then

\*\*\* SELF-TEST \*\*\*  
xx LEL CH4

The user can interrupt the self-test cycle before it is completed by pressing the ACKNOWLEDGEMENT key.

### 3.3. Operating modes

---

#### 3.3.1. Audio warning device (buzzer)

In normal operation, the audio warning device is triggered whenever a fault or an alarm appears. The audio warning device can be stopped by pressing the ACKNOWLEDGEMENT key or by remote acknowledgement. The buzzer makes a continuous or discontinuous sound (according to the programming of the unit) if an alarm threshold is exceeded.

#### 3.3.2. Light-emitting diodes (LED) (Fig. 26)

Each channel is equipped with five LEDs (visible and identified on the FRONT panel).

LED	Extinguished	Illuminated in steady mode	Flashing
GREEN	Channel not in service	Channel in service	Threshold AL1 exceeded (manual clearing) and not acknowledged
1st red	AL1 not triggered	Threshold AL1 exceeded (automatic clearing)	Threshold AL2 exceeded (manual clearing) and not acknowledged
2nd red	AL2 not triggered	Threshold AL2 exceeded (automatic clearing)	
3rd red	AL3 not triggered	Threshold AL3 exceeded by mean or time (automatic clearing)	
Yellow	No fault	Fault on channel	-Channel being calibrated or programmed - Detector being calibrated

#### 3.3.3. Alarm thresholds

Each of the three alarm thresholds can be programmed independently for each channel. (See the “Channel programming” menu).

In normal operation, a gas alarm is only triggered after a preprogrammed time delay in order to avoid spurious alarms.

Alarm thresholds can be processed in the following manners:

- in normal cycle with manual clearing: block diagram 1,
- in normal cycle with automatic clearing: block diagram 2,
- in parking cycle: block diagram 3.

The alarm thresholds are to be selected according to the gases detected and the corresponding standards in force.

**Special case:** A channel connected to a fire detector

- It is MANDATORY to select the scale with 100 divisions.
- It is MANDATORY to select the alarm threshold with 60 divisions.

(Owing to the end-of-loop resistor of 2.7 k $\Omega$ , the fire detector outputs 4 mA when no fire is detected and 20 mA if a fire is detected).

**BLOCK DIAGRAM 1  
NORMAL CYCLE WITH MANUAL CLEARING**

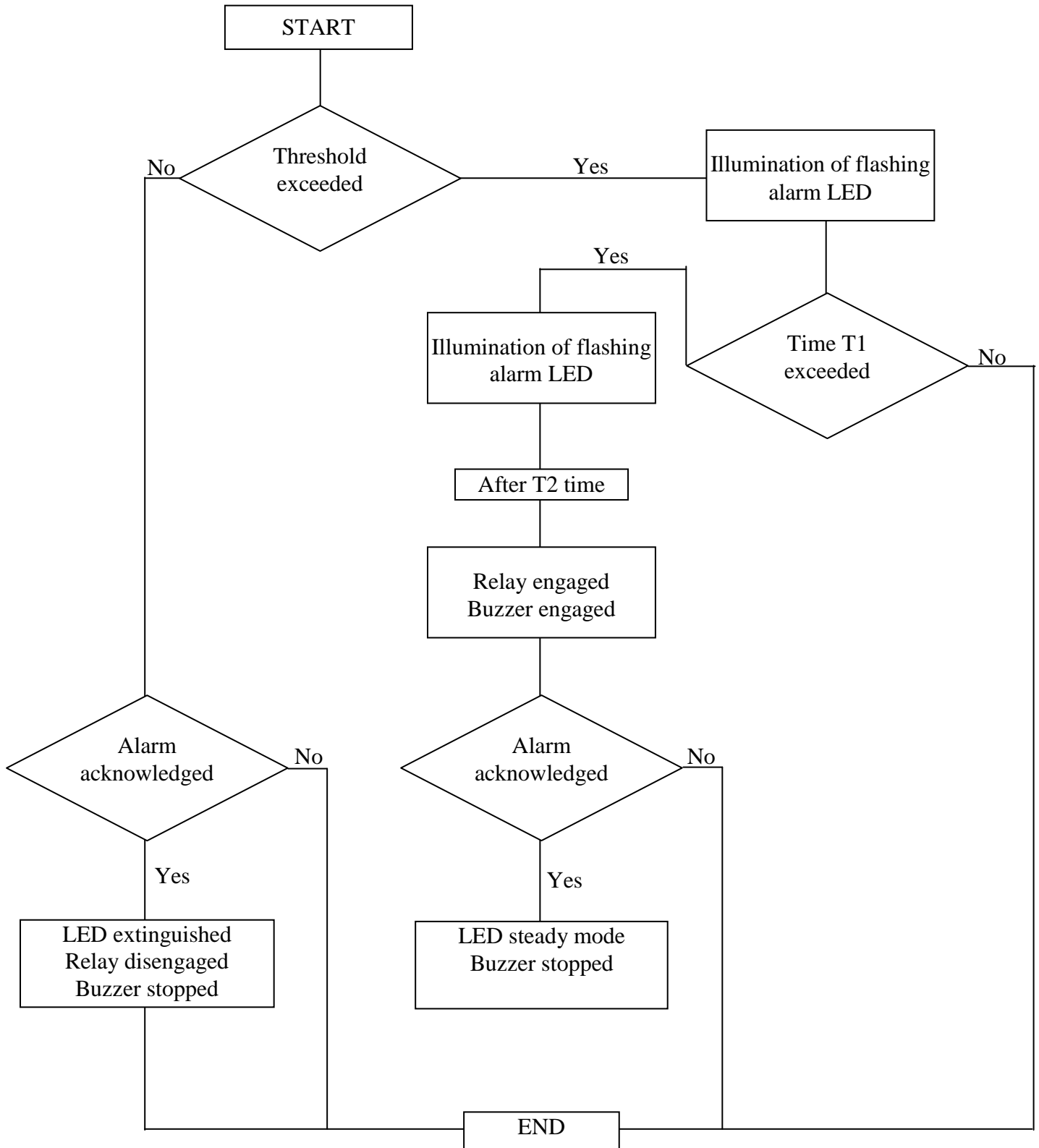

**BLOCK DIAGRAM 2**  
**NORMAL CYCLE WITH AUTOMATIC CLEARING**

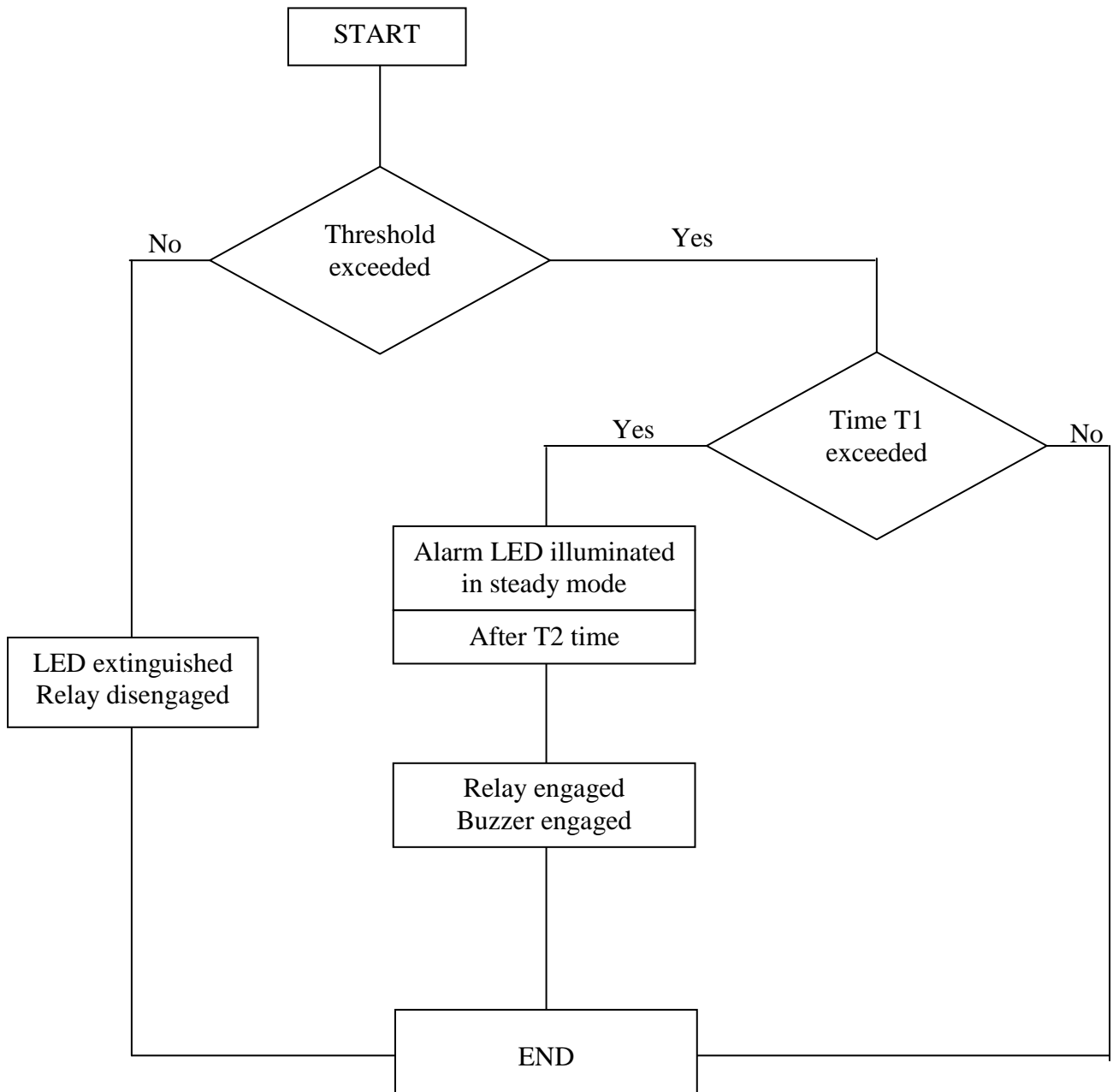

## BLOCK DIAGRAM 3 PARKING CYCLE

Alarm 3 operates in the same way as the normal cycle.

The times defined for alarms 1 and 2 (time delays) are, in this case, used to define the minimum operating time for each relay.

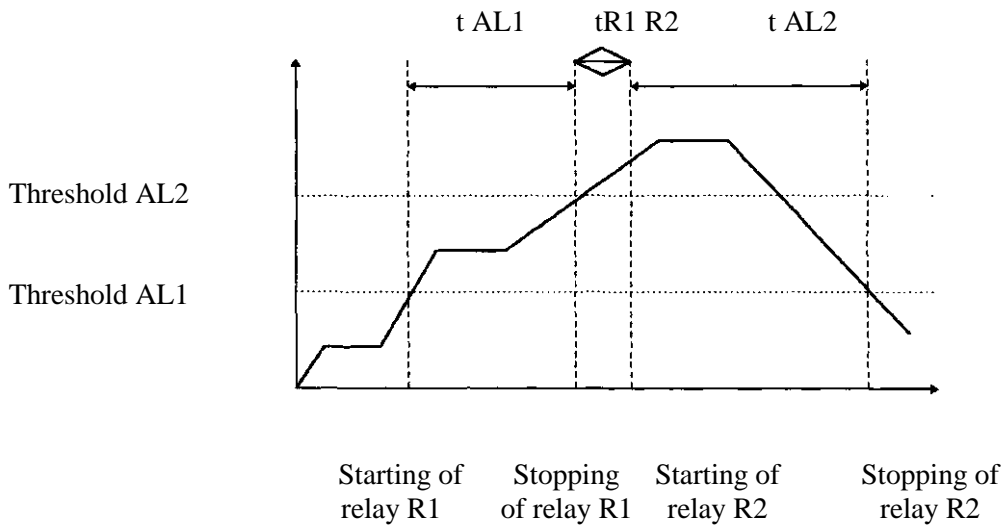

		<b>min.</b>
$t_{AL1}$	Min. operating time for alarm 1 (defined for each channel)	$t_1$
$t_{AL2}$	Min. operating time for alarm 2 (defined for each channel)	$t_2$
$t_{R1 R2}$	Switching time from relay 1 to relay 2 (defined for the whole unit)	$t_{R1 \& R2}$



### 3.3.4. Fault thresholds

#### Processing of detector faults

Each channel detects the following faults.

#### For toxic and explosive gas detectors:

- line interrupted (0 mA),
- line short-circuited or excessive consumption,
- negative offset (more than 20% of measuring scale),
- line in calibration mode (2 mA) (if confirmed by programming).

For detectors of the explosive gas type (4-20 mA and 340 mA) in normal mode and if the measurement is greater than 100% of the measuring scale, there are the following immediate results:

- Display: SUP
- The relays are actuated if the thresholds are reached.
- The general fault relay is actuated.
- The 4-20 mA output of the channel is greater than 20 mA.
- ALL these states are memorized and the only way of acknowledging them is to switch off the channel and then restart it.

Faults are valid after a preprogrammed time (in the same way as alarms).

### FAULT BLOCK DIAGRAM

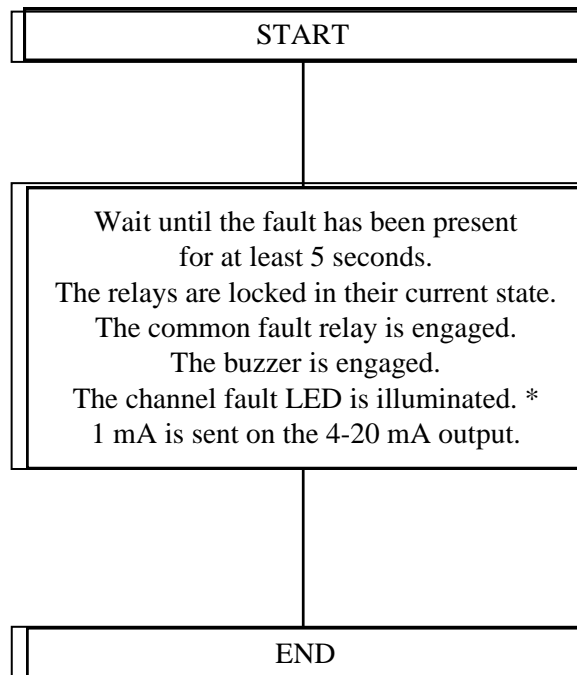

\* The LED is extinguished as soon a the fault disappears.

### 3.3.5. *Measuring unit*

One minute after starting up, and if no test action is performed on the keypad, the unit successively scans all the channels in service and displays the measured values.

#### **Examples of display**

**Channel 1**  
**x x LEL CH4**

OR

**Channel 2**  
**x x x ppm CO**

- Each channel is interrogated for 10 seconds.
- The user can interrogate a channel manually by selecting that channel with the + and - keys to obtain a manual display for one minute.
- The user can return to normal cyclic scanning during that one-minute period by simultaneously pressing the + and - keys. The display panel then shows alternating displays, three times in succession:

**For example:**

**Channel 5**  
**x x x ppm CO**

then

**normal scan**  
**x x x ppm CO**

## 4. UTILIZATION

---

### 4.1. List and functions of the various items of “USER” equipment for programming and calibration of the unit

---

#### 4.1.1. Keypad (see Figures 26 and 4)

This is equipped with four touch keys accessible without opening and swivelling the MX52 unit’s FRONT panel or opening and swivelling the FRONT panel for maintenance.

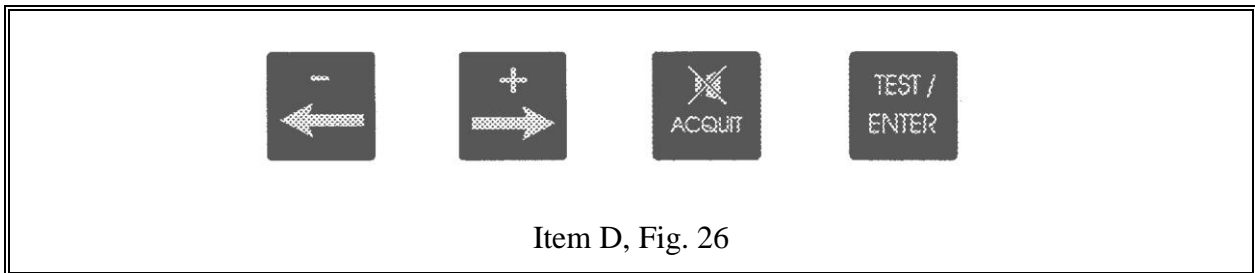

#### NORMAL MODE

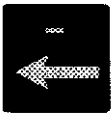

- Manual display of previous channel
- Combined with the “PLUS” key to restart the channels automatic display cycle.

#### MAINTENANCE MODE

- Manual display of previous channel
- Decrease value, threshold, etc.
- Display of previous choice (on  off, etc.)
- NO

#### NORMAL MODE



- Manual display of next channel
- Combined with the “MINUS” key to restart the channels automatic display cycle.

#### MAINTENANCE MODE

- Manual display of next menu
- Increase value, threshold, etc
- Display of next choice (on  off, etc)
- YES



- “Audio and visual” or “audio” clearing of an alarm
- Exit from a current menu



- Start a self-test manually
- VALIDATE

#### **4.1.2. Maintenance keys**

PROGRAMMING key (item B, Fig. 26): accessible after opening and swivelling the front panel.

- Combined with the “-” key to go back in a menu.
- To quit normal display mode and access the various menus (see block diagram of the various menus).
- To scroll through a menu.

CALIBRATION key (item C, Fig. 26): accessible after opening and swivelling the front panel.

- To set a channel to CALIBRATION mode.
- To quit that mode.

#### **4.1.3. Potentiometers**

On the FRONT circuit, each measuring channel has four potentiometers (item E in Figures 26 and 27). These are accessible by opening and swivelling the FRONT panel of the MX52 unit and are laid out as follows (see Fig. 27):

TOP (item A)	1 detector ZERO potentiometer 1 detector sensitivity potentiometer
BOTTOM (item B)	1 potentiometer 4 mA / current output 1 potentiometer 20 mA / current output (for full scale)

## 4.2. Menus

---

### 4.2.1. The various menus and their functions

The MX52 unit has five menus that are accessed by pressing the “Programming” key (item B, Fig. 26).

These five menus are as follows:

DESIGNATION	FUNCTION
“CHANNEL” programming	- To program the whole configuration of a measuring channel (ON/OFF, range, alarm thresholds, etc.)
“SIMULATION” programming	- To artificially vary a channel measurement on: - the display panel, - the 4-20 mA current output. - To trigger the alarms (LED and relays) at the same time.
“CHANNEL COPY” programming	- To copy the complete programming from one channel to another (time saving)
“UNIT” programming	- To program the whole configuration of the MX52 unit (language, slave number, etc.).
“UPLOADING” programming	- To transfer data, measurements and events, etc., from the unit to a computer via the MX52 unit’s RS 485 / J BUS output.

### 4.2.2. Block diagram of the scrolling of the various menus

It is easy to use these various menus by means of the keys on the keypad and the “Programming” key (items B and D, Fig. 26).

Detailed flow diagrams of the menu scrolling function and of each menu are given on the following pages.

**SCROLLING OF THE VARIOUS MENUS**

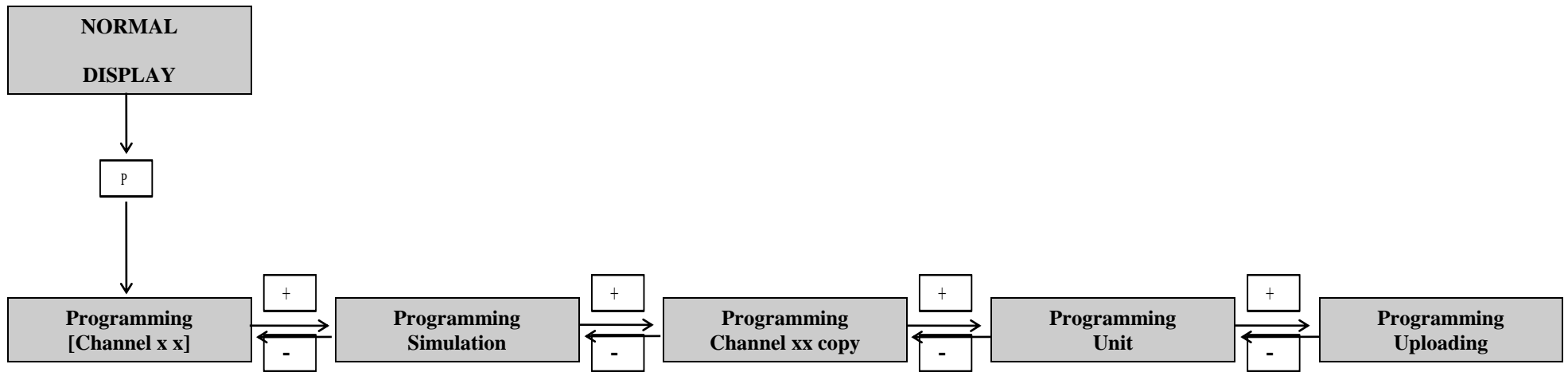

**REMINDER (Fig. 26)**

→ Programming key

→ Keys used to move

4.2.3. Detailed flow diagrams of each menu

**CHANNEL PROGRAMMING**

Remove on the programming socket before entering into programming

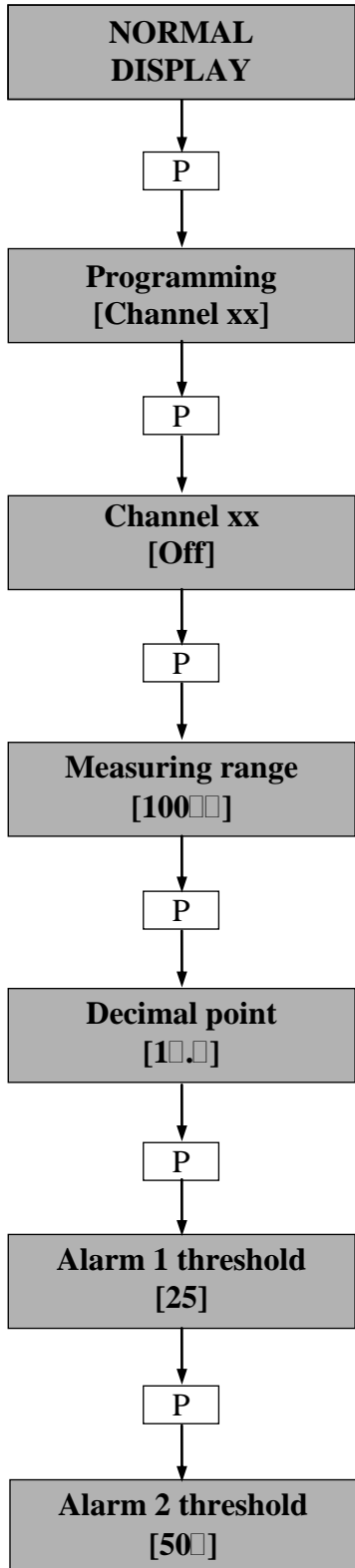

: last channel displayed

: Off                      On  
 +    ↔     -                      then   

: CHOICE OF RANGES  
 10    30    100    300    1000    2000                      xxxxxU  
 + →  + →  + →  + →  + →  +    then   

: SELECTION OF POINT POSITIONING  
 100    10.0    1.00    0.100    0.010    0.001  
 + →  + →  + →  + →  +    then   

: 0 to 2000  
 +    ↔     -                      then   

: 0 to 2000  
 +    ↔     -                      then

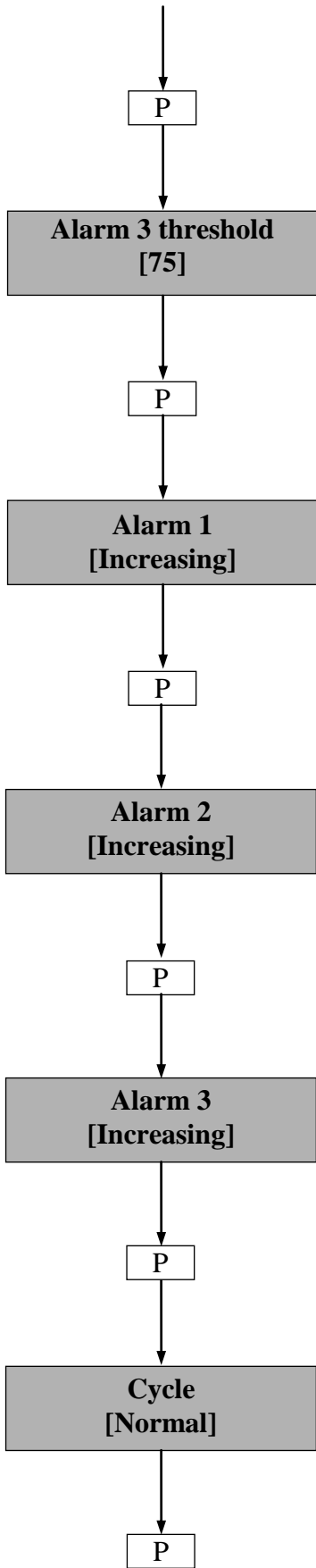

: 0 to 2000

↔

then

: Increasing

↔

Decreasing

then

: Increasing

↔

Decreasing

then

: Increasing

↔

Decreasing

then

: Normal

↔

Parking

then



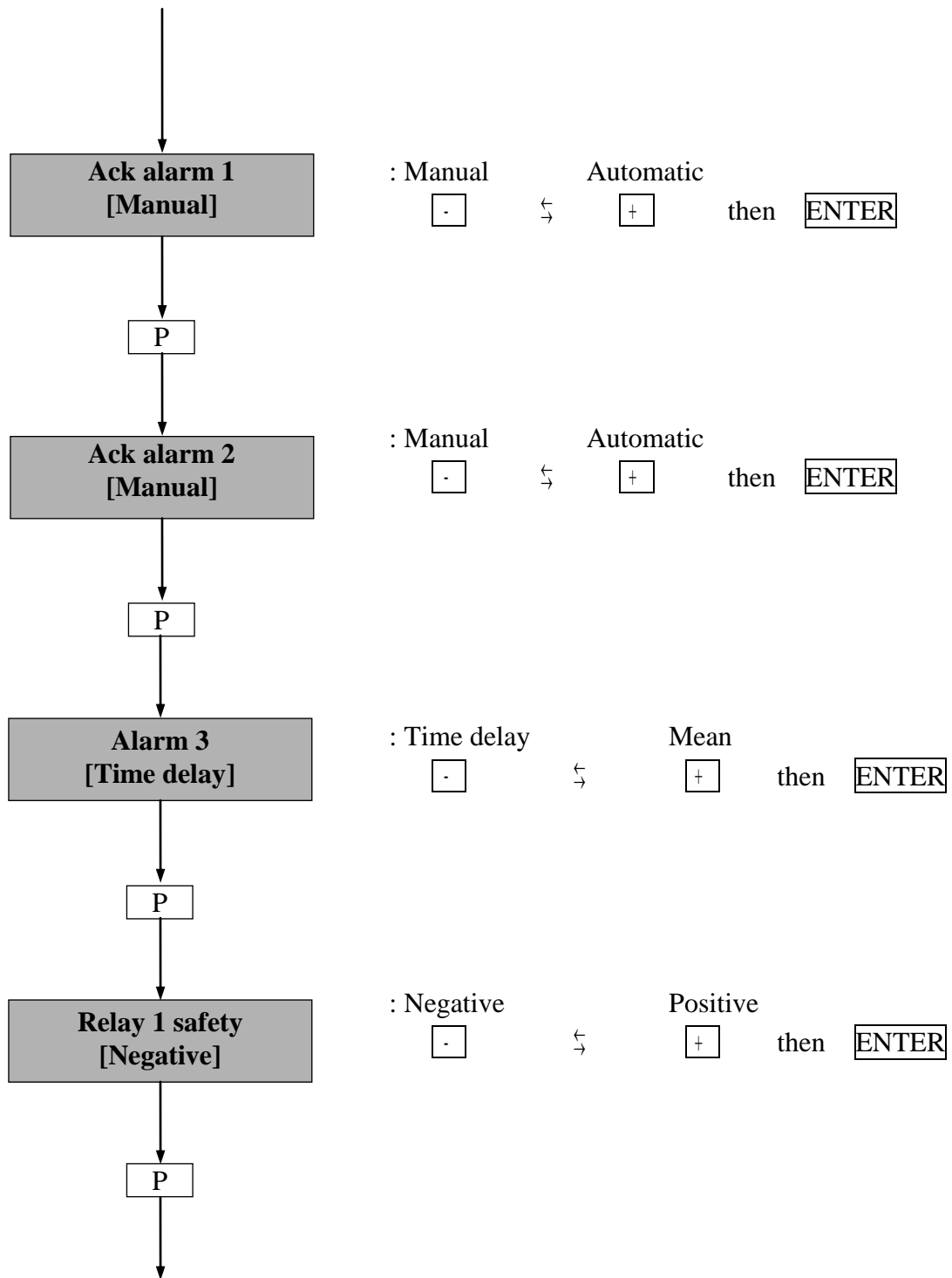

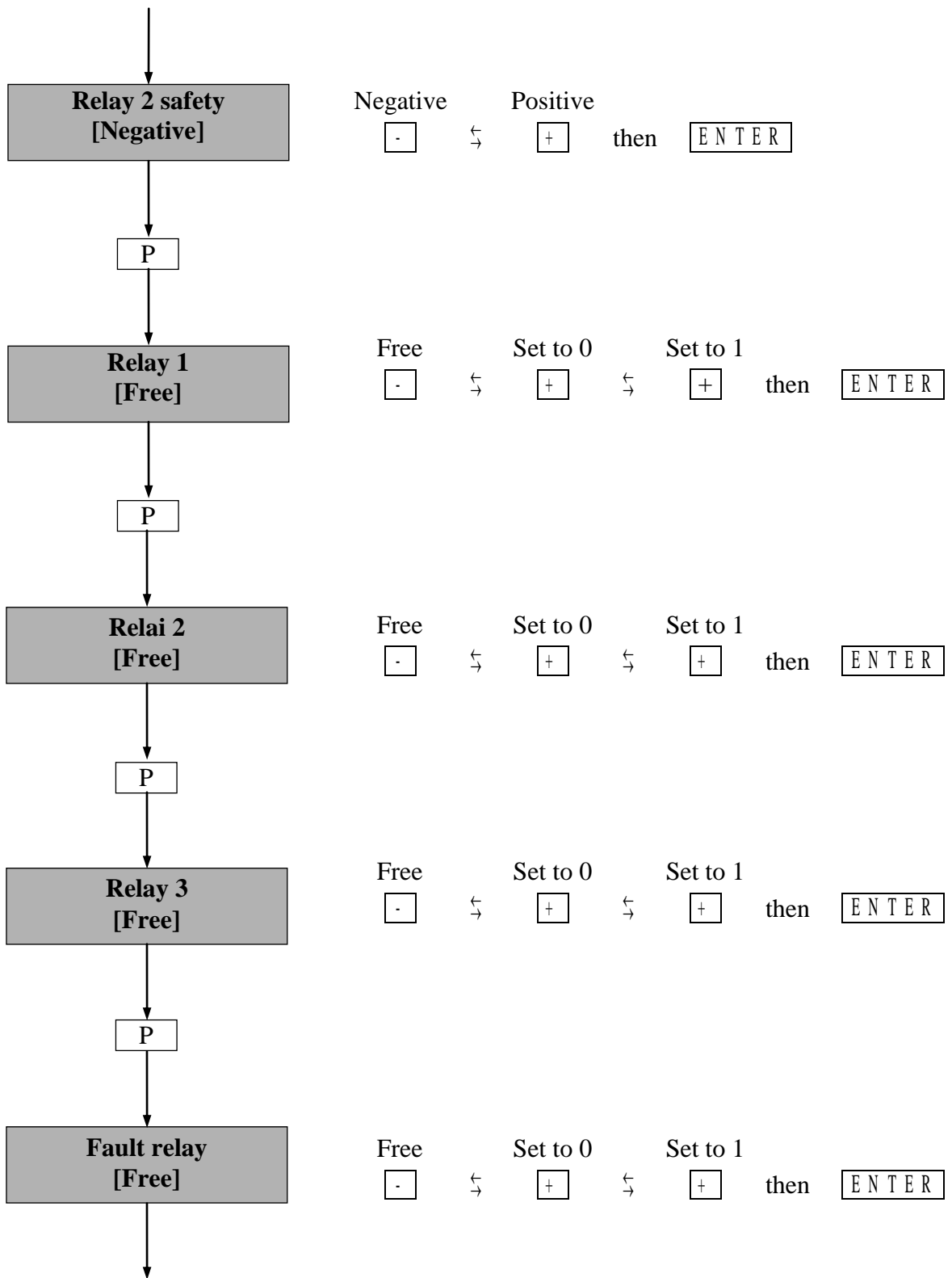

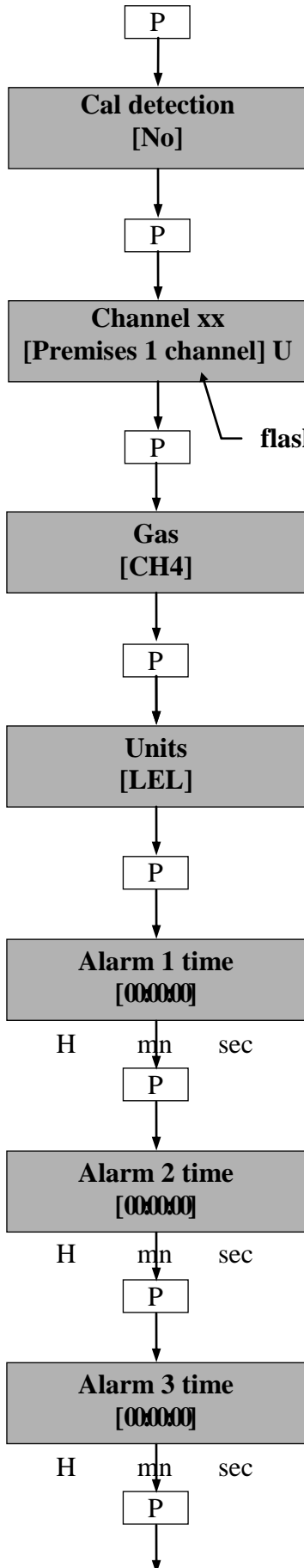

The MX52 unit can detect and indicate (with a flashing yellow LED) that a line has been placed in CALIBRATION mode on the detector.

No                      Yes  
 -                       +                      then   

Free display: A channel heading can be programmed (in 13 characters maximum). By default, the channel number is displayed in this area.

+                       -                      then   

CH4                      CO                      2S etc.  
 -                       +                       +                      then   

LEL                      %                      ppm etc.  
 -                       +                       +                      then   

Time: Time interval between the triggering of the AL LED and of the corresponding relay, or the minimum operating time of the relay in parking mode.

-                       +                      then   

Display of time by using keys

-                       +                      then   

Texte

-                       +                      then

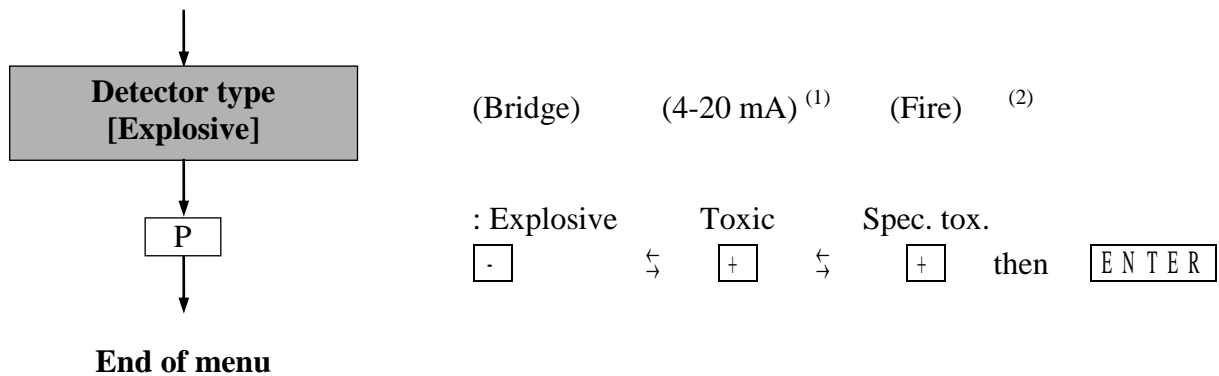

- (1) in case of "Up" fault : 3 "gas" alarms and fault alarm are triggered.
- (2) In case of "Up" fault : only the fault alarm is triggered.

**INFORMATION**



This key can also be used to exit from the current menu.

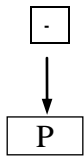

When in a menu, you can go back (to make checks or modifications, etc.) by pressing and holding **Programming** key and by successively pressing and releasing the down key **-**.

[   ]

Parameters specified in square brackets [ ] are the VALID parameters (in memory).

(1) Free

This means that the relay can be activated when programming alarm thresholds are triggered.

Set to 0

This means that the relay is not powered supply, and will not be activated by MX52 control unit with alarm..

Set to 1

This means that the relay is always powered supply (by the MX52 control unit), and neither will not be activated by MX52 control unit with alarm. Using of relays will be directly programmed by J-BUS input and "COM52" software.

## LIST OF UNITS

DESIGNATION	MEANING
LEL	Lower explosive limit
%	Percent
ppm	parts per million
ppb	parts per billion
UEG	Unter Explosion Grenze (= LEL in German)
LEL	Limite inférieure d'explosivité (= LEL in French)
bar	unit of pressure
mb	unit of pressure (millibar)
Rh	relative humidity
m/s	metres per second
mg	unit of weight (milligram)
unit + flashing U	free indication of unit <div style="text-align: center; margin-top: 10px;"> <input type="text" value="-"/>    <math>\zeta</math>    <input type="text" value="+"/>    then    <input type="text" value="ENTER"/> </div>

## LIST OF GASES

DESIGNATION	MEANING
CH4	Methane
CO	Carbon monoxide
H2S	Hydrogen sulphide
N	Nitrogen
NO	Nitric oxide
NO2	Nitrogen dioxide
SO2	Sulphur dioxide
Cl2	Chlorine
H2	Hydrogen
HCL	Hydrochloric acid
HCN	Hydrocyanic acid
NH3	Ammonia
ETO	Ethylene oxide
PH3	Phosphine
HF	Hydrofluoric acid
CFC	Freons
CO2	Carbon dioxide
ASH	Arsine
SiH4	Silane
BUT	Butane
PRO	Propane
GNT	Natural gas
ETY	Ethylene
PNT	Pentane
HEX	Hexane
PRY	Propylene
ACY	Acetylene
ETA	Ethanol
ACO	Acetone
OPR	Propylene oxide
OET	Ethylene oxide
ISB	Isobutane
DIM	Dichloromethane
AET	Ethyl alcohol
BUN	2-Butanol
ISP	Isopropanol
XYL	Xylene
TOL	Toluene
ESS	Petrol (gasoline)
BUD	Butadiene
HYD	Hydrogen
Gas + flashing U	Free indication of name of gas: <input type="text" value="-"/> § <input type="text" value="+"/> then <input type="text" value="ENTER"/>

# SIMULATION PROGRAMMING MENU

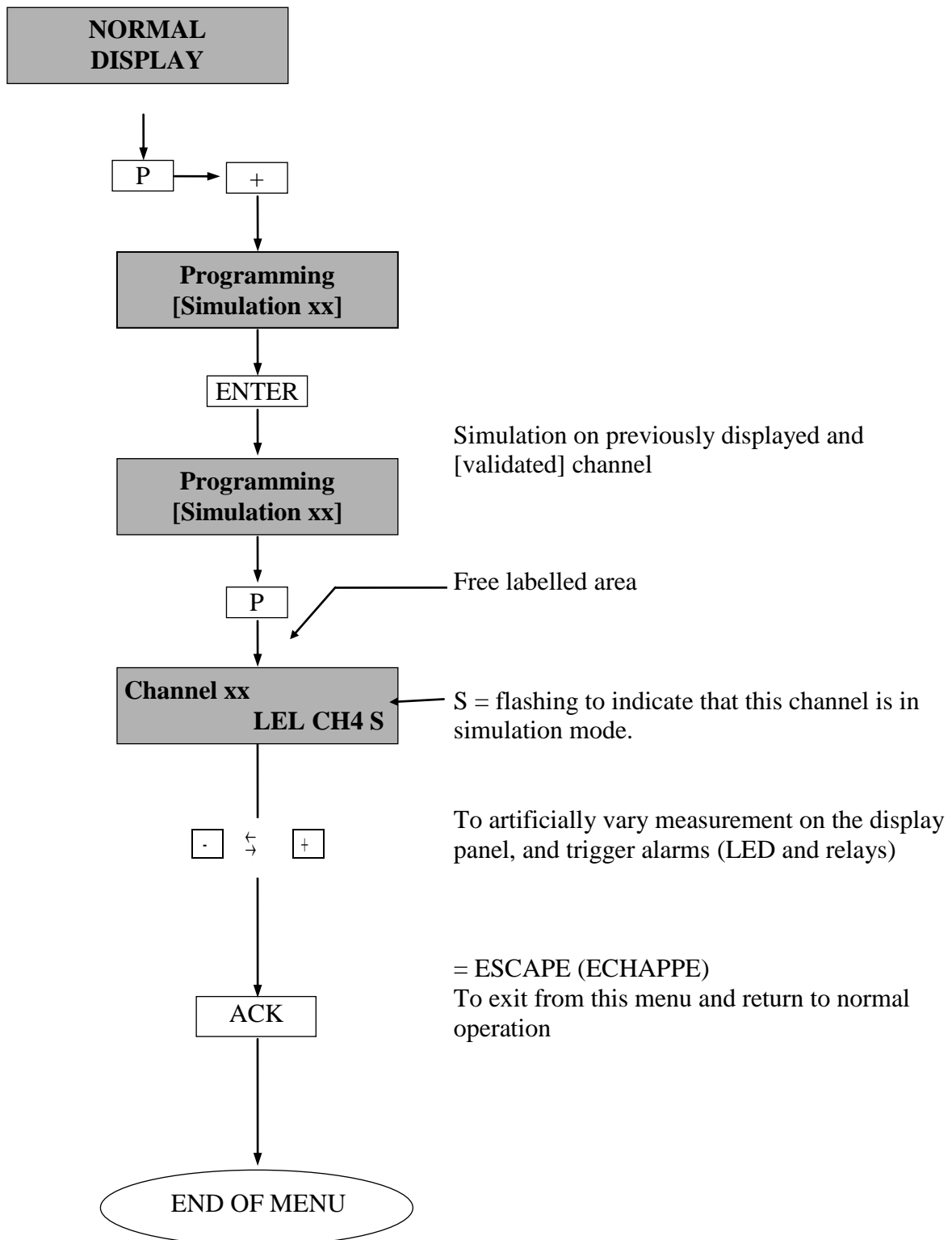

# COPY PROGRAMMING

NORMAL  
DISPLAY

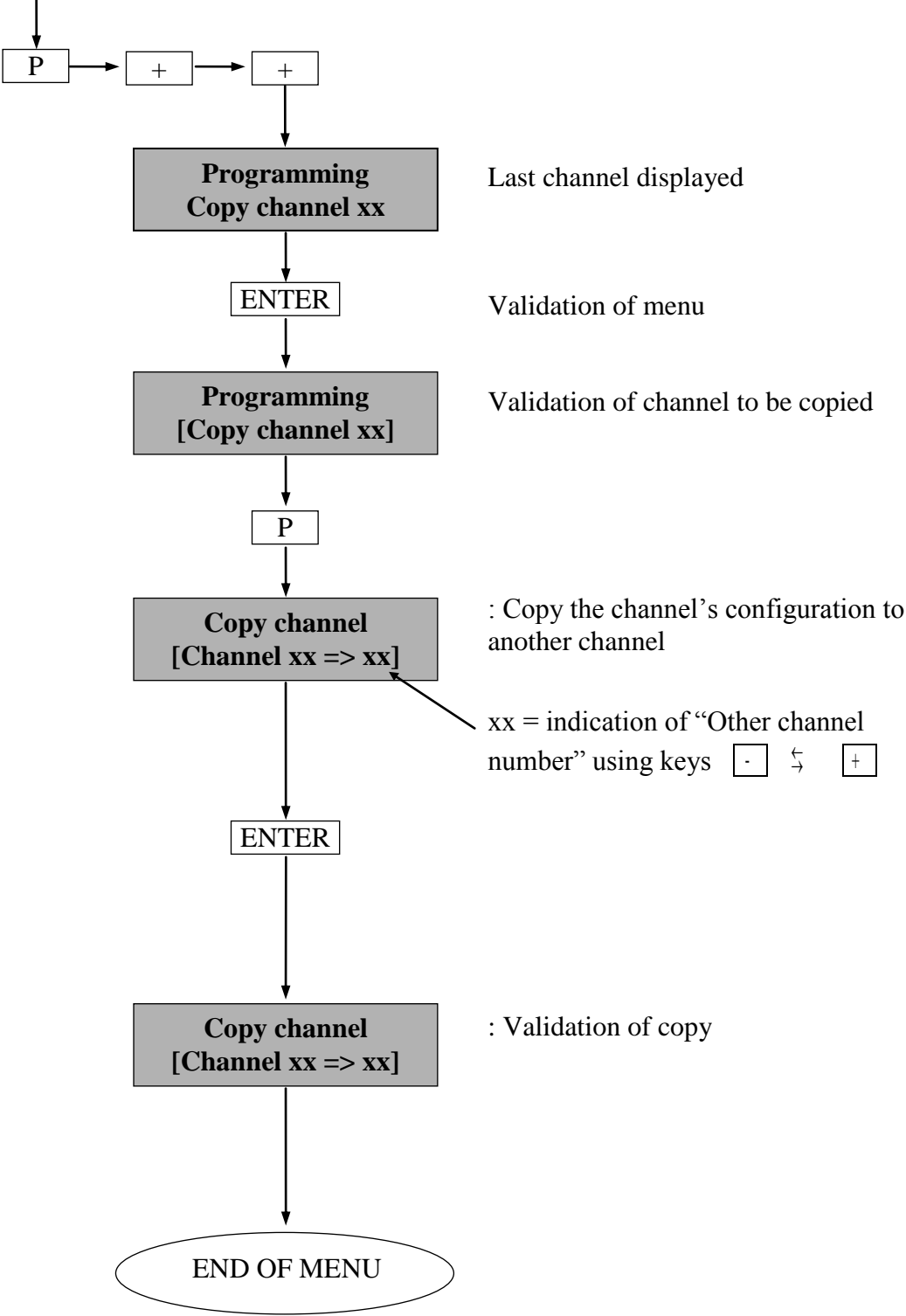



# UNIT PROGRAMMING

**NORMAL  
DISPLAY**

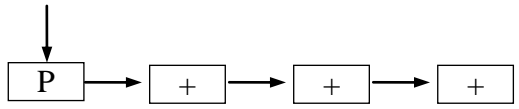

**Programming  
Unit**

ENTER

**Programming  
[Unit]**

Validation of menu

P

**Language  
[French]**

Choice of languages:

: French English German Spanish

+ → + → + then ENTER

P

**Speed  
[9600□]**

Choice of transmission speed with  
computer:

1200 2400 4800 9600 19200 Bauds

+ → + → + → + then ENTER

P

**Slave address  
[1]**

Choice of slave address (this unit)  
0 to 250

+ → then ENTER

P

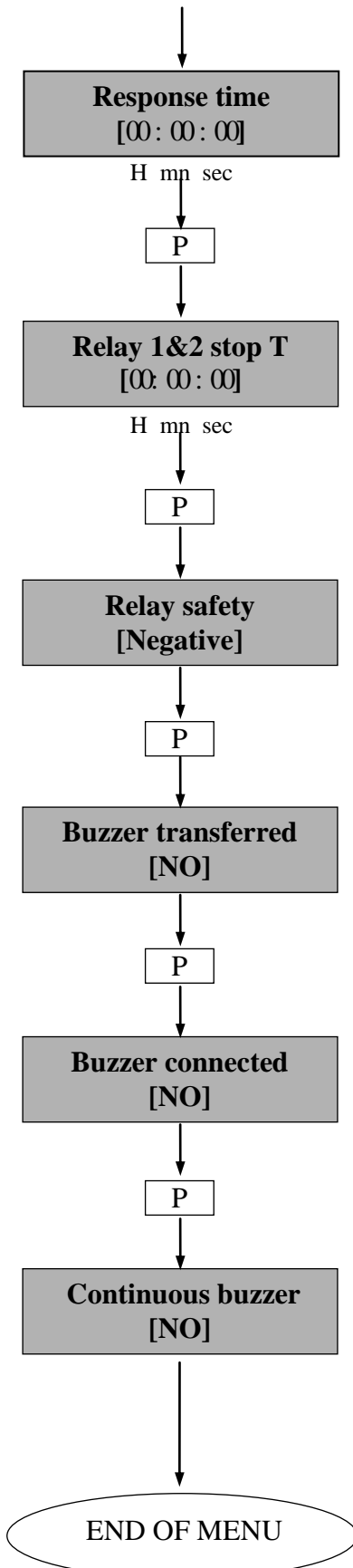

This is the time interval between exceeding of the AL threshold and triggering of the corresponding visual alarm (LED).

Display the time using keys:

↵  → then

In “Parking” mode: this is the time interval between stopping of relay 1 and starting of relay 2.

Display the time using keys:

↵  → then

Negative Positive

↵  → then

Control of relay 3 (common) by any triggering of buzzer

NO YES

↵  → then

Utilization of common audio alarm (buzzer)?

(Function in series with buzzer jumper)

NO YES

↵  → then

YES = If copy of buzzer on alarm 3 and with buzzer option into service : audible alarm will be triggered when there is an alarm.

NO = The common audible alarm (buzzer) will be triggered for a 30 seconds maximum time (even there is an alarm).

↵  → then

# UPLOADING PROGRAMMING

Only OLDHAM personnel and personnel approved by OLDHAM can be made this operation.

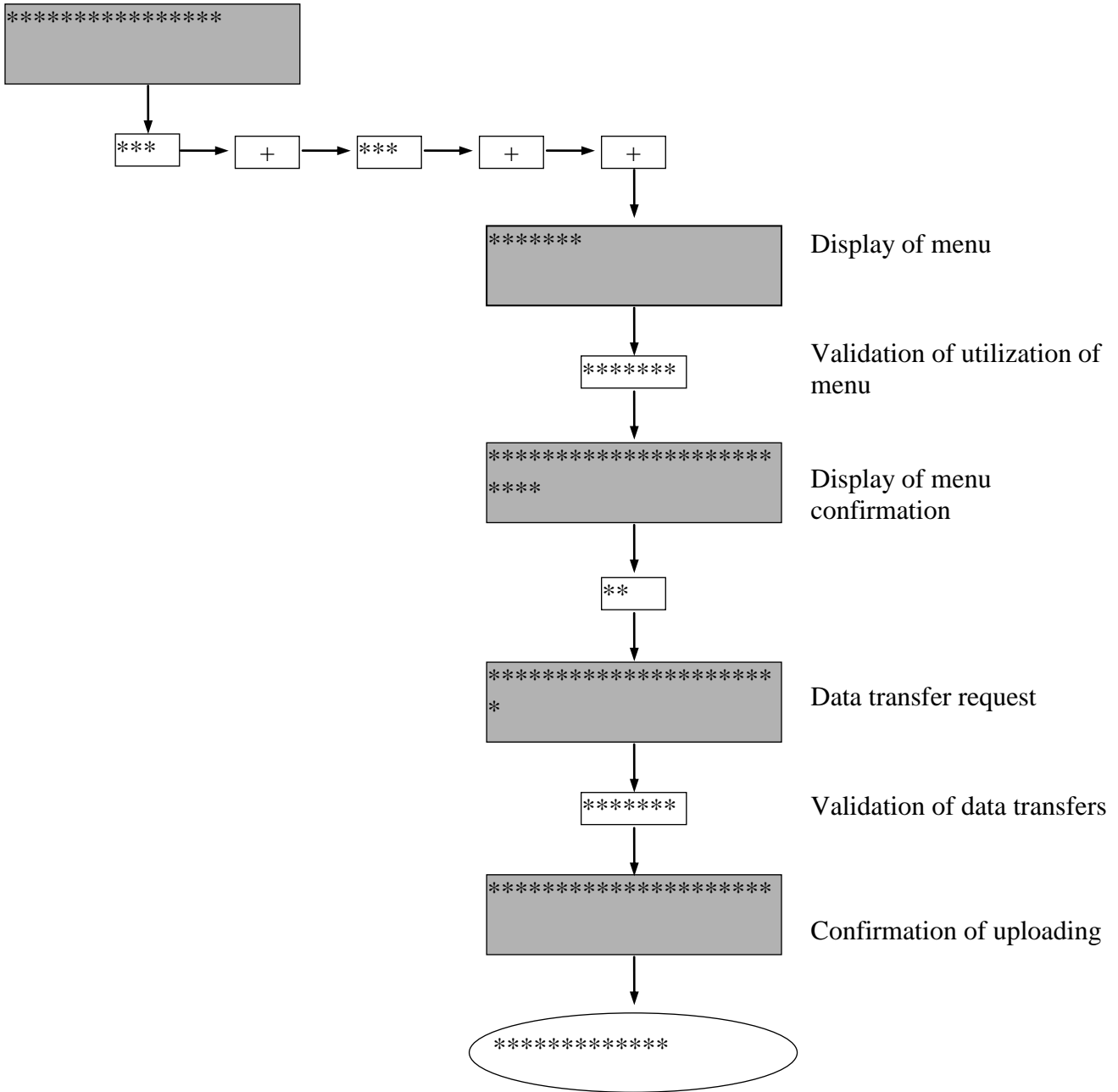



## 5. SETTING THE MX52 UNIT INTO SERVICE

---

### REMINDER

The handling operations and adjustments described in this chapter must be performed by authorized personnel only, as they are liable to affect detection safety.

Once the measuring unit has been switched on, it can be programmed (1), its measuring channels can be programmed (1) according to the detectors used and calibrations can be made on the unit and detectors.

(1) These programming operations can be carried out directly on the MX52 unit in accordance with the following procedures or using a computer equipped with the “com 52” software.

### 5.1. *Programming the unit*

---

To program the MX52 measuring unit, and according to the required specifications, the “Unit programming” menu must be used (see Section IV-2 on Menus) by means of the keypad and the “Programming” key. Then, the instructions in the menu should simply be followed.

### CAUTION

If the unit remains in programming mode for more than 30 minutes, it automatically switches to fault mode.

### 5.2. *Programming the measuring channels*

---

#### 5.2.1. *Programming*

To program each measuring channel according to the type of detector used and the required specifications, the “Channel programming” menu must be used (see Section IV-2 on Menus) by means of the keypad and the “Programming” key. Then, the menu instructions should simply be followed.

### REMARK

When a channel is switched on, all its relays are in “off” mode and its current output is 1 mA. Then, one minute later, the channel comes into effective operation (relays ready and output of 4-20 mA).

### CAUTION

If a channel remains in programming mode for more than 30 minutes, it is automatically switched to fault mode.

### 5.2.2. Copy

In order to make the programming of ALL CHANNELS less TIME-CONSUMING when the same programming is required for a number of channels, it is recommended that the “COPY” menu should be used (see Section IV-2 on Menus) by means of the keypad and the “Programming” key. Then, the instructions in this menu should simply be followed.

## 5.3. Calibrations

---

Gas detection instruments are potential life-saving devices. Recognizing this fact, OLDHAM Corporation recommends that a functional “bump” test be performed on every fixed gas-monitoring instruments as part of a regular maintenance program. A functional test is defined as a brief exposure of the detector to a concentration of gas(es) in excess of the lowest alarm set-point for each sensor for the purpose of verifying sensor and alarm operation and is not intended to be a measure of the accuracy of the instrument.

OLDHAM further recommends that a full instrument calibration be performed using a certified concentration(s) of calibration gas(es) quarterly, every 3 months.\* Calibrations may be necessary more or less frequently based, for example, on application, field conditions, exposure to gas, sensor technology, and environmental conditions. The frequency of calibration is best determined by company policy or local regulatory agencies.

If an instrument fails to operate properly during any functional “bump” test, a full instrument calibration should be performed successfully prior to use.

These recommendations are based on safe work procedures, industry best practises, and regulatory standards to ensure worker safety. OLDHAM is not responsible for setting safety practices and policies.

*\* For new installations it may be prudent to carry out bump tests frequently at first (perhaps weekly), increasing the time intervals (to, perhaps, monthly or more) as confidence grows with experience in the installation concerned, on the basis of the maintenance record.*

#### **Case 1**

**Measuring channel connected to a detector with no integrated electronics (explosive gas detector).**

- Prepare the detector for calibration:
  - Calibration consists in adjusting the detector ZERO in PURE AIR and its sensitivity to the STANDARD GAS.
  - If the detector zero is set with natural diffusion in pure air, the surrounding atmosphere must be calm (wind speed of less than 1 m/s).

## REMARK

The authorized wind speed is increased to 4.1 m/s when the detector is fitted with a weather protective device.

- Prepare the measuring channel for calibration:
  - Open and swivel the front panel of the MX52 unit.
  - Manually set the channel to be calculated using keys + and - on the MX52 keypad (item D, Fig. 26).
  - Press the CALIBRATION key (item C, Fig. 26).
  - At the bottom right-hand side of the display panel, the letter C flashes and the yellow LED for the relevant channel flashes, indicating that the measuring channel is in the “CALIBRATION” position.

## REMARK

When a measuring channel is in the CALIBRATION position, all the alarm relays are inhibited (in order to avoid interfering with the slaving control networks) and the corresponding current output is maintained at 2 mA.

- Turn the sensitivity potentiometer (item A, Fig. 27) five times in the clockwise direction (using a screwdriver).
- Adjust the DETECTOR ZERO.

## NOTE

If the ambient air is not pure, inject air using a “synthetic air” cylinder and the gas injection pipe or a remote calibrating fixed device with a flow rate of 60 litres per hour for 25 seconds directly on the detector or a flow rate of 170 litres per hour for 1 min 45 s using a remote calibrating fixed device.

As soon as the signal is stable on the MX52 display panel, adjust the “MEASUREMENT ZERO” by adjusting the ZERO potentiometer (item A, Fig. 27) and corresponding to channel to be set up, so as to read ZERO on the MX52 display panel.

- **Adjust the detector sensitivity:**
  - Inject the calibration gas using the gas injection pipe (or a remote calibrating fixed device) in the same conditions as those applicable for the synthetic air (zero adjustment).

When the measurement has stabilized, set the value corresponding to the reference gas concentration on the display panel of the MX52 unit by adjusting the sensitivity potentiometer for the relevant channel (item A, Fig. 27).

## NOTE

For this category of explosive gas detectors, the unit's display panel indicates 100 DIVISIONS for 100 LEL of an explosive gas.

### Example:

If the reference gas is a 2.5% methane concentration, i.e. 50% LEL of methane, adjust to obtain a display of 50 DIVISIONS.

### Formula:

$$\text{Number of divisions to be set} = \frac{\text{Maximum scale} \times 100 \text{ DIV} \times n\% \text{ LEL of standard gas}}{100\% \text{ LEL}} = \frac{\text{Maximum LEL}}{100\% \text{ LEL}}$$

- Stop the injection of the standard gas, wait for the measurement to return to zero (on the MX52 display panel). Then, press the "CALIBRATION" key (item C, Fig 27). The flashing yellow LED is extinguished and the "C" on the display panel disappears. The measuring channel now operates normally an calibration has been completed.

### Case 2

**Measuring channel connected to a detector with no integrated electronics and supplying a standardized 4-20 mA current. (CTX50, CTX100, CTX200, CTX870, etc.).**

- Prepare the detector for calibration:
  - See the remarks for zero adjustment in pure air and natural diffusion as in case 1.
  - These types of detector (4-20 mA) often have a "CALIBRATION" position (CTX870, CTX100, etc.) or a calibration menu (CTX2042, COX2040, etc.). This position has the effect of transmitting a 2 mA current from the detector to the measuring unit.
  - This prevents the triggering of alarms (and slaving controls) during calibrating operations.



**CAUTION**

**If the detector and the measuring channel are calibrated at the same time, the detector must be left in normal operating mode but the MX52 unit must be set to calibration mode in order to inhibit the relays.**

⇒ Consult the technical manual for the detector concerned.

- Open the detector (with integrated electronics) in order to gain access to the 4 mA adjustment and sensitivity (20 mA) potentiometers and to the terminals used to check its 4-20 mA output current.
- With these types of detector, there are two ways of checking the current supplied to the unit:
  - by direct reading on the local display panel (internal to the detector)
  - by measurement of current on the terminals provided for that purpose (see the manual for the detector concerned).
- Prepare the measuring channel for calibration:
- same operations as in case 1.

- **Adjust the detector zero.**

**NOTE**

If the ambient air is not pure, inject air using a “synthetic air” cylinder and the gas injection pipe or a remote calibrating fixed device with a flow rate of 60 litres per hour for 25 seconds directly on the detector or a flow rate of 170 litres per hour for 1 min 45 s using a remote calibrating fixed device.

As soon as the signal is stable on the local display panel on the detector or with regard to the current output (4-20 mA), adjust the DETECTOR ZERO by adjusting the detector internal ZERO potentiometer (see the manual for the detector concerned).

Then, CONSECUTIVELY, adjust the measurement zero by acting on the ZERO potentiometer for the measuring channel (Item A, Fig. 27) so as to read ZERO on the MX52 display panel.

- **Adjust the detector sensitivity:**

- Inject the calibration gas using the gas injection pipe (or a remote calibrating fixed device) in the same conditions as those applicable for the synthetic air (zero adjustment).

When the measurement has stabilized (on the local display panel or on the detector internal terminals (current measurement)), act on the detector's internal sensitivity potentiometer (see the manual for the detector concerned) in order to set the value (on the detector display panel) corresponding to the concentration of the reference gas or the corresponding current (terminals). (See the note and examples for case 1).

- Then, CONSECUTIVELY set the value of the standard gas on the MX52 display panel by acting on the measuring channel sensitivity potentiometer (Item A, Fig. 27).
- Stop the injection of the standard gas, wait for the measurement to return to zero (on the MX52 display panel). Then, press the "CALIBRATION" key (item C, Fig. 27). The flashing yellow LED is extinguished and the "C" on the display panel disappears. The measuring channel now operates normally and calibration has been completed.

#### ***5.4. 4-20 mA output adjustment for a measurement channel***

---

➤ **4 mA adjustment**

- for a zero display
- check<sup>1</sup> the 4 mA output current and adjust it if necessary using the 4 mA potentiometer : see fig 27 rep B.

➤ **20 mA output adjustment**

- following the measurement display and the following formula :

**Maximum scale**

$$I = \frac{4\text{mA (0-DIV)} + 16 \text{ mA} \times \text{Number of divisions set}}{100 \text{ DIVISIONS}}$$

- Check<sup>1</sup> the 4 mA output current and adjust it if necessary using the 20 mA potentiometer : see fig 27 rep B

---

<sup>1</sup> Current reading is possible by connecting directly the corresponding output current (see fig 12) a "continuous" milliammeter.

## 6. MAINTENANCE

---

### REMINDER

The handling operations and adjustments described in this chapter must be performed by authorized personnel only, as they are liable to affect detection safety.

### 6.1. *Periodic / preventive maintenance*

---

#### 6.1.1. *On the MX52 unit*

The MX52 measuring unit requires practically no surveillance. It is, however, recommended that the facilities available on the MX52 unit should be used to regularly test the appliance's essential functions, as follows:

Use the TEST key to check the correct operation of all the LEDs and the buzzer.

Use the "SIMULATION" menu to check the correct operation of the display panel, the triggering of alarms (LED and relays), the slaving controls and the 4-20 mA current output.

Cause a fault to occur (such as a line fault by disconnecting a detector wire) to check the correct operation of the fault "stages".

#### 6.1.2. *On the detectors*

The detectors must be calibrated at least twice a year.

##### Case 1

Detectors without integrated electronics (CAPTEX, CEX800, CEX810, etc.)

With this type of detector, the zero and sensitivity adjustments must be made on the MX52 unit. SEE THE CHAPTER ON CALIBRATIONS (see 5-3, case 1) and carry out the operations specified.

##### Case 2

Detectors with integrated electronics (CTX50, CTX100, CTX870, etc.)

With this type of detector, and for periodic maintenance, all that is required is action on the detector. SEE THE CHAPTER ON CALIBRATIONS (see 5-3, case 2) and carry out the operations specified.

**NOTE**

Our company is at your disposal to supply you with standard gas or an annual surveillance contract (preventive maintenance). Under this contract, our specialists guarantee the perfect operation of your installation. No adjustment is to be made between OLDHAM servicing operations. This avoids any additional workload for the user's maintenance services.

**6.2. Failures: causes and remedies**

<b>FAILURES</b>	<b>CAUSES</b>	<b>REMEDIES</b>
Display channel not lit up and no indicator light on.	On/Off switch in the Off position.	Set the switch to the On position (item A, Fig. 26).
	Problem with mains power supply or DC power supply (24 V DC).	Check the supply voltages on input to the MX52 unit and, if necessary, check in the electric power supply cabinets.
	Mains fuses blown.	Replace the mains fuses (see item A, Fig. 5).
	DC power (24 V DC) input fuses blown.	Replace the 24 V DC fuses located at the back of the MX52 unit (item B, Fig. 5).
	+24 V DC internal protection fuse blown.	Replace the +24 V DC fuse located on the power board (item C, Fig. 5).
	<b>CAUTION</b> <b>When replacing a fuse, it is mandatory to comply with the required type and rating.</b>	
Fault indicator light on (in steady mode).	Faulty electrical connections on the telemetry line (wires and detector).	Check the connections on the MX52 terminal block and the detector terminal block. Check that there is no short circuit or break in the wires on the telemetry cable.
	Faulty detector.	Repair or replace the detector (see internal electronics or cell).
	The type of detector does not match the measuring channel configuration.	Connect the correct type of detector with the corresponding measuring channel. <b>CAUTION</b> The measuring channel or line may be damaged.
	Negative offset too great (more than 20% of measuring scale).	Perform calibration on the detector and, then, on the unit, if necessary. If the problem persists, the cell must be replaced.

	Channel in maintenance mode for more than 30 minutes.	Return the channel to normal operation by pressing the Calibration key (Item C, Fig. 26).
Fault indicator light on (in steady mode) and SUP displayed.	The measurement is higher than 100% of the measuring scale.	To acknowledge the alarm, the measuring channel must be switched off and then switched on again (by programming). If the problem persists and the measurement is not consistent with reality, the detector must be calibrated.
An LED does not light up even though the corresponding threshold is exceeded and the buzzer and relay are actuated.	Faulty LED.	Perform a general test on the LEDs by pressing the <b>TEST</b> key on the keypad (Fig. 26) and, if the LED still does not light up, the programming must be modified by using the “Unit programming” menu (buzzer connected?).
An alarm is triggered, the LED lights up and the relay is actuated but there is no audio alarm.	The buzzer strap is not correctly positioned.	Fall the buzzer switch (Fig. 26).
	The buzzer is not programmed as “in service”.	If the audio alarm is wanted, the programming must be modified by using the “unit programming” menu (buzzer connected?).
The audio alarm stops after 30 s although alarms are still actuated.	The buzzer is programmed to operate for 30 seconds only.	If the buzzer is to be sounded as long as the alarms are actuated, the programming must be modified by using the “Unit programming menu” (continuous buzzer?).
An alarm is triggered but the slaving controls are not actuated.	The relays are faulty.	Short-circuit or open the relay contact (as applicable) on the MX52 terminal block (Fig. 12) and, if the slaving controls operate normally, the corresponding channel board must be repaired by an approved technician.

	Faulty electrical connections.	Short-circuit or open the relay contact (as applicable) on the MX52 terminal block (Fig. 12) and, if the slaving controls still do not work, the connections must be checked on the MX52 connector and on the slaving systems.
An electronic detector is in the "CALIBRATION" position and the corresponding channel of the MX52 unit remains in normal operation: no flashing yellow LED. Impossible to upload data from the MX52 to a computer.	The channel is not programmed to detect a detector in "Calibration" mode.	If it is so wished, the programming of this channel can be modified by using the "Channel programming" menu (self-calibration) and choose "CAL detection : YES".
	Faulty electric connections.	Check the connections on the MX52 unit connector (item A, Fig. 6) and the computer. Check that the cable is satisfactory.
Remote acknowledgement is impossible.	The cable does not match the 2-wire RS485 type of link.	Replace the cable with a suitable one.
	Faulty electric connections.	Check the connections on the MX52 unit connector (item B, Fig. 6) and on the punch-type button.
	The punch-type button is faulty.	Replace the punch-type button.

### 6.2.1. Data printing

#### EXAMPLE

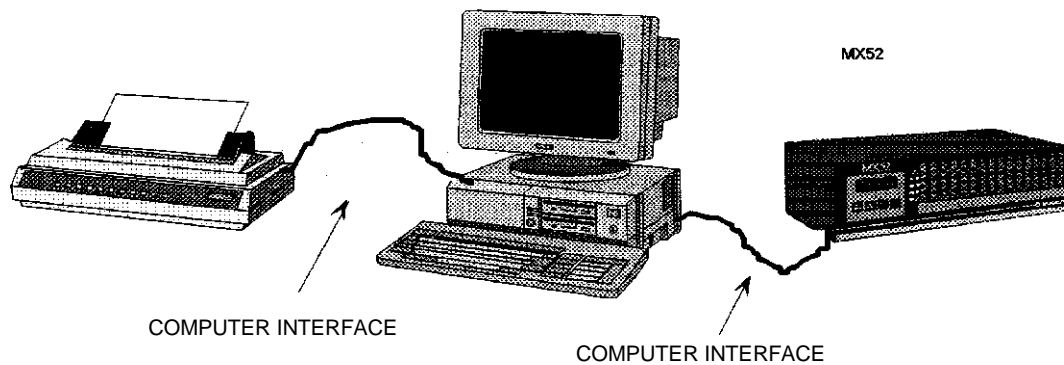

#### CAUTION

A computer must, imperatively, be used to print data.

### 6.3. *Scrapping of MX52*

Concerning the conservation, of the protection and the improvement of the quality of the environment, as well as for the protection of the health of the persons and the careful and rational use of natural resources, MX52 has to be the object of a selective collection for the electronic equipments and cannot be scrapped with the normal domestic waste. The user thus has the obligation to separate the MX52 of the other waste so as to guarantee that it is recycled in a sure way at the environmental level. For more details of the existing sites of collection, contact the local administration or the distributor of this product.

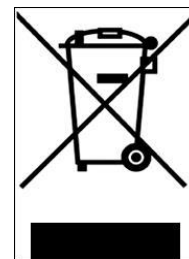

### 6.4. *List of spare and replacement parts*

DESIGNATION	REFERENCE
Complete power unit	6311078
Power board	6451422
Toroidal transformer	6111194
Mains power supply fuse, 2 A, time-delayed	6154697
DC power supply fuse, 12.5 A, time-delayed	6154721
Power board relay (DC)	6155745
Common alarm relay	6155752
AC mains relay (110 V AC)	6155761
MICRO board	6451423
Lithium battery (on micro board)	6111174
“Measuring channels” board	6451424
“Measuring channel” fuse, 630 mA, time-delayed	6154627
Fuse, 125 mA, time-delayed	6154701
“Channel actuating” relay	6155744
“Measuring channel” alarm relay	6155752
Complete main board (FRONT)	6451425
Buzzer	6112214
Fluorescent display panel	6133521
On/Off switch	6153436
Maintenance screwdriver	6145845

#### **CAUTION**

**It is mandatory that replacement parts must be guaranteed OLDHAM FRANCE original parts as, if this is not the case, the safety of the equipment could be affected.**





## 7. VIEWS SPECIFIED IN THE MANUAL

---

VIEWS SPECIFIED  
IN THE MANUAL

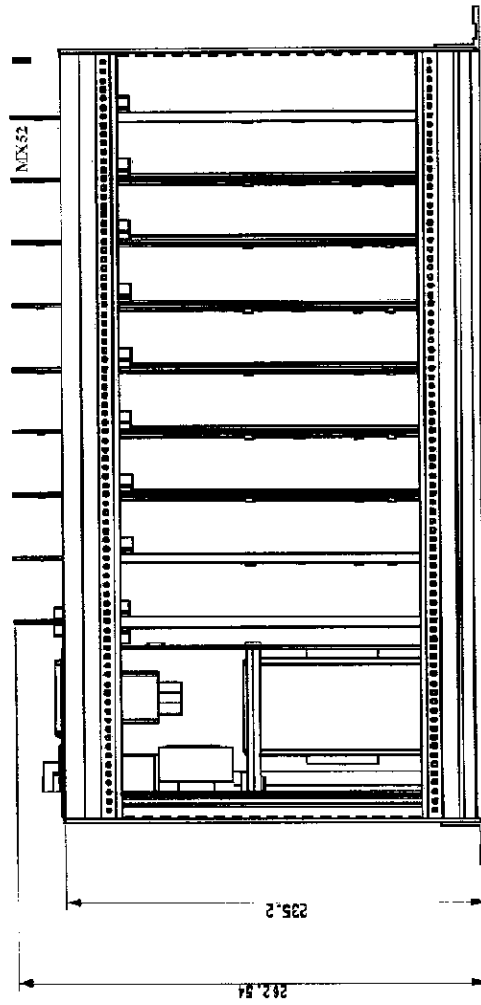
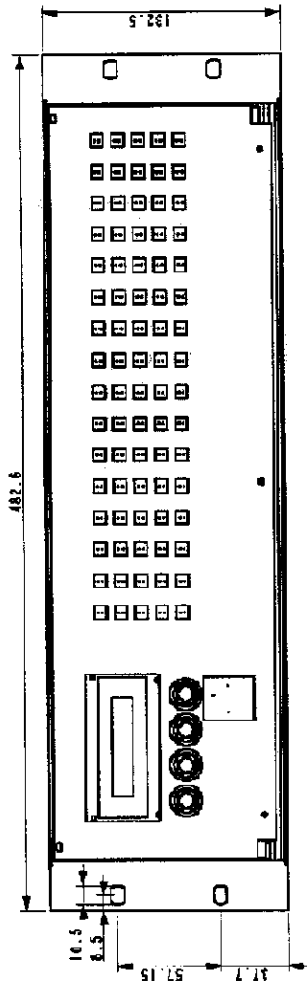

MX52 OVERALL DIMENSIONS - Fig 1

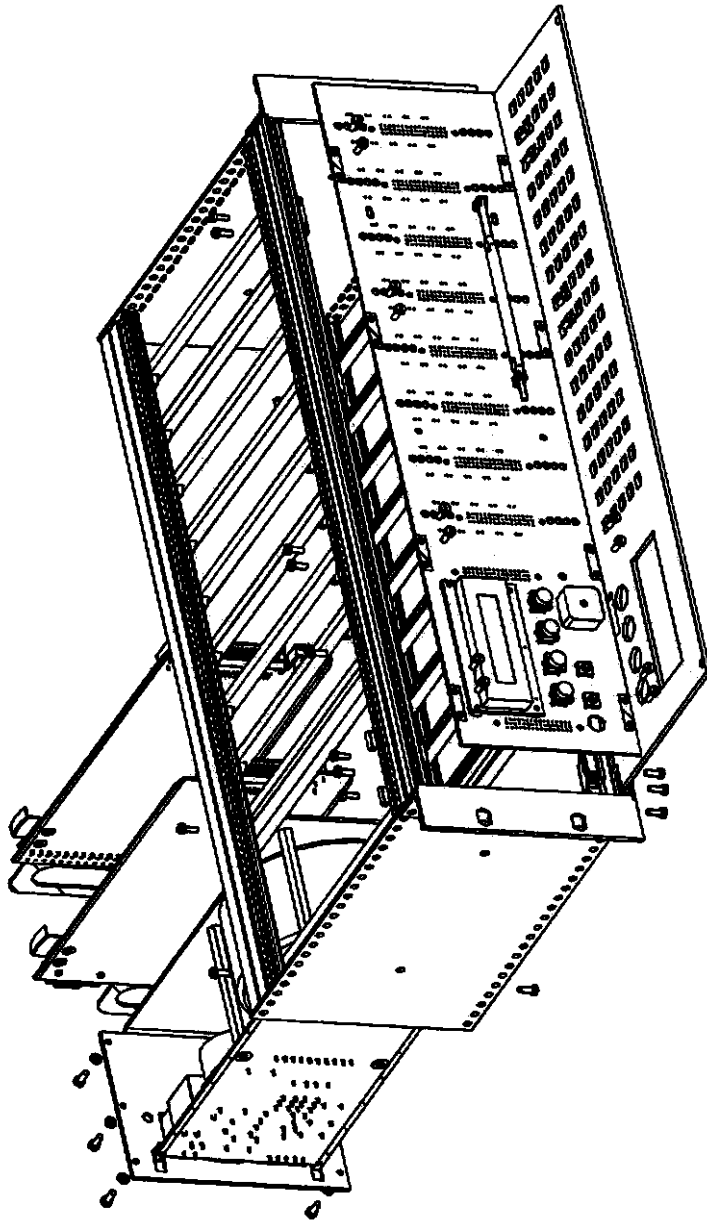

OVERALL VIEW  
FRONT PROFILE - Fig. 2

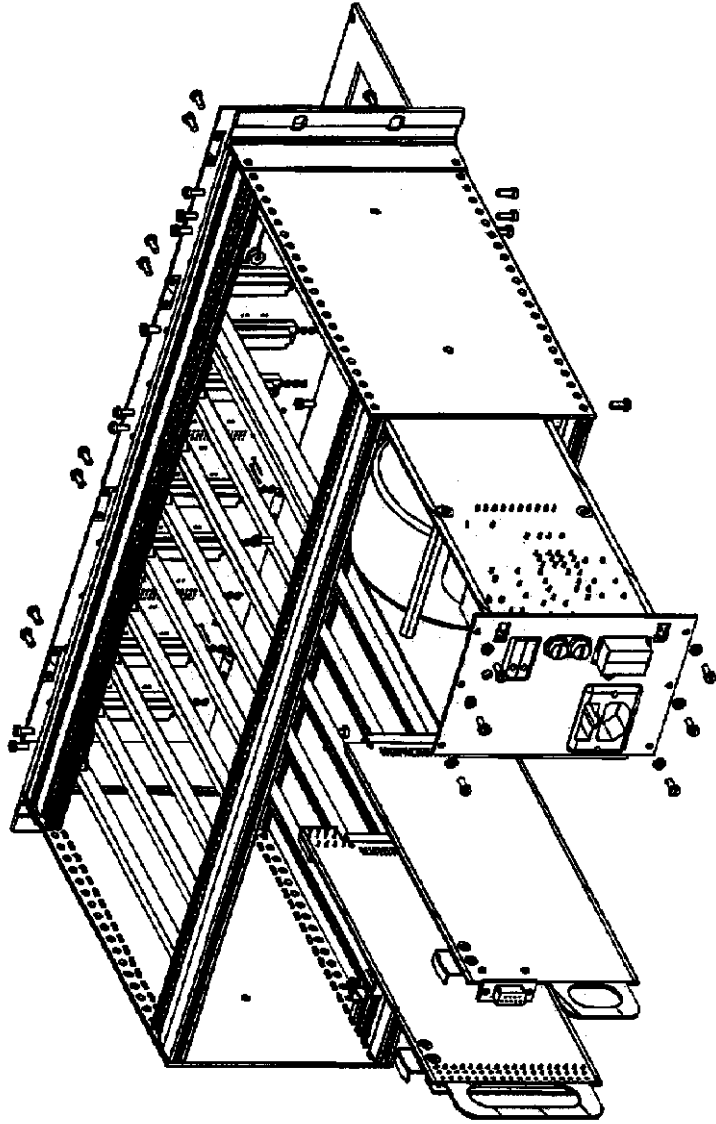

OVERALL VIEW  
REAR PROFILE - Fig. 3

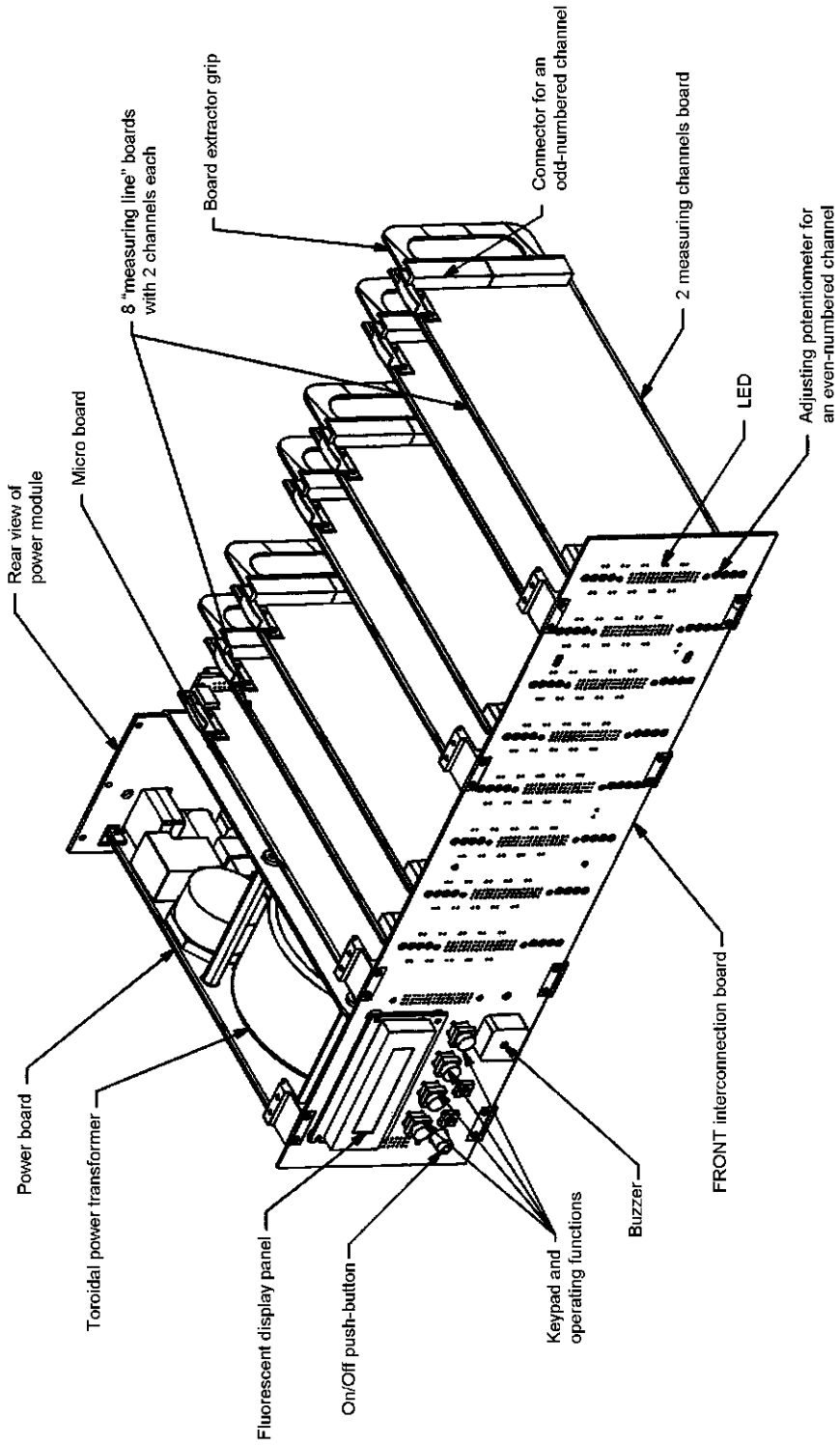

**MX INTERNAL COMPOSITION - Fig. 4**

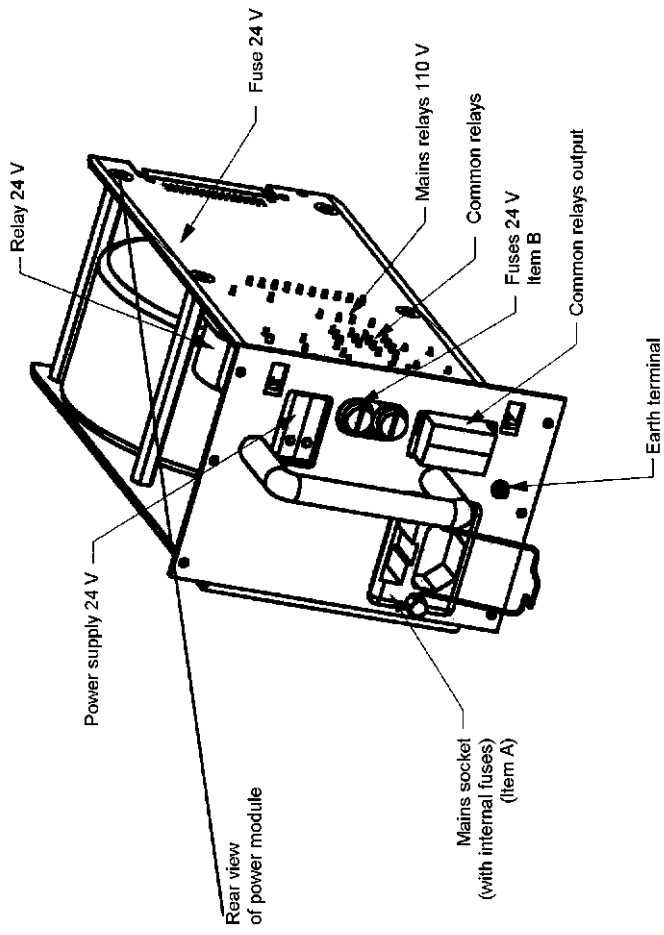

**POWER BOARD AND MODULE - Fig. 5**

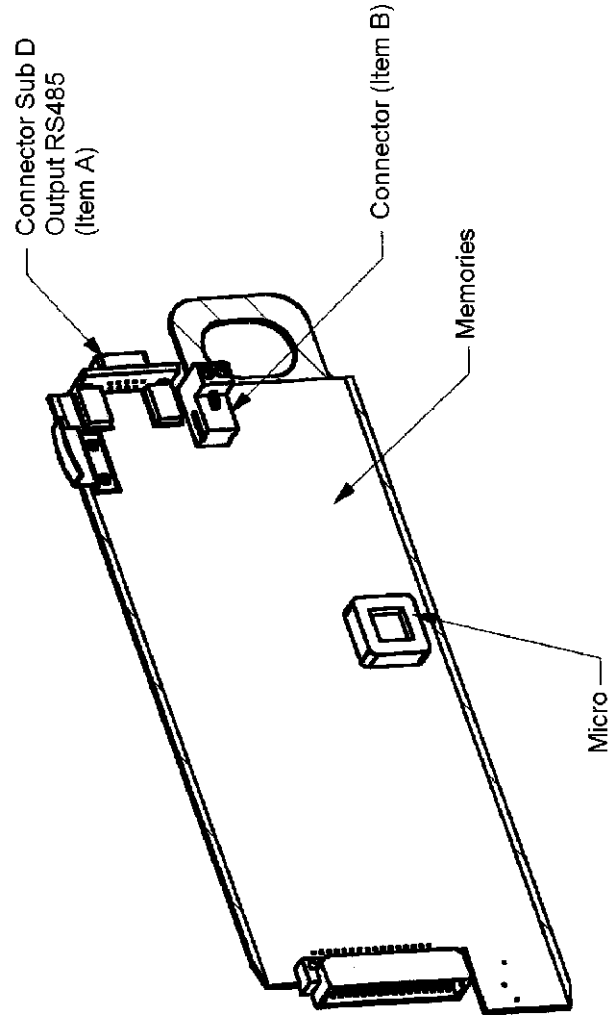
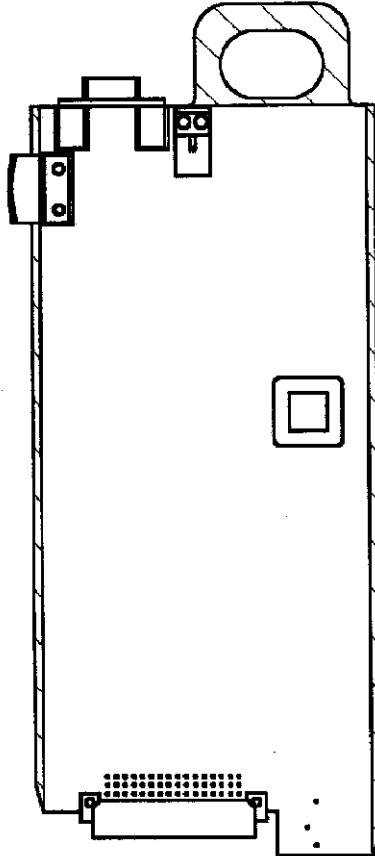

**MICRO BOARD - Fig. 6**

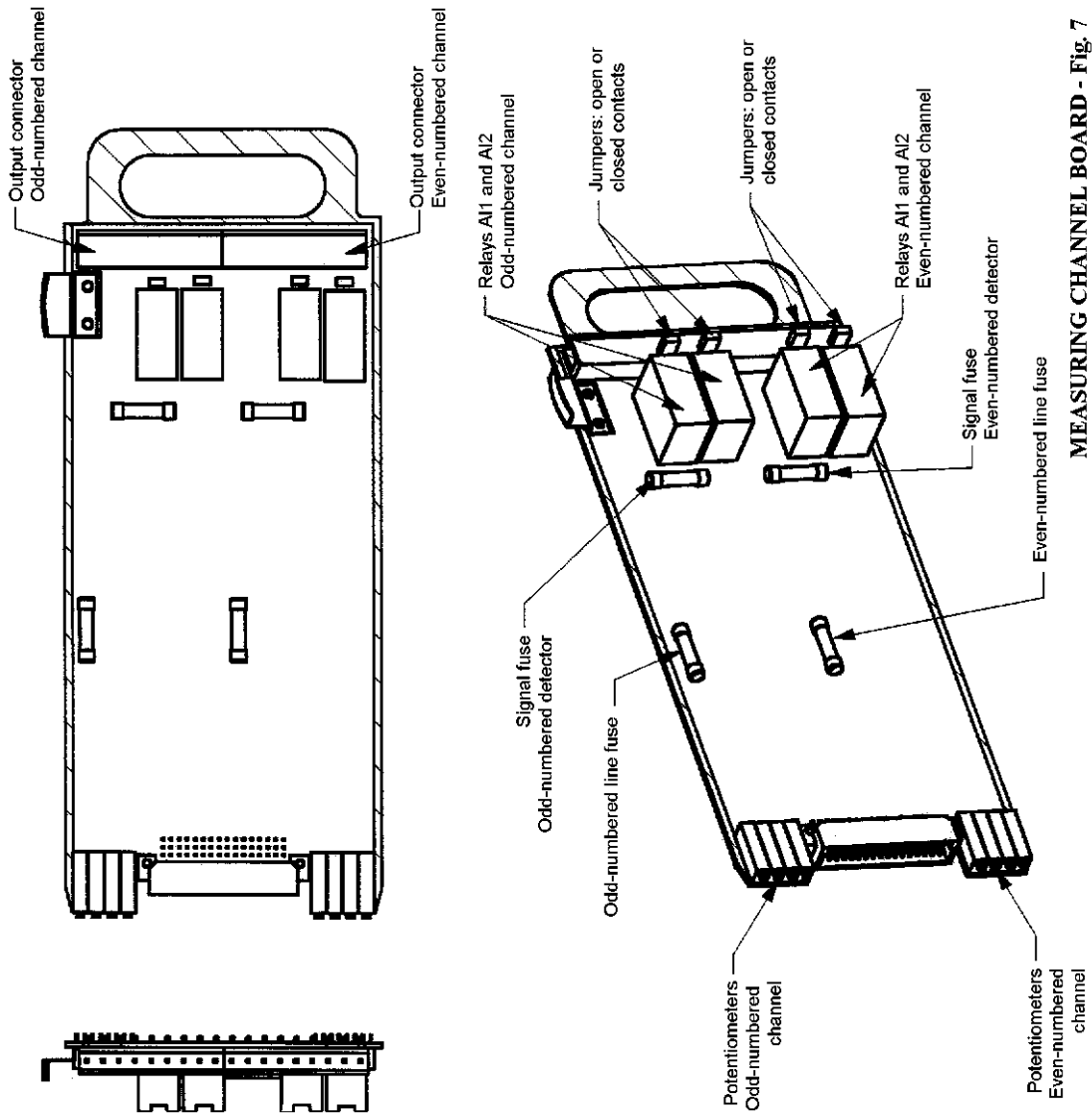

**MEASURING CHANNEL BOARD - Fig. 7**



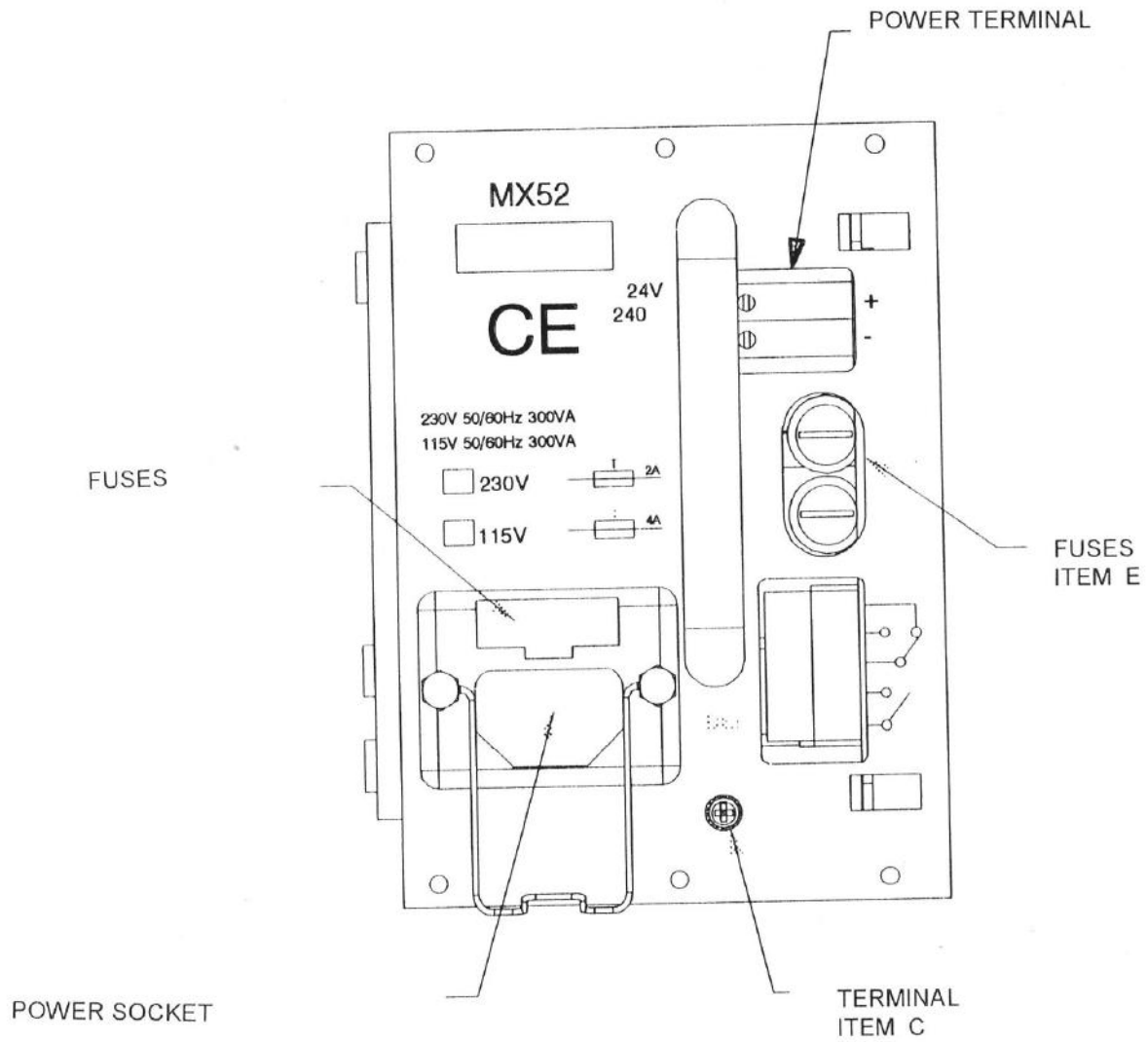

**REAR VIEW OF POWER MODULE - Fig. 8**

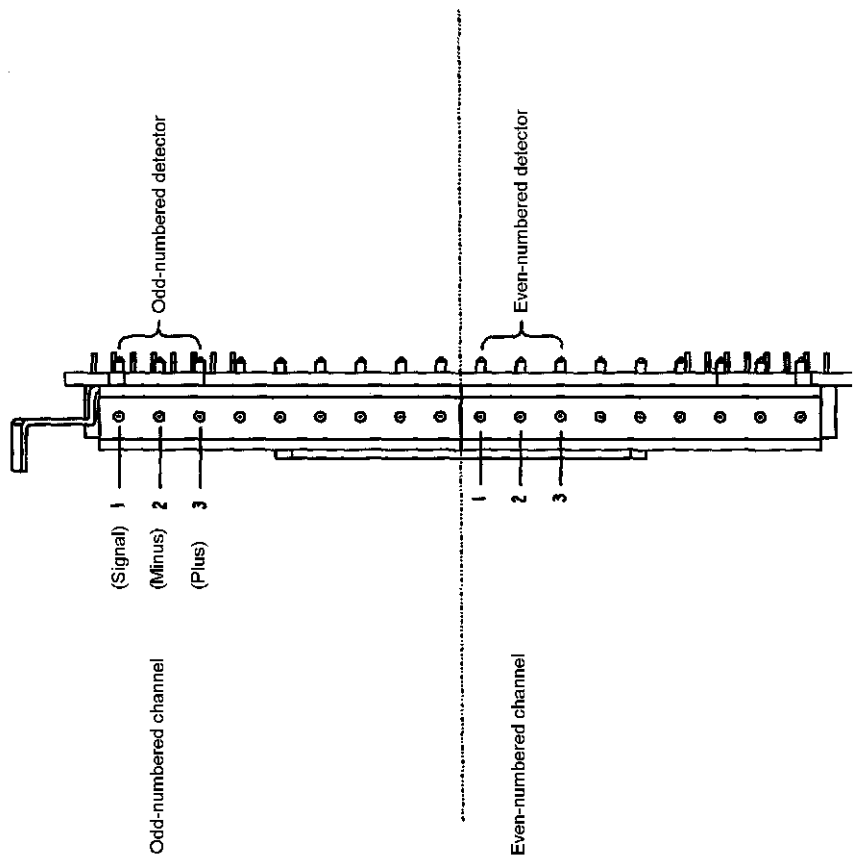

**REAR VIEW OF A MEASURING BOARD  
CONNECTIONS FOR DETECTOR - Fig. 9**

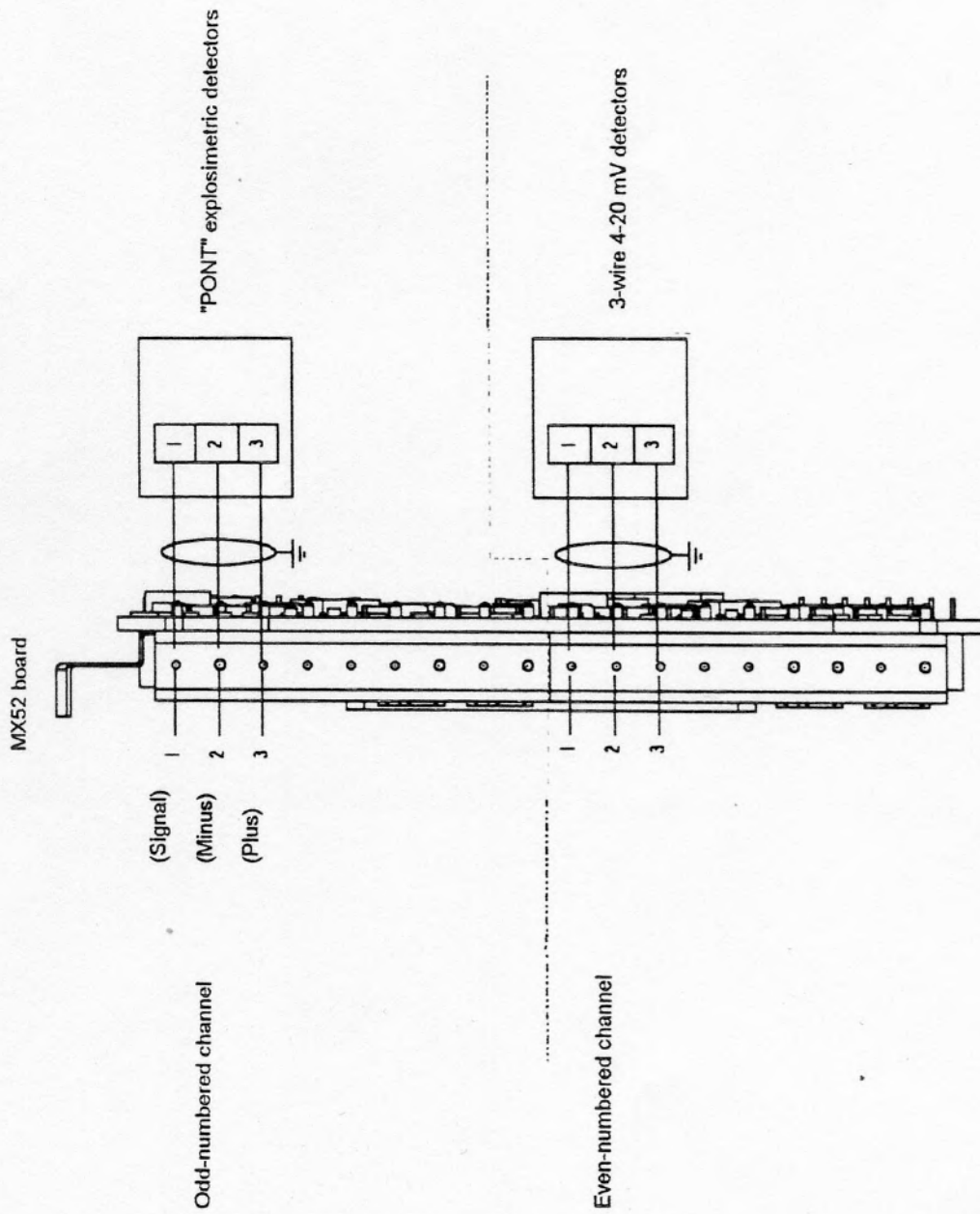

**EXAMPLE OF CONNECTION OF EXPLOSIMETRIC DETECTORS  
AND 3-WIRE 4-20 mA DETECTORS - Fig. 10**



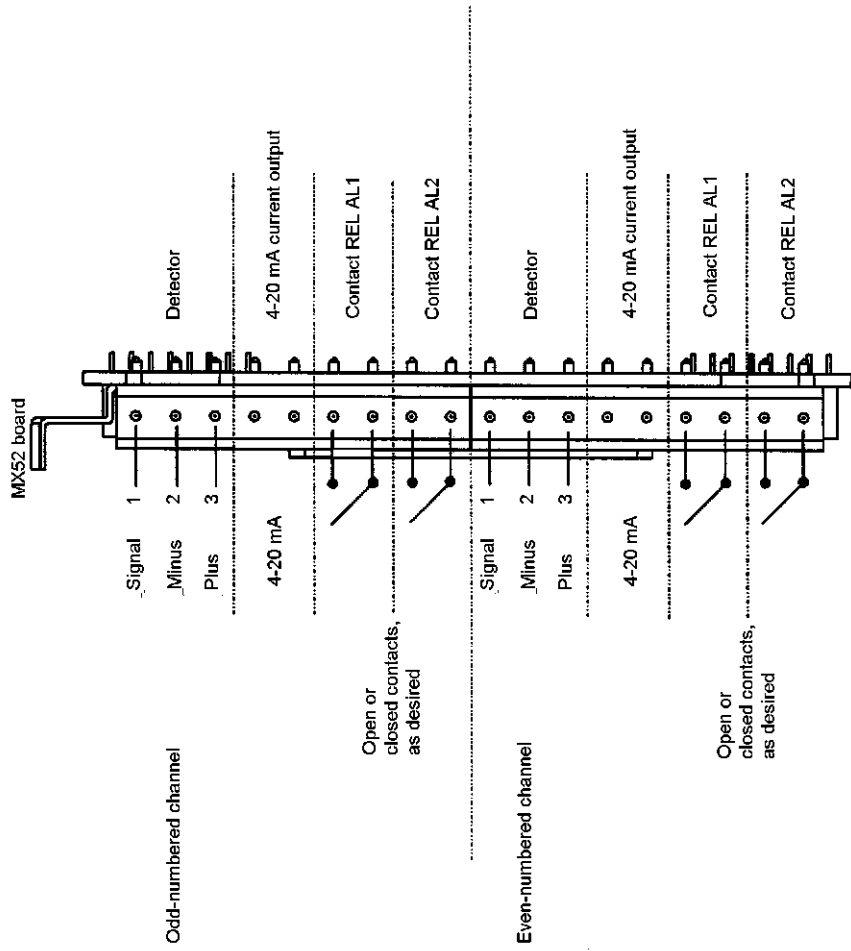

**MEASURING CHANNEL BOARD  
OUTPUTS ON REAR CONNECTOR - Fig. 12**

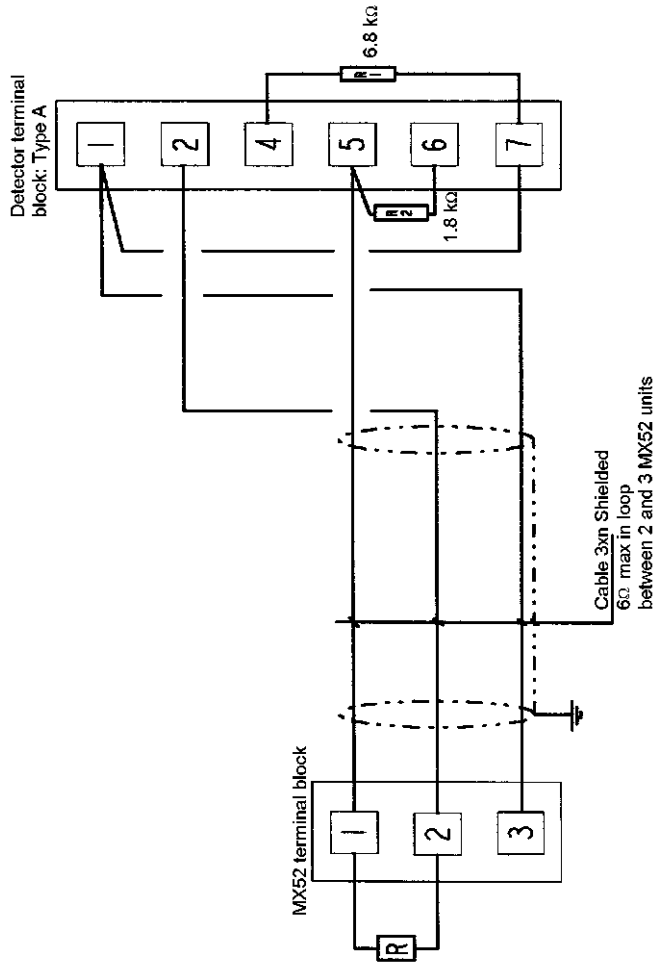

**CONNECTION OF A FLAME DETECTOR  
EQUIPPED WITH TERMINAL BLOCK OF TYPE A - Fig. 13**

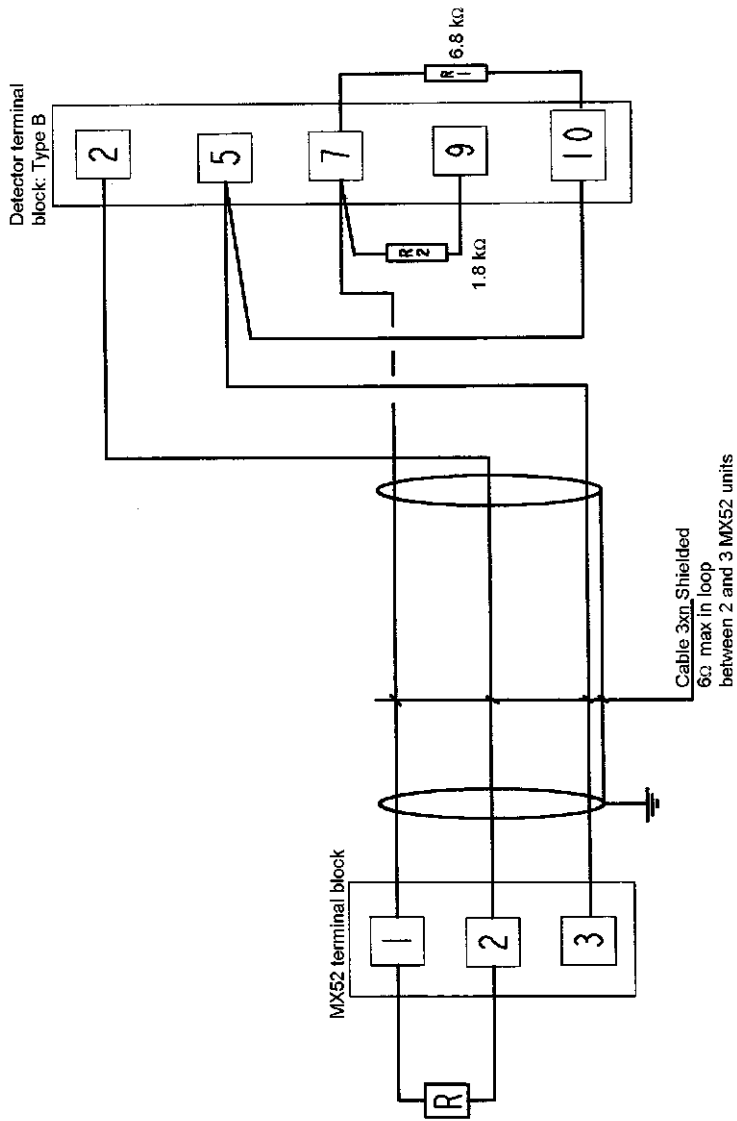

**CONNECTION OF A FLAME DETECTOR  
EQUIPPED WITH TERMINAL BLOCK OF TYPE B - Fig. 14**

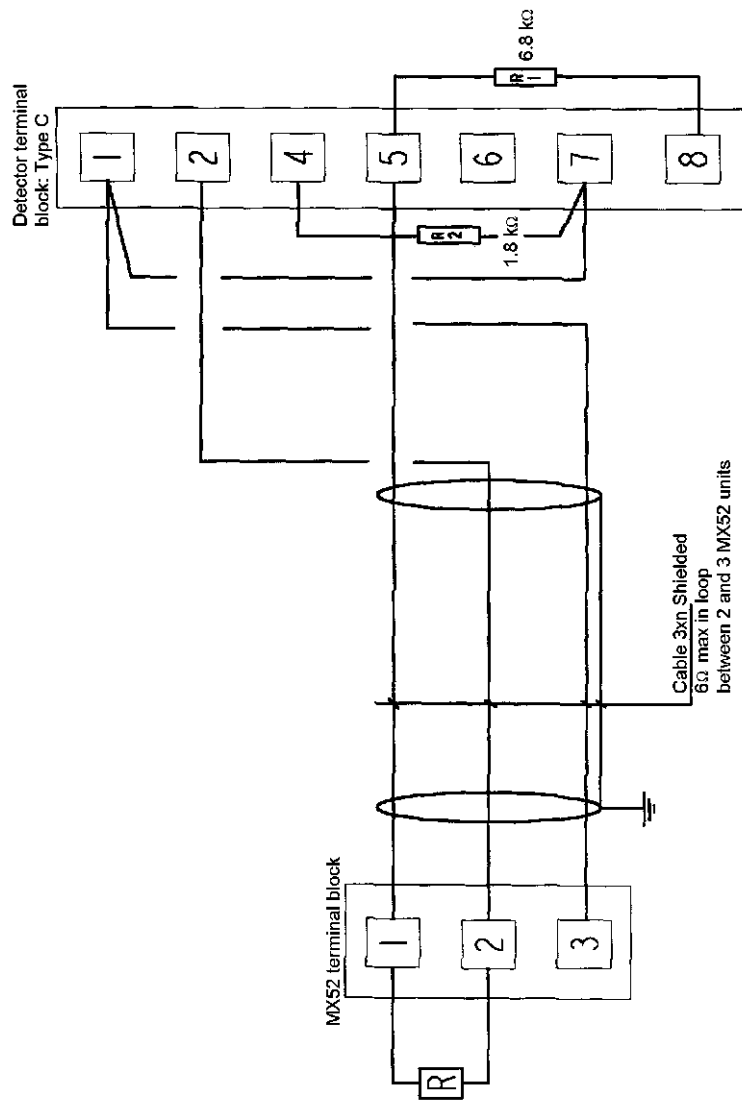

**CONNECTION OF A FLAME DETECTOR  
EQUIPPED WITH TERMINAL BLOCK OF TYPE C - Fig. 15**



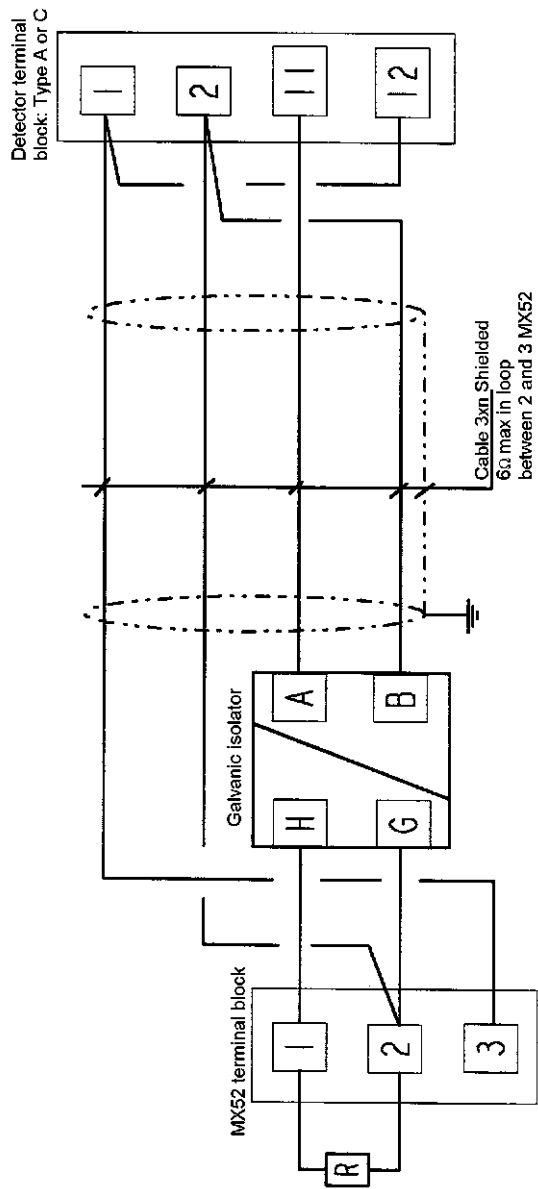

**Remark:** The detector relay can be used in local mode.  
The galvanic isolator is located in the immediate vicinity of the MX52 unit.

**EXAMPLE OF UTILIZATION OF THE 4-20 mA SIGNAL SUPPLIED BY A FLAME DETECTOR (UV / IR OR IR3) EQUIPPED WITH TERMINAL BLOCK OF TYPE A OR C - Fig. 16**

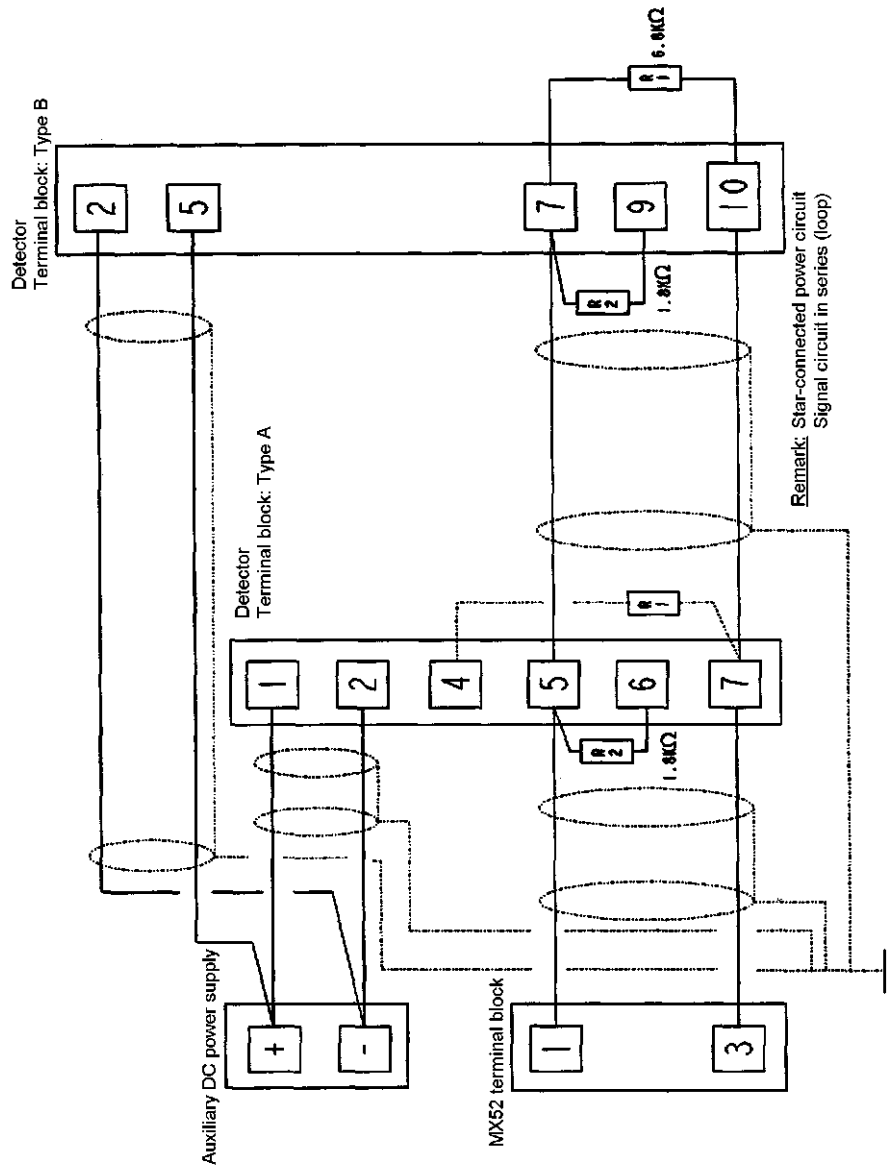

**EXAMPLE OF UTILIZATION OF FLAME DETECTORS EQUIPPED WITH EITHER CONNECTOR A OR B AND SUPPLIED WITH AUXILIARY DC POWER - Fig. 17**

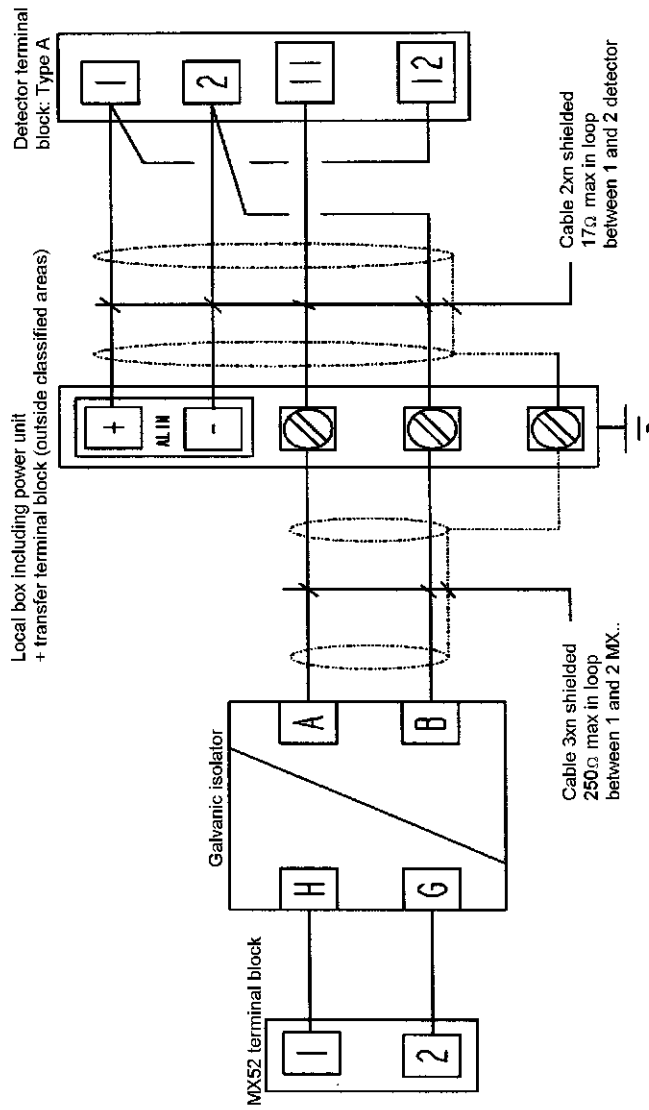

TYPICAL INSTALLATION BLOCK DIAGRAM TO BE MULTIPLIED BY NUMBER OF AREAS IN INSTALLATION

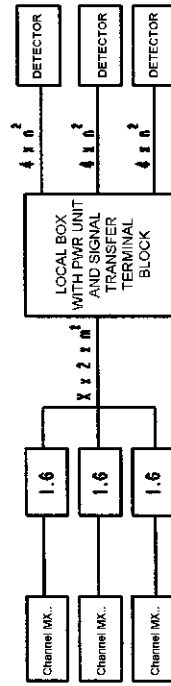

- A single detector per MX52 measuring channel
- The detector relay can be used in local mode.
- The galvanic isolator is located in the immediate vicinity of the MX52 unit.

**EXAMPLE OF UTILIZATION OF AN INTERCONNECTION BOX AND A GALVANIC ISOLATOR - Fig. 18**

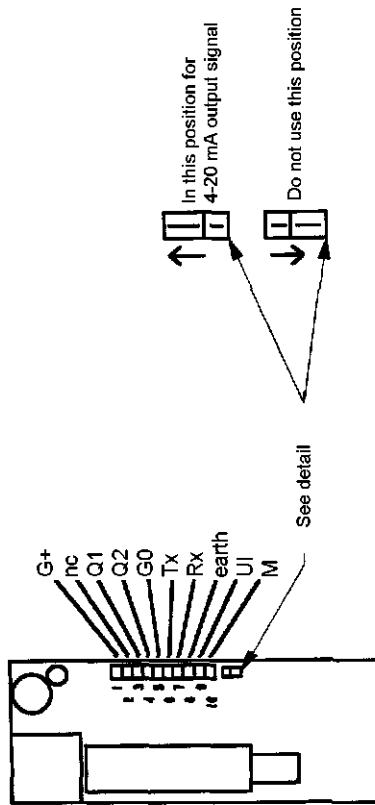
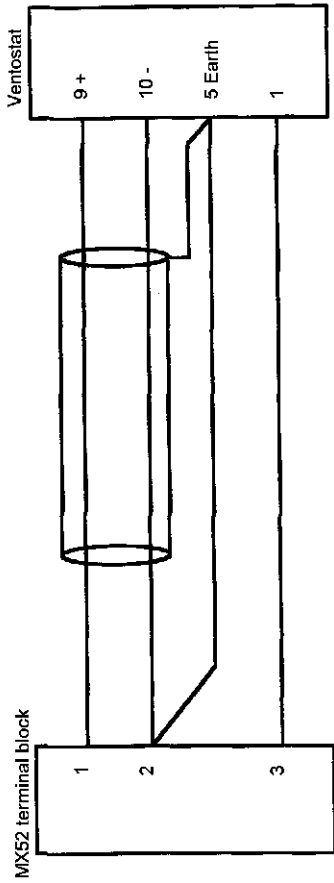

**CONNECTION OF A CO<sub>2</sub> DETECTOR  
OF VENTOSTAT 2001 TYPE - Fig. 19**

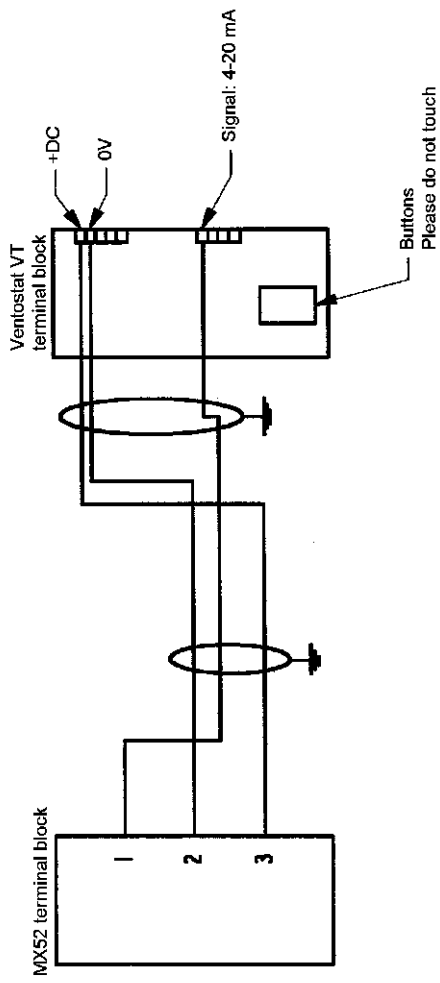

**CONNECTION OF A CO2 DETECTOR  
OF VENTOSTAT VT TYPE - Fig. 20**

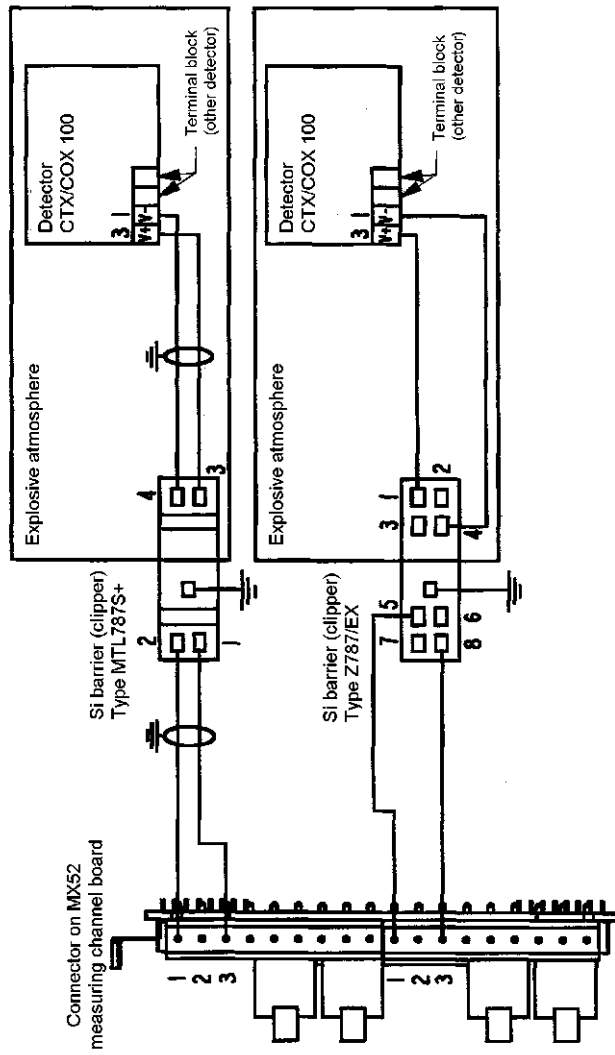

**EXAMPLES OF CONNECTION OF DETECTORS  
WITH SI BARRIERS - Fig. 21**

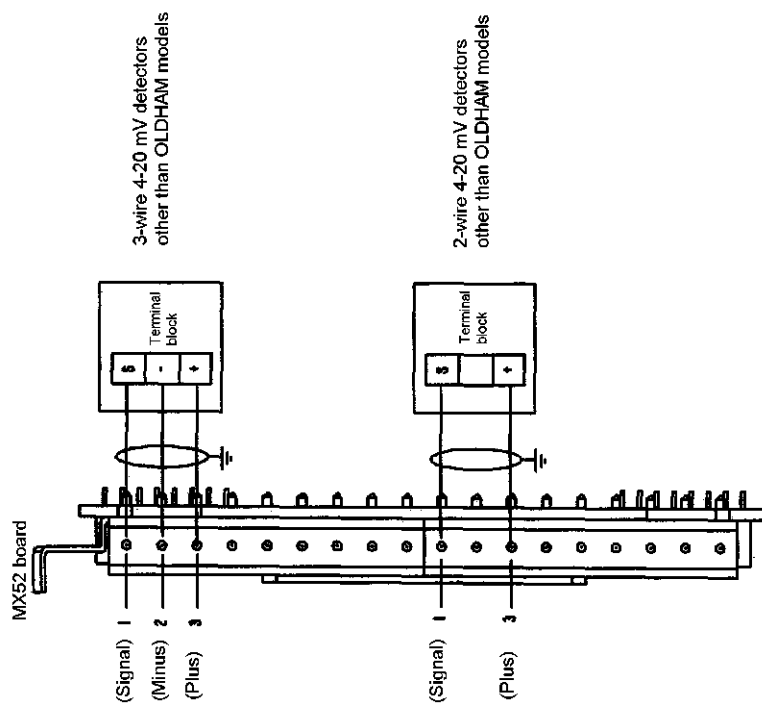

**4-20 mA DETECTORS OTHER THAN OLDHAM MODELS**  
(Power-supplied by MX52 unit) - Fig. 22

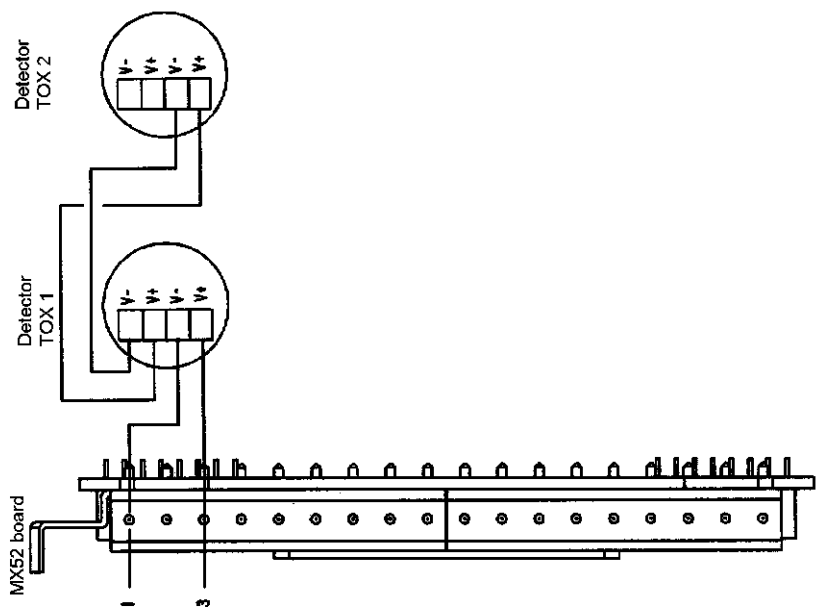



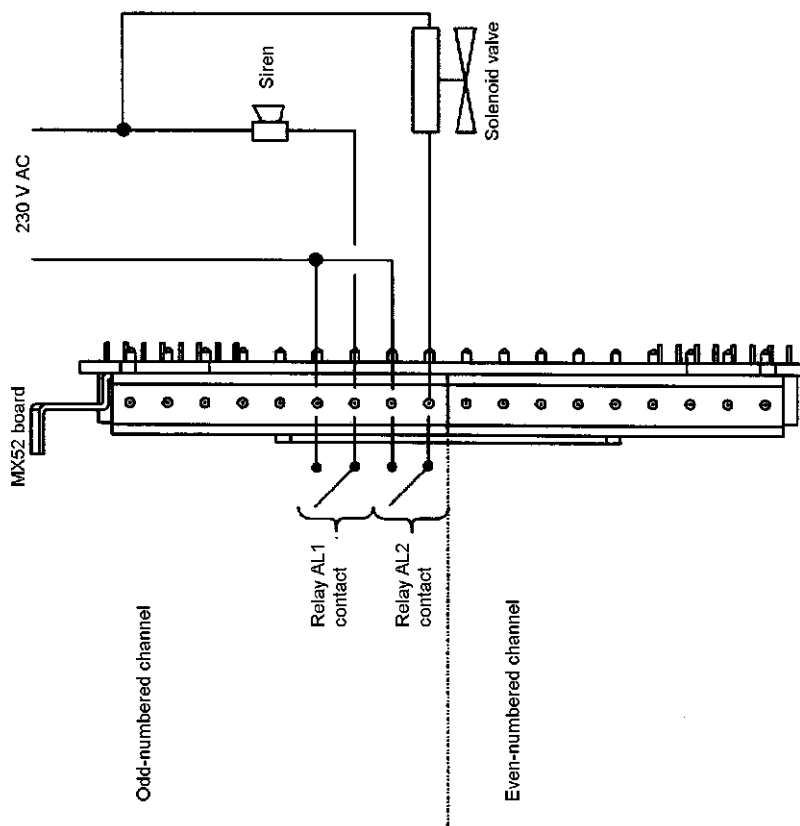

**EXAMPLE OF CONNECTION OF EXTERNAL DEVICES TO THE ALARM 1 AND 2  
RELAY CONTACTS OF A MEASURING CHANNEL - Fig. 24**

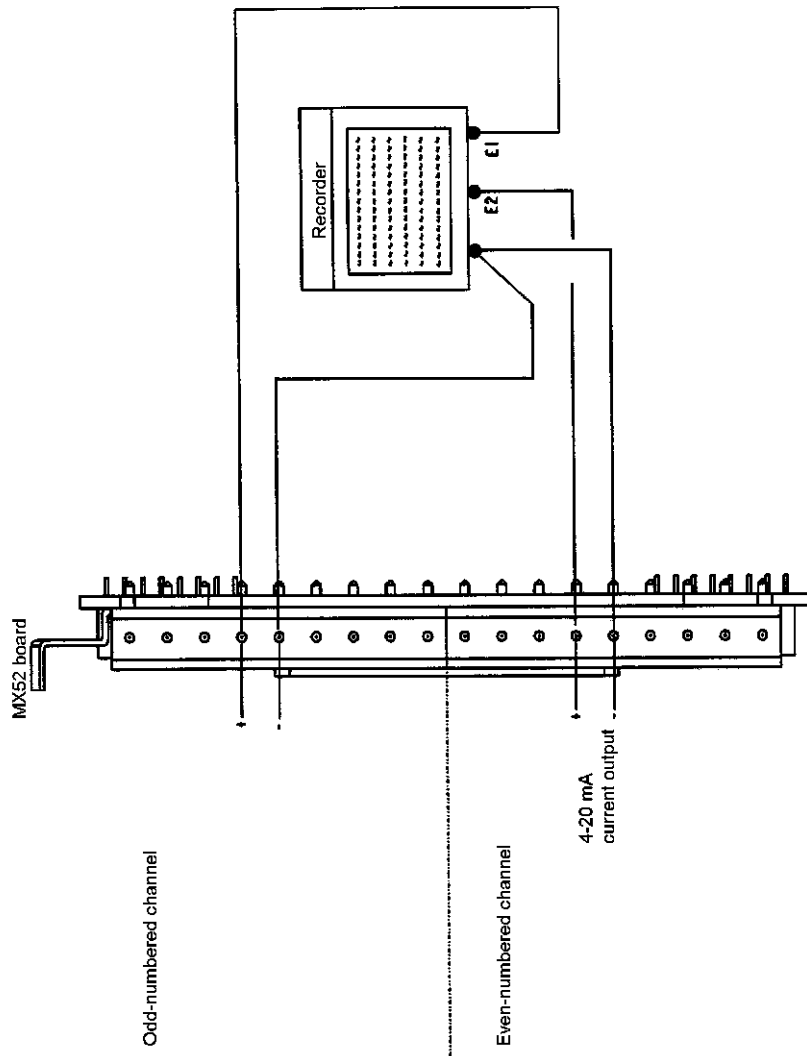

**EXAMPLE OF CONNECTION OF A RECORDER TO  
THE 4-20 mA OUTPUT OF A MEASURING CHANNEL - Fig. 25**

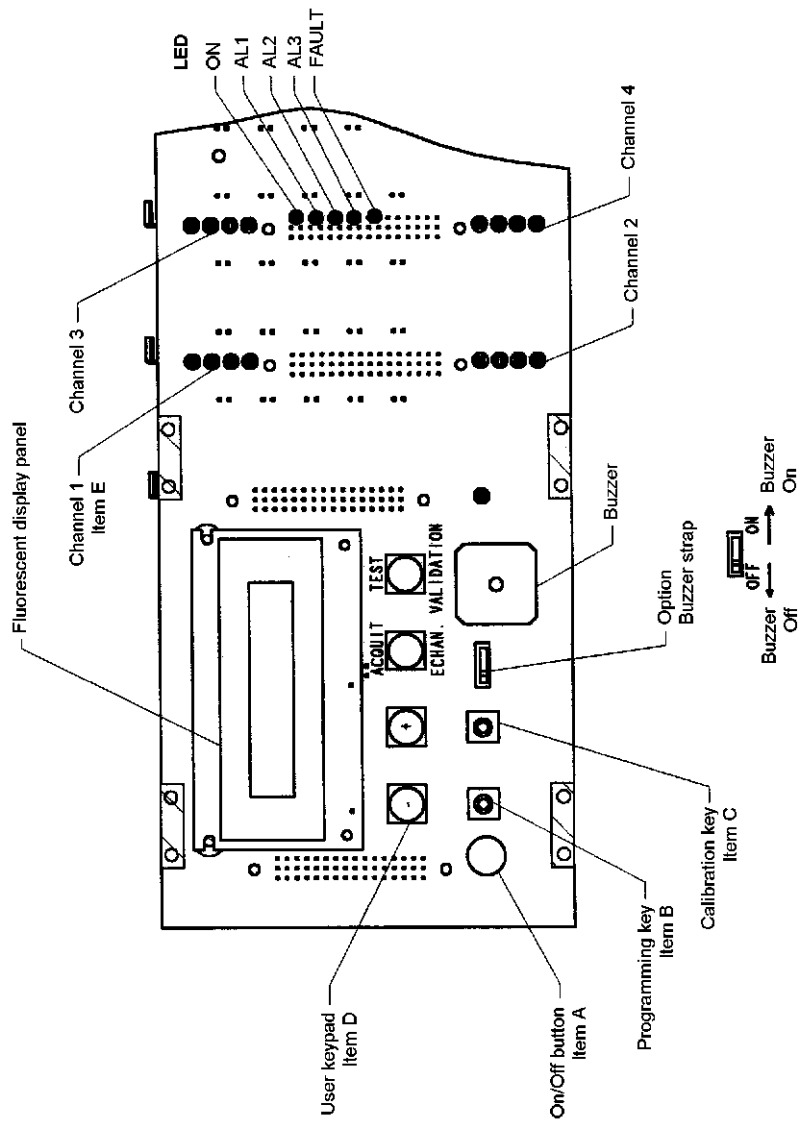

MAIN OPERATING COMPONENTS - Fig. 26

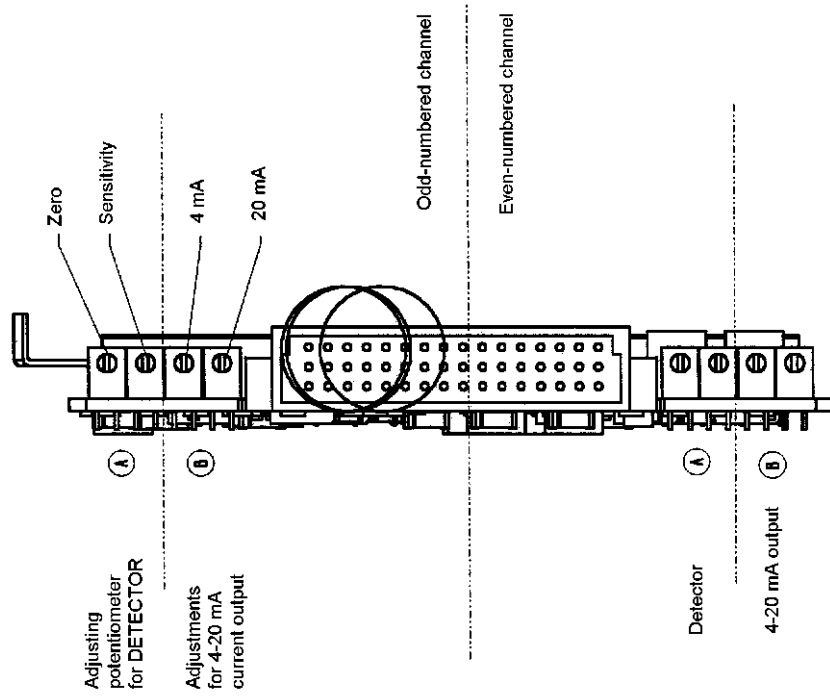

**MEASURING CHANNEL BOARD - LAYOUT OF POTENTIOMETERS ON FRONT - Fig. 27**

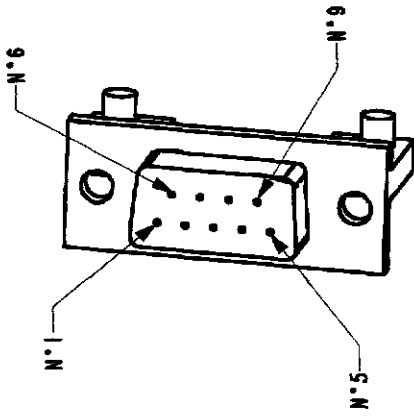

- Pin No.:
- 1: GND ISO for shielding RS485 (optional)
  - 2: TXD RS232
  - 3: RXD RS232
  - 4: RX 485/232
  - 5: GND RS232
  - 6: 485-B
  - 7: 485-A
  - 8: Do not connect
  - 9: Do not connect

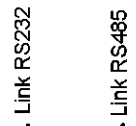

If you wish to use the RS485 link, pin 3 must be connected to pin 4.  
 For the RS232, there is no hookup.

**PINOUT OF THE MX52 SERIAL LINK CONNECTOR (ITEM A, FIG. 6) - Fig. 28**

TOP  
↑

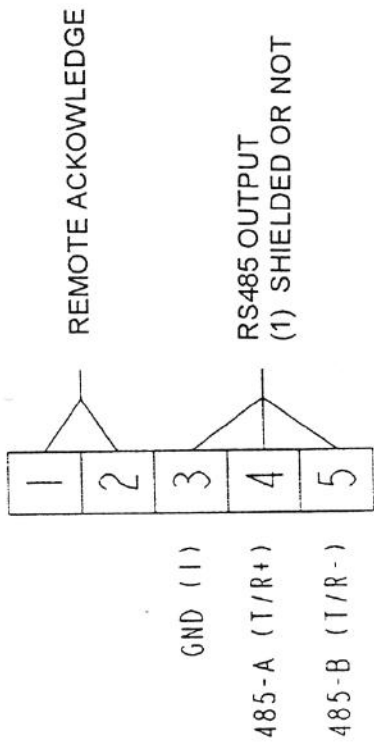

**CONNECTIONS TO THE CONNECTOR  
LOCATED BACK TO THE MX52 : FIG 29  
(on MICRO board)**

## 8. DETAILED TECHNICAL CHARACTERISTICS

---

### MANUFACTURER

OLDHAM  
62000 ARRAS - FRANCE

### BOX

- Overall dimensions: rack 3U 19"
- Function: measuring unit
- Capacity: 16 measuring channel
- Measurement: continuous
- Storage temperature: -20°C to +55°C
- Operating temperature: -10°C to +45°C
- Relative humidity: 0 to 95% humidity, no condensation

### ILLUMINATED INDICATIONS

- Fluorescent display panel, 2 lines of 16 characters
- 80 light-emitting diodes (power on, gas alarms, faults)

### POWER SUPPLIES

- 103 to 122 V AC (in option)
- 207 to 244 V AC
- 21 to 31 V DC
- Power consumptions: 300 VA or 240 W

### MEASURING INPUTS

- Active 2-wire or 3-wire shielded cables according to type of detectors
- Resistance in loop mode:
  - 3-wire EXPLO: 32  $\Omega$  (1,000 m with wire 1.5 mm<sup>2</sup> at 20°C)
  - 4-20 mA, 2-wire or 3-wire: 64  $\Omega$  (2,000 m with wire 1.5 mm<sup>2</sup> at 20°C)
  - 4-20 mA, 3-wire or 3-wire: 32  $\Omega$  (1,000 m with wire 1.5 mm<sup>2</sup> at 20°C)

## **RELAY OUTPUTS**

- 2 independent measurement alarm relays per channel
- 1 common relay for alarm 3 or audio alarm transfer
- 1 common fault relay

## **SIGNAL OUTPUTS**

- 4-20 mA analog per channel, maximum load resistance = 600  $\Omega$
- Serial: RS 485 / J BUS , common

## **MISCELLANEOUS OUTPUTS**

Alarm remote acknowledgement

## **STANDARDS**

Conformance with European standards CEM, low voltage and ATEX

CE mark



## **9. Special Specifications for use in Potentially Explosive Atmospheres in accordance with European Directive ATEX 94/9/EC.**

---

The MX52 detection device designed to measure explosive gasses and oxygen complies with the requirements of European Directive ATEX 94/9/EC on potentially explosive atmospheres.

As a result of its metrological performance, as tested by the research and testing organisation INERIS, the MX52 device, is classified as a safety device when used with OLDHAM CEX300 and OLC/OLCT 20, 40, 50 and 60 series detectors. The device may therefore contribute to limiting the risk of explosion as a consequence of the data it supplies to external units.

The information contained in the following paragraphs should be adopted and complied with by the person responsible for the site on which the equipment is installed. Please refer to the provisions of European Directive ATEX 1999/92/EC on improving health and safety conditions for workers exposed to potentially explosive atmospheres.

### **9.1. Specifications for mechanical and electrical installation in Classified Areas.**

Installation will comply with all applicable standards, and particularly with EN 60079-14, EN 60079-17 and EN 50281-1-2.

The MX52 device must not be subject to intense mechanical vibration and must be installed in a safe area away from potentially explosive atmospheres.

It is essential to refer to the user and installation manuals for the gas detectors referred to above, particularly the paragraph entitled ‘Special Specifications for use in Potentially Explosive Atmospheres in Accordance with European Directive ATEX 94/9/EC’

Where intrinsic safety installations are concerned, it should be borne in mind that the person responsible for IS installation (the “System Designer”) must draw up a system document demonstrating that every aspect of the Power Cable Detector system complies with intrinsic safety. Please refer to EN 50039 for group II and EN 50394-1 for group I when drafting this document.

### **9.2. Metrological Specifications**

The device complies with the following European standards:

#### **With explosive gas detectors:**

- European standards EN 50054 and EN 50057 for Methane (calibration gas), Propane and Hydrogen (gasses following response curves) where the device is used with CEX300 and OLC/OLCT 20, 40, 50 and 60 series gas detectors. Where the device is used with other types of sensor producing an output measurement current of 4/20 mA, these must comply with paragraph 1.5 of Appendix II of the ATEX 94/9/EC Directive and be compatible with their characteristics (cf. device transfer curve).
- European Standard EN 50271

### Oxygen detectors:

- European Standard EN 50104 where the device is used with OLCT 20, 40, 50 and 60 gas detectors. Where the device is used with other types of sensor producing an output measurement current of 4/20 mA, they must comply with paragraph 1.5 of Appendix II of the ATEX 94/9/EC Directive and be compatible with their characteristics (cf. device transfer curve).
- European Standard EN 50271

### **9.3. Connecting detectors other than OLDHAM detectors to the MX52 device**

As previously explained, users wishing to connect detectors other than those manufactured by OLDHAM, must ensure their compatibility with the device in order that the resulting combination may be considered as a safety device.

#### **9.3.1. Device transfer curves in 0% to 100% LEL configuration**

The following curve shows the response of the device in terms of value measured, and fault processing as a function of the input current value supplied by the detector. Where the user connects a brand of detector other than OLDHAM to the MX52 device, he must check carefully that the transfer curve is fully compatible with the device input characteristics, to ensure that the data generated by the detector is correctly interpreted. Equally, the device must supply a suitable power supply voltage, allowing for cable voltage losses.

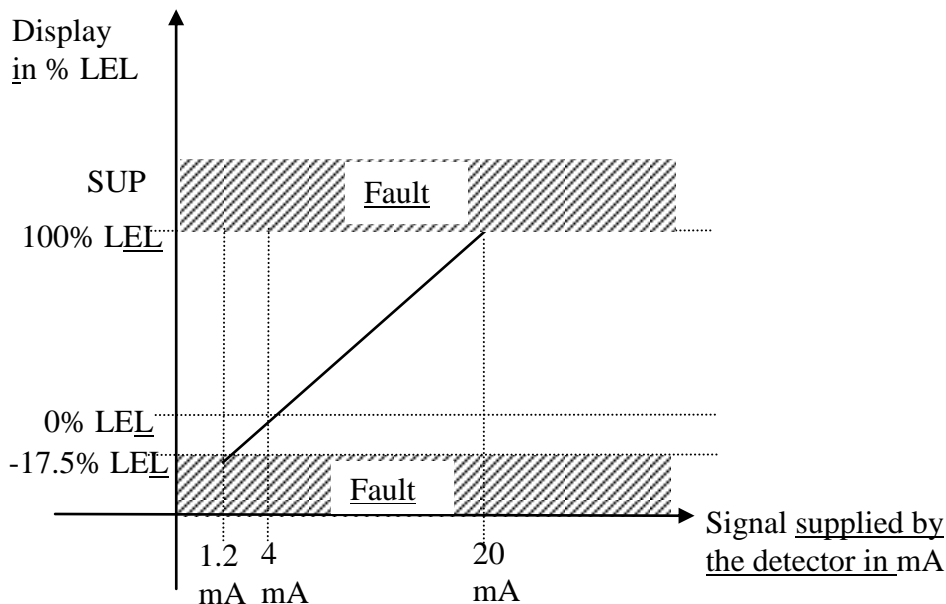

**Please note:** When the value measured is  $\geq 100\%$  LEL, the measuring device memorises the fact that the value has exceeded the scale and the channels switch to alarm and fault mode. Resetting these statuses is a manual operation to be performed by the user, who must follow the safety regulations specific to the site. The reset is checked either by turning the device on and off or by a maintenance inspection.

### **9.3.2. Device transfer curves in 0% to 30.0% OXYGEN configuration**

The following curve shows the response of the device in terms of value measured, and fault processing as a function of the input current value supplied by the detector. Where the user connects a brand of detector other than OLDHAM to the MX52 device, he must check carefully that the transfer curve is fully compatible with the device input characteristics, to ensure that the data generated by the detector is correctly interpreted. Equally, the device must supply a suitable power supply voltage, allowing for cable voltage losses.

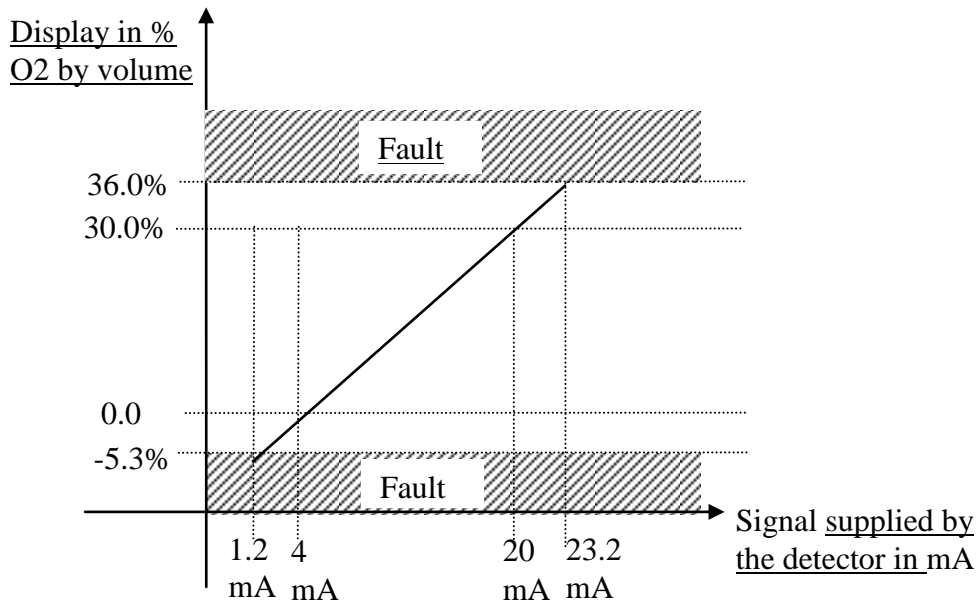

### **9.3.3. Power supply and load resistance characteristics**

Maximum current available between terminals 2 and 3: 350 mA at 21 V.

Maximum no-load voltage between terminals 2 and 3: 30 V

Load resistance (outside the IS barrier) between terminals 1 and 2: 47 ohms

N.B.: This data applies only where detectors other than OLDHAM are used. Where different types are mixed, please contact OLDHAM to establish the feasibility of the combination.

## **9.4. MARKING**

**OLDHAM**

CE 0080

Ex II 2 (G)

INERIS 04ATEX0064



La société **Oldham S.A.S.**, ZI Est 62000 Arras France, atteste que la  
**Oldham S.A.S.** company, ZI Est 62000 Arras France, declares that the

**centrale de mesure MX 52**  
***MX 52 Controller***

**reliée aux détecteurs de gaz (connected to gas detectors):**  
**CEX300, TBGW-Ex, OLC(T) IR, 20, 40, 50, 60, 100**

est conforme aux exigences des Directives Européennes suivantes :  
*complies with the requirements of the following European Directives:*

**I) Directive Européenne ATEX 2014/34/UE du 26/02/14: Atmosphères Explosives**

*The European Directive ATEX 2014/34/EU dated from 26/02/14: Explosive Atmospheres*

Normes appliquées:  
*Applied Standards*

**EN 50054, EN 50057, EN 50104**  
Performances métrologiques pour la détection des gaz  
combustibles et de l'oxygène  
*Performance requirements for combustible gases and oxygen*  
**EN 50271:01 (MX 52 Version >= V2.R16)**  
Appareils de détection de gaz utilisant un logiciel et/ou des  
technologies numériques  
*Apparatus for the detection of gases using software and/or  
digital technologies*

Note: l'équipement n'est pas impacté par les modifications majeures de la version harmonisée EN 60079-29-1  
*(the equipment is not impacted by the major changes of EN 60079-29-1)*

Catégorie (*Category*):



Attestation CE de Type du matériel:  
*EC type examination certificate*

**INERIS 04ATEX0064**

Notification Assurance Qualité de Production:  
*Notification of the Production QA*

**INERIS 00ATEXQ403**

Délivrés par l'Organisme notifié numéro 0080:  
*Issued by the Notified Body n°0080*

**INERIS, Parc Alata**  
60550 Verneuil en Halatte France

**II) Directive Européenne CEM 2014/30/UE du 26/02/14: Compatibilité Electromagnétique**

*The European Directive EMC 2014/30/UE dated from 26/02/14: Electromagnetic Compatibility*

Normes harmonisées appliquées:  
*Harmonised applied Standards*

**EN 50270:06** for type 1&2      CEM-Appareils de détection de gaz  
*EMC-apparatus for the detection of gases*

**III) Directive Européenne DBT 2014/35/UE du 26/02/14: Basse Tension**

*The European Directive LVD 2014/35/UE dated from 26/02/14: Low Voltage*

Normes harmonisées appliquées: **EN 61010-1:10**  
*Harmonised applied Standard*

Règles de sécurité pour appareils  
électriques de mesurage  
*Safety requirements for electrical  
equipment for measurement*

Arras, le 20/04/2016 (April 20<sup>th</sup>, 2016)

Michel Spellemaeker



**Oldham S.A.S.**  
Z.I. EST - C.S. 20417  
62027 ARRAS Cedex - FRANCE  
www.oldhamgas.com



Global Director of Product Management

UE\_ATEX\_MX 52\_revA



La Société Oldham S.A.S., ZI Est 62000 Arras France, atteste que la:  
(The Company Oldham S.A.S., ZI Est 62000 Arras France, declares that:)

**CENTRALE DE MESURE Type MX52**

**MX52 Gas Detection Controller**

est un **Système Instrumenté de Sécurité de niveau d'intégrité SIL 2**  
(is a **Safety Instrumented System of safety integrity level SIL 2**)

La déclaration est basée sur une analyse de fiabilité conformément à la notion de composant éprouvé par l'usage telle que décrite dans la norme EN 61511-1 Paragraphe 11.5.4.  
(The declaration is based on a reliability analysis in compliance with the concept of component proven in use as described in the standard EN61511-1 Paragraph 11.5.4)

L'analyse de fiabilité a fait de l'objet de l'Attestation INERIS n° 68210-2005 du 19 décembre 2005.  
(The reliability analysis is issued from the INERIS Examination n° 68210-2005 dated from December 2005, the 19<sup>th</sup>)

L'analyse des données de fiabilité a permis de déterminer :  
(The reliability data analysis has led to determine :)

Taux de défaillance dangereuse non détectée (undetected dangerous failure rate):	$\lambda_{du} = 0,5 \cdot 10^{-6}/h$
Proportion de défaillance en sécurité (Safe Failure Fraction) :	SFF = 93 %

Sous réserve que les relais de la centrale soient paramétrés en sécurité positive (provided the MX52 relays are energized)

Les données ci-dessus répondent aux exigences pour le niveau SIL 2 telles que définies dans les tableaux 4 et 5 de la norme EN61511-1, le mode de fonctionnement considéré pour la centrale étant le mode continu.  
(The data above comply with level SIL2 requirements as defined in table 4 and table 5 of EN61511-1 Standard, the operating mode to be considered is the continuous mode)

SIL\_MX52.ind e

Exigences pour le SIL2 – SIL 2 Requirements	
$10^{-7} /h < \lambda_{du} < 10^{-6} /h$	90 % < SFF < 99 %

Arras, le 26/09/2015

Michel Spellemaecker



Oldham S.A.S.  
Z.I. EST - C.S. 20417  
62027 ARRAS Cedex – FRANCE  
www.oldhamgas.com

Global Director of Product Management