

# KANE101

## Indoor Air Quality Analyser



Stock No: 20103

October 2018

© Kane International Ltd

# CONTENTS

	Page
KANE101 OVERVIEW	4-5
1. ANALYSER LAYOUT & FEATURES	6
2. BATTERIES	7-8
3. BEFORE USING THE ANALYSER FOR THE FIRST TIME	8
4. BEFORE USING THE ANALYSER EVERY TIME	8
5. USING THE ANALYSER AND ITS FOUR BUTTONS	10-11
6. USING THE ROTARY DIAL (starting from Menu)	12-23
6.1 MENU	12-15
6.2 STATUS	16
6.3 AUX	16
6.4 AMBIENT CO <sub>2</sub> & CO	17
6.5 IAQ	17
6.6 TIMED LOG	18
6.7 ROOM TEST	19-23
7. MEASURING GASES	24
8. EXAMPLE PRINTOUT IN AMBIENT AIR	25
9. WHEN YOU FINISH USING THE ANALYSER	26
10. MAINTENANCE	27-28
10.1 EMPTYING & CLEANING THE INTEGRAL WATER TRAP	27
10.2 CHANGING THE PARTICLE FILTER	28
11. PROBLEM SOLVING	29
12. KANE DASHBOARD	30-31
13. ONLINE BOOKING PROCEDURE	32-34

14. ANALYSER ANNUAL SERVICE & RECERTIFY	35-38
14.1 SERVICE-CALIBRATE-RECERTIFY	35-36
14.2 RETURNING YOUR ANALYSER TO KANE	37
14.3 WHERE TO SEND YOUR ANALYSER	38
15. COLD WEATHER PRECAUTIONS	38
16. SPECIFICATION	39
17. ELECTROMAGNETIC COMPATIBILITY	40
APPENDIX	41
PRODUCT REGISTRATION	43-44

# KANE101 OVERVIEW

The KANE101 tests for ambient CO and ambient CO<sub>2</sub> concentrations. Optionally it will also measure ozone and with an external wand temperature, humidity and airflow

The large display shows 6 lines of data which can be printed via an optional infrared printer. The printed data can be 'live' data or 'stored data'. Data can also be transferred wireless to an Android Printer App or KANE LIVE software.

The KANE101 is controlled using 4 buttons and a rotary dial.

The four buttons (from left to right)



switch the instrument on and off, or temporarily hold or 'freeze' the current reading.



print actual or saved data, switch the backlight on and off,



switch the pump on and off



save data



= Scroll up



= Scroll  
down

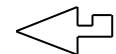

= Enter

The buttons with  $\triangle$ ,  $\nabla$  and  $\leftarrow$  also change settings such as date, time, when in menu mode.

The KANE101 can store up to 142 store locations – 40 AUX, 40 Ambient CO<sub>2</sub>/CO, 40 IAQ, 2 Timed Logs up to 240 tests and 20 Room test.

The KANE101 is powered by internal re-chargeable NiMH batteries. The internal battery will power the analyser for about 6Hr, from full charge.

The KANE101 has a protective rubber sleeve with a magnet for “hands-free” operation.

**NOTE:** Fresh air is referred to in this manual. Sometimes it may be convenient to use thin flexible tubing (min ID. 3mm.) to supply fresh outside air, if a tube is used ensure that the inlet is at least 1 meter away from any possible source of CO<sub>2</sub> such as an open window.

Fuel combustion of any sort may cause high and fluctuating levels of CO<sub>2</sub> over surprisingly large areas. Exhaled breath can easily reach 20,000ppm.

**The air in a sealed room is not really fresh so it is really important to use outside fresh air away from flues, car exhausts etc**

# 1. ANALYSER LAYOUT & FEATURES

## INSTRUMENT FEATURES AND KEYPAD



**ON / OFF**  
Turns analyser ON and OFF



Scroll key when using the Menu  
**PUMP**  
Turns pump ON and OFF



Scroll key when using the Menu  
**PRINT / BACKLIGHT**  
Print 'live' or stored data  
Turns on Backlight



Enter key when using the Menu  
**STORE**  
Stores readings in the Memory

## 2. BATTERIES

### Battery Type

This analyser has been designed for use with disposable alkaline batteries or rechargeable Nickel Metal Hydride (NiMH) batteries. No other battery types are recommended.



### **WARNING**

**The battery charger unit must only be used when NiMH batteries are fitted. Do not mix NiMH cells of different capacities or from different manufacturers. All four cells must be identical**

### Replacing Batteries

Turn over the analyser, remove its protective rubber cover and fit 4 “AA” batteries in the battery compartment. **Take great care to ensure they are fitted with the correct battery polarity.** Replace the battery cover and protective rubber cover.

Switch the analyser on and check that the analyser’s time and date are correct. To reset see **USING THE MENU, Section 5.**

### Charging NiMH Batteries

Ensure that you use the correct charger. The part number is 19278.

To fully charge NiMH batteries:

The charger must be connected and switched on.

When charging, the red Battery Charging Indicator will illuminate.

After a few seconds, the display will show “ CHARGING BATTERY” if they need extra charge.

The first charge should be for 12 hours continuously. NiMH batteries are suitable for top up charging at any time, even for short periods.

An in-vehicle charger can be used to top up the analyser's batteries from a 12 volt vehicle battery. The part number is 18342.

## **Battery Disposal**

Always dispose of depleted batteries using approved disposal methods that protect the environment

### **3. BEFORE USING THE ANALYSER FOR THE FIRST TIME:**

Set the correct time, date etc, after it is switched on and calibrated – See **USING THE ROTARY DIAL** below. These are stored when the analyser is switched off.

### **4. BEFORE USING THE ANALYSER EVERY TIME:**

Check the water trap is empty and the particle filter is not dirty:

- To empty the water trap, unscrew its red stopper and re-screw once it is empty.
- To change the filter, remove protective rubber sleeve, pull out the water trap , remove the water trap's particle filter from the spigot and replace. Reconnect the water trap and rubber protective sleeve.

**Remember to always switch on in outside fresh air.**

After switch on check that date and time are correct and battery power is sufficient.

Avoid exposing the instrument to sudden large temperature changes, and ensure that the unit reads zero for CO and approx. 400 ppm CO<sub>2</sub> in fresh outside air before use. If necessary re-zero.



## **SAFETY WARNING**













This analyser can be used to extract combustion gases that may be toxic in relatively low concentrations. These gases are exhausted from the back of the instrument. **This analyser must only be used in well-ventilated locations by trained and competent persons after due consideration of all the potential hazards.**





**It is recommended that the analyser is switched on in outside fresh air so that the levels of CO when entering a premise can be measured and any potential danger can be spotted.**

Users of portable gas detectors are recommended to conduct a “bump” check before relying on the unit to verify an atmosphere is free from hazard.

A “bump” test is a means of verifying that an instrument is working within acceptable limits by briefly exposing to a known gas mixture formulated to change the output of all the sensors present. (This is different from a calibration where the instrument is also exposed to a known gas mixture but is allowed to settle to a steady figure and the reading adjusted to the stated gas concentration of the test gas).

## 5. USING THE ANALYSER AND ITS FOUR BUTTONS:

<p>Switching ON the analyser</p> <p>Or HOLD the readings</p>	<p>Press the  button to switch the unit ON <b><u>outside in fresh air</u></b>. This allows the analyser's sensors to be calibrated. This will set CO to zero and CO<sub>2</sub> to around 400 ppm .</p> <p>At switch on, the analyser beeps four times and displays the model number. The bottom line counts down from typically 90 seconds.</p> <p>When the analyser is running in measurement mode a quick press of this key will HOLD the reading. Another quick press will release the readings.</p>
<p>Switching OFF the analyser</p>	<p>Press the  button to switch the analyser OFF. The display counts down from 30 with the pump on to allow time for the sensors to be cleaned or purged with fresh air. If the probe is connected, make sure both analyser and probe are in fresh air.</p> <p>Press  /  if you want to stop the count-down to off and return to making measurements.</p>
<p>Using  /  /  Buttons</p>	<p>Once the "on" countdown has been completed:</p> <p>Use the  /  /  keys to change settings (such as time and date ) when the rotary dial is turned to MENU.</p>
<p>Use the   key</p>	<p>Press to save readings if memory locations are available.</p> <p>The display will flash LOG xxx (or FULL) to give the store location of the saved data.</p>











<p>Switching on and off the backlight.</p>	<p>Press  for about 2 sec. and release to switch backlight on or off.</p> <p>Note: use of the backlight increases the drain on the battery.</p>
<p>Printing Data</p>	<p>Press  to start the analyser printing. The analyser displays "PRINTING" until this is completed.</p> <p>Make sure the printer is switched on, ready to accept data and its infrared receiver is in line with the emitter on top of the analyser.</p>
<p>Switching PUMP on / off</p>	<p>The analyser normally operates with the pump on. Press  to switch the pump off and on.</p> <p>When the pump is switched off, the analyser displays "PUMP OFF" approx every 20 seconds.</p>
<p>"Freezing" the display</p>	<p>Press  to freeze all readings. The display flashes and can be printed by pressing the PRINT key. Press again for "live" measurements.</p>



## 6. USING THE ROTARY DIAL (starting from Menu):

Rotor positions are:

- **Menu** the MENU options are listed below
- **Status** display time, date, time ambient temp, days before CAL due, battery level .
- **Aux** 6 lines of user defined parameters
- **Amb CO + CO2** displays CO and CO<sub>2</sub> reading in ppm with average and .... max.
- **IAQ** 6 measured values
- **Timed Log** user selected logging periods 1 to 24 hours
- **Room Test structured Room testing**

### 6.1 MENU SELECTION .

MENU	<p>Rotate the dial to MENU and use the ,  and  buttons as described fully below to select and change the following functions:</p> <ol style="list-style-type: none"> <li>1.SETUP</li> <li>2. ALARMS</li> <li>3. SCREEN</li> <li>4. REPORT</li> <li>5. SERVICE</li> </ol> <p><u>Using ,  and  keys.</u></p> <p>When you have selected the function to change, press  to select.</p> <p>Repeat this to scroll through the menu and select (using the ) and change (using the  /  keys) the function.</p>
------	---

	<p>The final, logical  returns you to the main display.</p> <p>To exit the Menu function at any time, rotate the dial to another position - Unless the final logical  is pressed, no changes are made.</p>
--	---

## SETUP

Language	Select language
Set Time	Set current time
Set Date	Set date format and current date.
Printer	Choose KM IRP, KANE IRP-2, SERIAL or WIRELESS
Passkey	Default is 1 1 1 1
Pump flow	Set flow rate 1 to 4.
Gas	ppm or mg/m3
Temp	C or F
Readings	Clear all readings from memory
Back	

## ALARMS

CO set	Turn alarm on or off
CO level	Set alarm level in ppm
CO2 set	Turn alarm on or off
CO2 level	Set alarm level in ppm
BACK	

## SCREEN

Contrast	Adjust screen contrast. Default = 14
Backlight	Adjust backlight switch off time 0 to 300 secs
AUX	Choose which parameter to display on the 6 lines of the screen
Back	

## REPORT

AUX	View or delete
AMBIENT	View or delete
IAQ	View or delete
TIMED LOG	View or delete
ROOM TEST	View or delete
HEADER	Set Line 1 and Line 2 of the printed header
BACK	

## SERVICE

Reserved for approved service agents.

## REPORT Functions

With the rotor pointing to MENU use the  $\triangle$  /  $\nabla$  keys to select REPORT and press 

The  $\triangle$  /  $\nabla$  keys can then be use to select which report you want to view.

Press ENTER to make a selection.

Use ENTER to toggle the change mode. With the side pointer flashing you can use UP/DOWN to change that line's display.

When the side pointers are not flashing the UP/DOWN keys change the line to be worked on.

## VIEW

**The top line** displays the LOG No

Use  $\triangle$  /  $\nabla$  to select next view number (within the range of data stored up to 142 maximum – 40 AUX, 40 Ambient CO2/CO, 40 IAQ, 2 Timed Logs and 20 Room Test)

**The second line** displays the LOG time and DATE.  
With the side pointer flashing you can toggle between date and time.

**Lines 3 4 and 5** display stored measurement.  
With the side pointers flashing on any of these lines you can scroll through all the measured parameters

The bottom line displays PRINT.  
Scroll down to this line to print the stored data

## 6.2 STATUS

### STATUS DISPLAY

Select "Status" on the dial to view the following:

<b>14:56:29</b>	→	Current time. Can be re-set via the "Menu"
<b>11/03/06</b>	→	Current date. Can be re-set via the "Menu"
<b>Ta      23.8C</b>	→	Ambient temperature of the analyser
<b>CAL      283</b>	→	Shows number of days until next calibration is due
<b>BAT      </b>	→	Shows the charge level of the batteries

## 6.3 AUX

This is a user defined display.

### Typical AUX display

<b>FLOW    0.0m</b>	→	The AUX (auxillary) display can be customised via MENU / SCREEN / AUX.
<b>R H      35%</b>	→	The parameters displayed on lines 1, 2, 3, 4, 5 and 6 can be set by the user.
<b>CO      52p</b>	→	They remain the AUX parameters until changed by the user.
<b>CO2    1234p</b>		
<b>Ta      22.4C</b>		
<b>ExT    35.2C</b>		

The displayed parameters are set by the user using a MENU function. These setting are then retained.



## 6.4 AMB CO2 + CO

<b>CO</b>	<b>0p</b>	→ Current CO reading
<b>CO2</b>	<b>1234p</b>	→ Current CO2 reading
<b>COa</b>	<b>52p</b>	→ Average CO reading
<b>CO2a</b>	<b>945p</b>	→ Average CO2 reading
<b>COm</b>	<b>88p</b>	→ Maximum CO reading
<b>CO2m</b>	<b>3456p</b>	→ Maximum CO2 reading

These instantaneous readings can be held, stored or printed.

## 6.5 IAQ

<b>CO</b>	<b>35p</b>	→ Measured CO reading
<b>CO2</b>	<b>1234p</b>	→ Measured CO <sub>2</sub> reading
<b>Ta</b>	<b>25.2C</b>	→ Ambient temp.
<b>ExT</b>	<b>32.2C</b>	→ Wand temperature
<b>RH</b>	<b>88.7%</b>	→ Wand relative humidity %
<b>FLOW</b>	<b>1.1m</b>	→ Wand airflow reading

External temperature, relative humidity and airflow are only available with the use of the optional wand.

OZONE measurement is only available as an option if specified at the time of purchase.

## 6.6 TIMED LOG

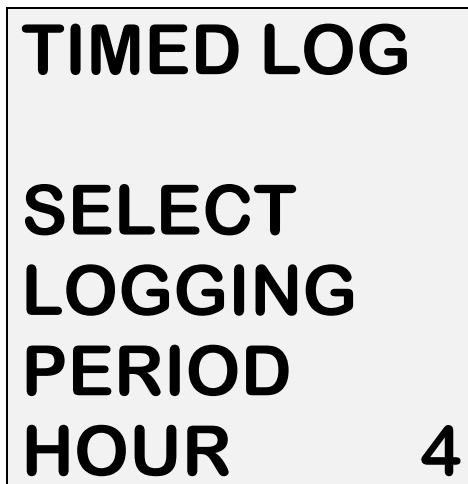

Logging period can be adjusted from 1 hour up to 24 hours.

240 measurements are stored.



Only two sets of 240 measurements are retained in memory.

Always ensure that there is enough charge in the batteries to cover the full test time or plug in the battery charger.

## 6.7 ROOM TEST

Select "Room Test" to measure and record CO and CO<sub>2</sub> readings for up to 30 minutes.

**SELECT  
ROOM TEST  
TEST TYPE  
GENERAL**

→ Use  /  to select the test type from the following:

### TEST TYPES

GENERAL:	15 minute test with results stored every minute	LIMIT = 10ppm ALARM = 30ppm
USER TYPE:	Parameters are set by the user	
SWEEP TEST:	2 minute test with max reading stored at end	LIMIT = 10ppm ALARM = 30ppm
MIGRATION TEST:	15 minute test with results stored every minute	LIMIT = 10ppm ALARM = 30ppm
TYPE C SEALED APPLIANCE:	15 minute test with results stored every minute	LIMIT = 10ppm ALARM = 30ppm

TYPE B BOILER OPEN FLUE: 15 minute test with results stored every minute LIMIT = 10ppm ALARM = 30ppm

TYPE A COOKER: 30 minute test with results stored every minute LIMIT = 30ppm ALARM = 90ppm

TYPE A WATER HEATER: 5 minute test with results stored every minute LIMIT = 10ppm ALARM = 30ppm

TYPE A SPACE HEATER: 30 minute test with results stored every 1 minute LIMIT = 10ppm ALARM = 30ppm

### Typical ROOM TEST display

<b>ROOM TEST</b>	<b>1/30</b>	→ Test progress (Test 1 of 30)
<b>INT</b>	<b>40s</b>	→ Test countdown
<b>CO2</b>	<b>1234p</b>	→ Measured CO2
<b>CO</b>	<b>0p</b>	→ Measured CO
<b>Limit</b>	<b>10p</b>	→ CO limit for this test

The user can stop the Room test at any time by pressing PRINT

If not stopped earlier, the Room test will automatically end after the designated time.

The Room test series is automatically stored in the memory as a log number.

When completed the log can be printed immediately by pressing  .



At the end of the test the display shows:

<b>LOG No.</b>	<b>4</b>
<b>08:49:51</b>	
<b>TEST</b>	<b>1</b>
<b>CO</b>	<b>2p</b>
<b>CO2</b>	<b>1234p</b>
<b>PRINT</b>	<b>↓</b>



### Viewing / printing a logged Room test

Select MENU / REPORT / ROOM / VIEW

When LEDs are not flashing

Use the  /  keys to change line on the display

Press  to cause the LEDs on that line to flash.

With the LEDs flashing, press  /  to allow the parameter on that line to be changed.



Press  to select that change.

The LEDs stop flashing and  / 

Use  /  to change the line again.



<b>LOG No.</b>	<b>2</b>
<b>07:49:51</b>	
<b>TEST</b>	<b>1</b>
<b>CO</b>	<b>12p</b>
<b>CO2</b>	<b>2234p</b>
<b>PRINT</b>	<b>↓</b>



With no LEDs flashing

Use the  /  keys to move the lit LEDs to the line you want.

You can change the LOG number and the TEST number so that you can view individual test results.

Press  to select the line you want and the LEDs will start to flash.

Now use the  /  keys to change the number (the TEST number or the LOG number)

Press  when you are happy with the changes. The LEDs will stop flashing. Now use the  /  keys to move the LEDs to the PRINT line.

Sending to the printer or wireless device will only occur when you move the LEDs to the print line and press 

Press  to print the test, (or send to PC via optional Wireless module).

# ROOM TEST TYPICAL PRINTOUTS

KANE101 SW19477 V1.00  
 YOUR COMPANY NAME &  
 PHONE NUMBER HERE  
 SERIAL No. 052718005  
 LOG No. 03  
 DATE 21/08/18  
 TIME 08:12:02  
 -----  
 CAL DUE ON 01/08/19  
 -----  
 ROOM TEST  
 -----  
 GENERAL  
 LIMIT 10ppm  
 ALARM 30ppm  
 TESTS 15  
 -----  

TEST	CO ppm	CO2 ppm
01	0	522
02	0	455
03	0	460
04	0	459
05	0	460
06	0	468
07	0	458
08	0	467
09	0	464
10	0	462
11	0	471
12	0	471
13	0	478
14	0	475
15	0	481
MAXIMUM	0	522

 -----  
 CUSTOMER  
 .....  
 .  
 .  
 .....  
 APPLIANCE  
 .....  
 .  
 .  
 .....  
 REFERENCE  
 .....  
 .  
 .  
 .....

KANE101 SW19477 V1.00  
 YOUR COMPANY NAME &  
 PHONE NUMBER HERE  
 SERIAL No. 052718005  
 LOG No. 04  
 DATE 21/08/18  
 TIME 08:30:21  
 -----  
 CAL DUE ON 01/08/19  
 -----  
 ROOM TEST  
 -----  
 TYPE A  
 SPACE  
 HEATER  
 LIMIT 10ppm  
 ALARM 30ppm  
 TESTS 30  
 -----  

TEST	CO ppm	CO2 ppm
01	0	481
02	0	483
03	0	495
04	0	483
05	0	484
06	0	482
07	0	476
08	0	479
09	0	486
10	0	483
11	0	476
12	0	483
13	0	488
14	0	490
MAXIMUM	0	495

 -----  
 CUSTOMER  
 .....  
 .  
 .  
 .....  
 APPLIANCE  
 .....  
 .  
 .  
 .....  
 REFERENCE  
 .....  
 .  
 .  
 .....

## 7. MEASURING GASES



After the countdown is finished and the analyser is correctly set up sampling can take place either by using a sampling tube/probe to reach into ducts or flues or simply by taking a direct ambient air measurement without a probe or hose connected.

**CAUTION:** Just by breathing you are emitting a relatively high level of CO<sub>2</sub> in the local area and this can affect the measurements. We do recommend that a probe or flexible hose is used so that the point where the ambient air is being sampled is at least 1 metre away from where anyone is breathing.

Make sure you do not exceed the operating specifications. In particular:

- Do not exceed the probe's maximum temperature (any plastic parts must not contact hot flues).
- Do not exceed the temperature operating range
- Do not put the analyser on a hot surface
- Do not exceed the water trap's levels
- Do not let the particle filter become dirty and blocked
- Ensure that the magnetic boot is free from metallic particles and any surfaces used when attaching the analyser are appropriate.

View data and rotate the dial to see changes as you make adjustments.

Press  first to hold or 'freeze' the readings before printing. Press  to print the results.

Before starting a test sequence it is recommended to check that the value for CO reads zero and CO<sub>2</sub> reads approximately 400ppm in fresh air.



## 8. EXAMPLE PRINTOUT IN AMBIENT AIR

The standard printouts are:

Instant print press 

```

KANE101 SW19477 V1.00
YOUR COMPANY NAME &
PHONE NUMBER HERE
SERIAL No.      052718005
LOG No.         03
DATE           21/08/18
TIME           08:33:05
-----
CAL DUE ON     01/08/19
-----
AMBIENT
-----
CO             ppm      0
CO2            ppm     688
CO AVERAGE    ppm      0
CO2 AVERAGE   ppm     493
CO MAXIMUM     ppm      0
CO2 MAXIMUM   ppm     888
-----
CUSTOMER
.....
:
:
:
.....
APPLIANCE
.....
:
:
:
.....
REFERENCE
.....
:
:
:
.....
    
```

Manually logged print  
via VIEW stored data

```

KANE101 SW19477 V1.00
YOUR COMPANY NAME &
PHONE NUMBER HERE
SERIAL No.      052718005
DATE           21/08/18
TIME           07:55:39
-----
CAL DUE ON     01/08/19
-----
AMBIENT
-----
CO             ppm      0
CO2            ppm     464
CO AVERAGE    ppm      0
CO2 AVERAGE   ppm     500
CO MAXIMUM     ppm      0
CO2 MAXIMUM   ppm     888
-----
CUSTOMER
.....
:
:
:
.....
APPLIANCE
.....
:
:
:
.....
REFERENCE
.....
:
:
:
.....
    
```

## 9. WHEN YOU FINISH USING THE ANALYSER

Always try to switch the analyser off in fresh air.

The analyser counts down from 5 before switch off with the pump running to self clean its sensors. If the measured CO level is more than 30 ppm do not switch off the analyser. It will need to sample fresh air until the CO level falls below 30 ppm. This extends the sensor's life and helps to eliminate any unwanted offset on next start-up.

## 10. MAINTENANCE

### 10.1 EMPTYING AND CLEANING THE INTEGRAL WATER TRAP

The water trap should be checked and emptied on a regular basis. Water vapour will condense in the probe line, which may cause the water trap to fill suddenly if the probe is moved. Care should be taken at all times.

Emptying of the water trap is detailed below: -

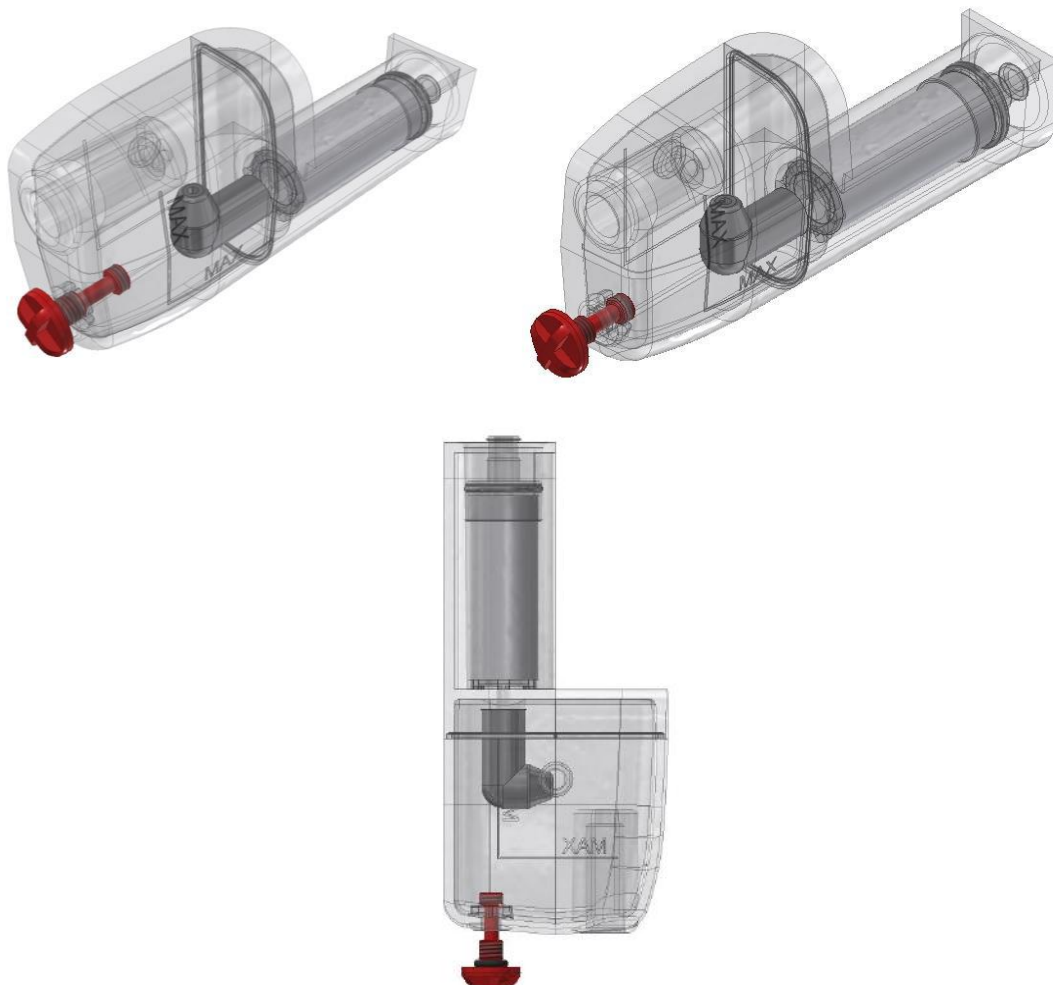

Carefully unscrew the red bung from the bottom of the water-trap housing. Dispose of the condensate in a suitable drain, care must be taken as it could be acidic.

If condensate spills onto the skin or clothing, clean off immediately using fresh water, seek medical advice if problems occur. Ensure the bung is replaced before performing further combustion tests.

## 10.2 CHANGING THE PARTICLE FILTER

This is a very important part of the analyser and should be changed regularly. It prevents dust and dirt particles from entering the pump and sensors that will cause damage. The filter **MUST** be changed when it appears discoloured.

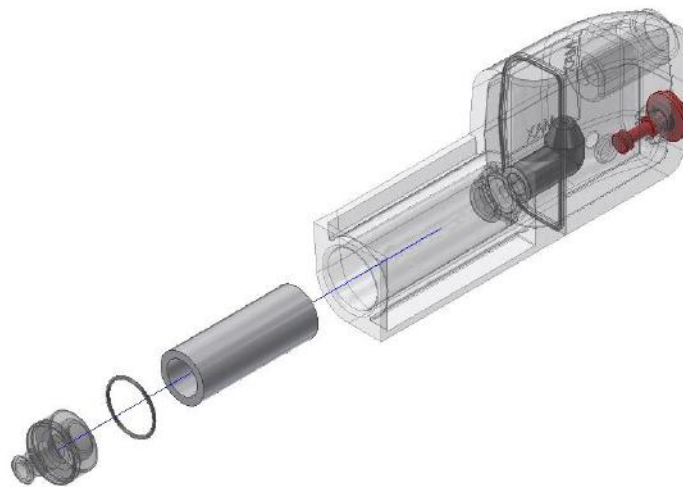

Remove water-trap assembly from the analyser as shown above. Remove the filter and plastic holder from the housing. Discard the filter element but keep the holder to fit to the new filter. Clean the inside of the filter housing with a suitable soft cloth. Fit the holder onto the new filter element and then insert into the housing. Refit the housing onto the analyser.



## 11. PROBLEM SOLVING

If any problems are not solved with these solutions, contact us or an authorised repair centre.

Fault symptom	Causes / Solutions
<ul style="list-style-type: none"><li>Batteries not holding charge.</li></ul>	<ul style="list-style-type: none"><li>Batteries exhausted.</li><li>AC charger not giving correct output.</li><li>Fuse blown in charger plug.</li></ul>
<ul style="list-style-type: none"><li>Analyser does not respond to gas</li></ul>	<ul style="list-style-type: none"><li>Particle filter blocked.</li><li>Probe or tubing blocked.</li><li>Pump not working or damaged with contaminants.</li><li>Water Trap Bung not fitting tightly.</li><li>Sensor fault</li></ul>

## TROUBLE SHOOTING

### *Display is totally clear or totally dark*

- Set the rotary dial to MENU switch on and leave unit for five minutes.
  - Press  $\triangle$  **three** times (listen for three beeps) then press  twice
  - Press  $\triangle$  repeatedly until the display becomes visible again (this can take up to 20 seconds). Use  $\triangle$  and  $\nabla$  to adjust the display's contrast.
  - Press  to accept.

### *The unit will not turn off.*

- Check the CO value is less than 30ppm

Press and hold 

## 12. KANE DASHBOARD



We really want you to register your Kane analyser at [www.kane.co.uk](http://www.kane.co.uk) to create your dashboard - your personal online analyser portal

Benefits include:



An automatic reminder when it's time to Service - Calibrate – Recertify



Our new simple online booking in procedure ensures you receive the fastest turnaround times possible



Easy access to your analyser's calibration certificates & service history



A record of your model & serial number with ability to report your analyser stolen



Product specific information & resources all in one place



Fixed service prices are always visible

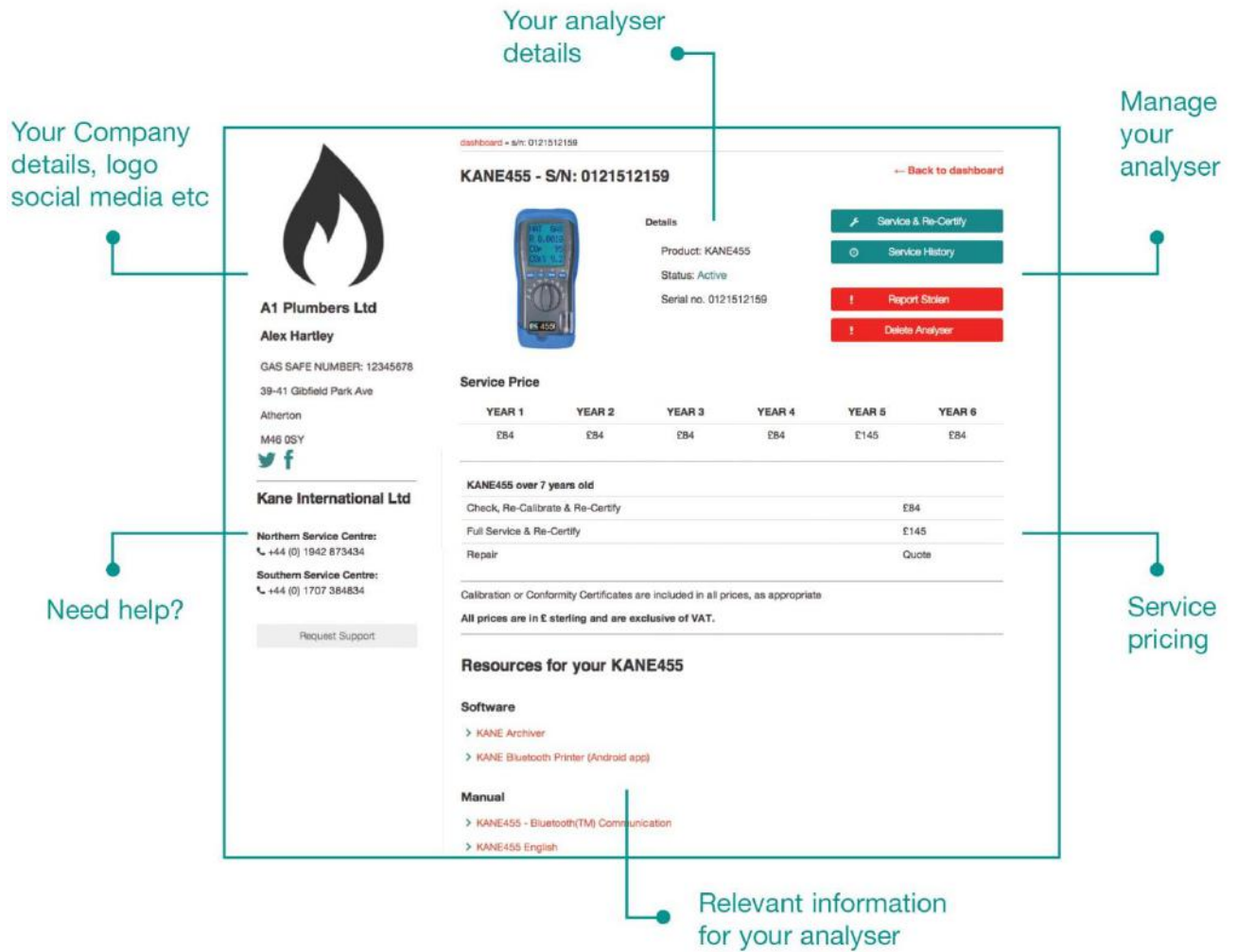



An out of calibration analyser may mean your combustion reports are invalid.

## 13. ONLINE BOOKING PROCEDURE @ [www.kane.co.uk](http://www.kane.co.uk)

To organise your Kane analyser's Service & Recertification online it must be registered.

To register, click 

If you have already registered, click  to sign in

From your dashboard, click  for the analyser you wish to organise Service & Recertification, then click  & follow our simple online booking process:

1. This page confirms if a service/recertification is required & how much it will cost

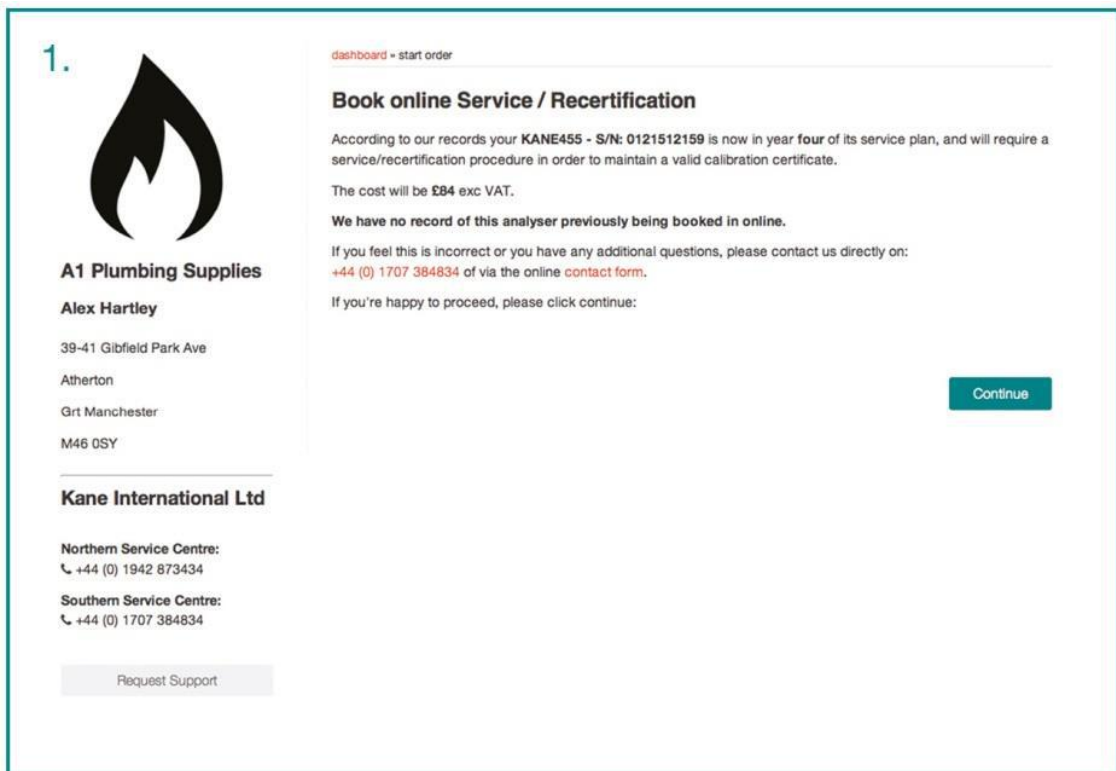

The screenshot shows a web page titled "Book online Service / Recertification". On the left, there is a logo of a flame and contact information for "A1 Plumbing Supplies" (Alex Hartley, 39-41 Gibfield Park Ave, Atherton, Grt Manchester, M46 0SY) and "Kane International Ltd" (Northern Service Centre: +44 (0) 1942 873434, Southern Service Centre: +44 (0) 1707 384834). A "Request Support" button is at the bottom left. The main content area has a breadcrumb "dashboard - start order" and the heading "Book online Service / Recertification". The text states: "According to our records your KANE455 - S/N: 0121512159 is now in year four of its service plan, and will require a service/recertification procedure in order to maintain a valid calibration certificate. The cost will be £84 exc VAT. We have no record of this analyser previously being booked in online. If you feel this is incorrect or you have any additional questions, please contact us directly on: +44 (0) 1707 384834 of via the online contact form. If you're happy to proceed, please click continue:". A "Continue" button is located at the bottom right of the main content area.



2. Book your service/recertification & order any additional spare parts you need

**2.**



**A1 Plumbing Ltd**  
Alex Hartley

GAS SAFE NUMBER: 12345678  
39-41 Gibfield Park Ave  
Atherton  
M46 0SY

[Twitter](#) [Facebook](#)

**Kane International Ltd**

Northern Service Centre:  
☎ +44 (0) 1942 873434

dashboard » start order » step 1 » step 2 » step 3

To add any spare parts for your analyser, select quantity required. If not, click next.



**ASP2KIT**  
£99.00  
Appliance Sampling Probe Kit - 3 Probes with Handle/Hose Assembly



**PF400-5 Filters**  
£15.00



**PRD1**  
£20.00

3. Once happy with your order just confirm & pay

**3.**



**A1 Plumbing Supplies**  
Alex Hartley

39-41 Gibfield Park Ave  
Atherton  
Grt Manchester  
M46 0SY

**Kane International Ltd**

Northern Service Centre:  
☎ +44 (0) 1942 873434

Southern Service Centre:  
☎ +44 (0) 1707 384834

Request Support

dashboard » start order » step 1 » step 2 » step 3

**Step 2 - Confirmation**

**Delivery Address**

**A1 Plumbing Supplies**  
39-41 Gibfield Park Ave  
Atherton  
Grt Manchester  
M46 0SY  
United Kingdom  
☎ 01942 873434

**Billing Address**

**A1 Plumbing Supplies**  
39-41 Gibfield Park Ave  
Atherton  
Grt Manchester  
M46 0SY  
United Kingdom  
☎ 01942 873434

[Change delivery/billing address](#)

Description	Quantity	Amount (per item)
KANE455 - 0121512159 Year four Service / Recertification We have no record of this analyser previously being booked in online.	1	£84.00
Service Centre: <b>Southern Service Centre</b>	(1 items)	£84.00 ex VAT <b>£100.80 inc VAT</b>

[Pay with Card](#)

## 4. See your order & print out the return to Kane label

4.



**A1 Plumbing Supplies**  
Alex Hartley  
39-41 Gibfield Park Ave  
Atherton  
Grt Manchester  
M46 0SY

---

**Kane International Ltd**  
Northern Service Centre:  
☎ +44 (0) 1942 873434  
Southern Service Centre:  
☎ +44 (0) 1707 384834

Request Support

dashboard » Order Summary

### Order Summary

Thanks for your order.

We've charged your Visa card ending 4242 the amount **£100.80** for 1 x Service / Recertification. The charge will appear on your bank statement as **KANE INTERNATIONAL LTD.**

Your RMA number/s is **54842**.

Please quote this number in any correspondence with us.

### So what's next?

1. **Print delivery label**

[Print Label](#)

If you don't have access to a printer please make sure you write the RMA number/s (54842) so that it's clearly visible on your container.

If you can't print this label immediately, it will always be available to print from the RMA payment history detail section [\[HERE\]](#).

2. **Package Analyser**

Securely pack analyser with probe, charger and any other products requiring our attention.

Once securely packed, please send back to the Kane Service Center address via your local post office or a courier company such as [myHermes](#) or [Collect+](#).

It is advisable to send the package by **Special Delivery** so that it is insured and traceable while in transit.

**Your analyser MUST be returned directly to Kane and not through a third party otherwise additional charges may apply.**

[Finish](#)



Don't forget to put the label on your package and send it to us

## **14. ANALYSER ANNUAL SERVICE & RE-CERTIFY**

Although sensor life is typically more than five years, the analyser should be serviced and re-certified annually to counter any long-term sensor or electronics drift or accidental damage.

Local regulations may require more frequent re-certification.

Kane International has service facilities at Atherton near Manchester Tel: 01942-873434 (the primary service centre for UK customers) and at Welwyn Garden City in Hertfordshire Tel: 01707-375550 (the primary service centre for non-UK customers).

By sending your analyser back to Kane for an annual fixed price service (check [www.kane.co.uk](http://www.kane.co.uk) for details) you have the opportunity to extend the warranty on your analyser to 5 years.

### **14.1 SERVICE - CALIBRATE - RECERTIFY**

**YOU CAN COUNT THE REASONS WHY ON ONE HAND!**

1. Fixed prices ensure you know the full cost of ownership before you buy.
2. Flue Gas Analysers will drift out of calibration over time – only Kane can adjust them back to the manufacturers' specification & return them as accurate as when they were purchased.
3. Analysers always seem to require a service when you need them most! Kane's two UK Service Centres pride themselves on their fast service turnaround times.
4. Every Kane analyser is returned with a fully traceable calibration certificate & another 12 months warranty. After 6 years, warranty becomes limited to replacement parts only.
5. In some cases an out-of-calibration analyser means any combustion reports you produce are invalid, so it is very important you get your analyser recertified

## KANE IS NOW THE UK'S LARGEST, FASTEST & MOST RELIABLE FGA AFTER SALES SERVICE PROVIDER

- ✓ Our Northern & Southern Service Centres are the UK's only locations authorized to Service - Calibrate - Recertify & Repair Kane analysers
- ✓ You can organise your Kane analyser's Service & Recertification online via your Dashboard on [www.kane.co.uk](http://www.kane.co.uk), send it or call us to arrange a pre-booked while-you-wait service, saving you time & potential lost revenue

We pride ourselves on our fast turnaround for a fixed price, which includes:

- Inspecting your analyser & accessories, testing its functionality & adjusting it to our original specification
  - Free software upgrades, where applicable
  - Parts & labour on these replaceable parts as required: CO & CO<sub>2</sub>/O<sub>2</sub> sensors, pump & battery
  - Parts not included are optionally fitted toxic cells, cases & probes
  - All internal tubing, water trap, particle & chemical filters
  - Recertifying to national standards & issuing a fully traceable calibration certificate to confirm your analyser's performance
  - A complimentary Service Pack comprising PF400/5 (pack of five) replacement filter elements, Thermal Printer Roll, Water Trap Plug & Probe Connector (RRP for filters & roll = £17.40)
  - Return carriage via Next Day delivery service (UK mainland only)
- ✓ Kane is the only UK manufacturer of hand-held gas analysers granted UKAS accreditation to ISO / IEC 17025:2005 for its Welwyn Garden City calibration laboratory, covering a range of gases, temperature & pressure. Kane is certified to ISO 9001, ISO 14001 & BS OHSAS 18001
  - ✓ Our Northern Service Centre offers service & repair for your other instruments, including: thermometers, pressure meters & multimeters

## **14.2 RETURNING YOUR ANALYSER TO KANE**

Before returning your analyser to Kane, please ensure that you enclose:

- RMA label if you have used our new simple online booking in process
- Your full contact details
- A daytime telephone number
- Details of faults you might have experienced
- Any relevant accessories (eg. probe, printer, adaptor & leak detectors).  
Any accessories that are returned will be checked

### **PACKING YOUR ANALYSER:**

When returning an analyser with its probe, please send them back in their carry bag. The bag should be put into a suitably sized box (approx. 45cm x 20cm x 23cm)

When only returning an analyser, use a container as big as a shoe box & pack out empty space with newspaper

Before sealing your package, please ensure you followed our procedure above & have clearly marked your box for the Kane Service Team

If you do not have an account with a courier company, take your package to your local Post Office – we recommend Special Delivery so that it is insured & traceable in transit

### **WHEN WE RECEIVE YOUR ANALYSER:**

Our Service Engineers will inspect the analyser & accessories. If you haven't booked in & paid online, they will confirm the total service cost.

Once accepted, the work will be carried out & on completion, returned to you by Next Day delivery service (UK mainland only)

## 14.3 WHERE TO SEND YOUR ANALYSER

Northern Customer Service  
Kane International Ltd  
Gibfield Park Avenue  
Atherton,  
Manchester  
M46 0SY, UK  
t: +44 (0) 1942 873434  
f: +44 (0) 1942 873558  
e: nservice@kane.co.uk

Southern & International Customer Service  
Kane International Ltd  
Kane House, 11 Bessemer Road  
Welwyn Garden City  
Hertfordshire  
AL7 1GF, UK  
t: +44 (0) 1707 384834  
f: +44 (0) 1707 384833  
e: sservice@kane.co.uk

## 15. COLD WEATHER PRECAUTIONS

It is important you keep your flue gas analyser in a warm place overnight

Electronic devices that become really cold, by being left in a vehicle overnight, suffer when taken into a warm room the next morning. Condensation may form which can affect the analyser's performance & cause permanent damage

Electrochemical sensors used in flue gas analysers can be affected by condensation or water being sucked into the analyser, as the small apertures on top of sensors can become blocked with water, stopping sensors seeing flue gas. When this happens, oxygen or carbon dioxide reading will display as "—" & sensors may be permanently damaged

If you think that your analyser is affected by condensation or water ingress, it may be possible to rectify the problem yourself. Simply leave the analyser running in a warm place, with the pump 'ON' sampling fresh air for a few hours (use mains adapter/battery charger if needed). If, after doing this, you still experience problems please contact our Service Centres.

## 16. SPECIFICATION

Parameter	Resolution	Accuracy*1	Specified Range	Over Range
<b>Gas Measurement</b>				
Carbon Monoxide	1 ppm	+/-3 ppm <20ppm +/-5ppm <100ppm +/-5% > 100ppm +/-10% >1000ppm	1000 ppm	2000ppm
Carbon Dioxide	1 ppm	+/-25ppm <500ppm +/-5% < 5000ppm +/-10% >5000ppm	0 to 5000 ppm	9999ppm
<b><u>OPTIONS</u></b>				
Ozone	0.01 ppm	+/- 0.1 ppm	2 ppm	5 ppm
Probe temp	0.1C	+/- 1C	-20C to +60C	
Probe humidity	0.1%	+/-5% abs	10 to 95% RH	
Probe airflow	0.1m/s	+/- 1 m/s	0.3 to 30 m/s	
<b>Dimensions</b>				
Weight		1kg / 2.2lb		
Handset		200mm / 7.9" x 45mm / 1.8" x 90mm / 3.5"		
<b>Ambient Operating Range</b>		+0°C to +45°C / 32-104°F 10% to 90% RH non- condensing		
<b>Battery Life</b>		6 hours from full charge and with pump on		
<b>Battery Charger (standard type trickle charger)</b>		Input: 100 - 240 V ac 50 - 60 Hz Output: 12V dc. @ 800 mA. Max.		
<b>Compatibility</b>		KANE LIVE Android printer App KANE WIRELESS Printer App IOS		

\*1 Using dry gases at STP with the instrument not subjected to sudden changes of temperature, position or severe vibration

## 17. ELECTROMAGNETIC COMPATIBILITY

European Council Directive 89/336/EEC requires electronic equipment not to generate electromagnetic disturbances exceeding defined levels and have adequate immunity levels for normal operation. Specific standards applicable to this analyser are stated below.

As there are electrical products in use pre-dating this Directive, and radio transmitting devices which may not be covered by this Directive, they may emit excess electromagnetic radiation levels and, occasionally, it may be appropriate to check the analyser before use by:

Use the normal start up sequence in the location where the analyser will be used.

Switch on all localized electrical equipment capable of causing interference.

Check all readings are as expected. A level of disturbance is acceptable.

If not acceptable, adjust the position to minimize interference or switch off, if possible, the offending equipment during your test.

At the time of writing this manual (October 2018) we are not aware of any field based situation where such interference has occurred and this advice is only given to satisfy the requirements of the Directive.

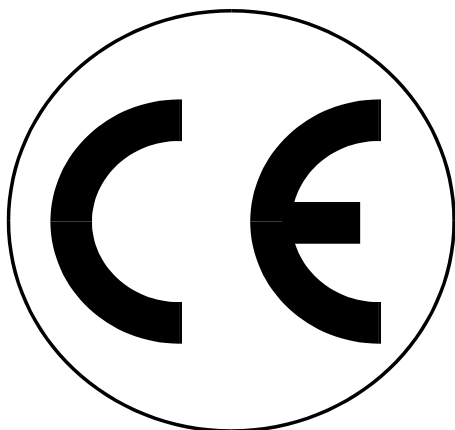

This product has been tested for compliance with the following generic standards:

EN 61000-6-3 : 2001

EN 61000-6-1 : 2001

and is certified to be compliant

Specification EC/EMC/KI/KANE 101 details the specific test configuration, performance and conditions of use.

### **Please Note:**

Batteries used in this instrument should be disposed of in accordance with current legislation and local guidelines.

At the end of the product's life it should be recycled in accordance with current legislation and local guidelines.



## APPENDIX

### Carbon Monoxide:

Current World Health Organisation recommended maximum exposure levels to Carbon Monoxide:

15 minutes	89ppm	≡	100mg/m <sup>3</sup>
30 minutes	53ppm	≡	60mg/m <sup>3</sup>
60 minutes	27ppm	≡	30mg/m <sup>3</sup>
8 hours	9ppm	≡	10mg/m <sup>3</sup>

### Carbon Dioxide:

British Standards BS6896, BS6230 and BS5990 confirm CO<sub>2</sub> concentration should not exceed 2800ppm where people are working.

HSE Regulation EH40 sets the maximum occupational exposure limit at 5000ppm.

BSRIA recommend a maximum of 800ppm over an eight hour time weighted average.

ASHRAE (62/99) recommends a maximum level of 1000ppm.

Data on ambient CO<sub>2</sub>:

NOAA observatory

(US. National Oceanic and Atmospheric Administration)

<http://www.cmdl.noaa.gov/ccgg/insitu.html>

<http://www.cmdl.noaa.gov/ccgg/iadv/>