

Multi-Port Globe Valve, Metal

Construction

The GEMÜ 352/354 pneumatically operated 3/2-way valve has a robust low maintenance plastic piston actuator. GEMÜ 352 is flanged, GEMÜ 354 has threaded sockets. The connection for the control medium can be rotated through 360°. The double sided valve plug is connected to the actuator via a valve spindle. The valve spindle is sealed by a self-adjusting gland packing providing low maintenance and reliable valve spindle sealing even after a long service life. A wiper ring fitted in front of the gland packing protects it against contamination and damage.

Features

- Suitable for inert liquid and gaseous media
- Control medium: inert gases
- Suitable for high working medium temperatures
- With GEMÜ 352 and GEMÜ 354 valves control processes which normally require two separate valves can be combined, for example: mixing, separating, aerating and de-aerating.
- Versions according to ATEX on request

Advantages

- Extensive range of accessories

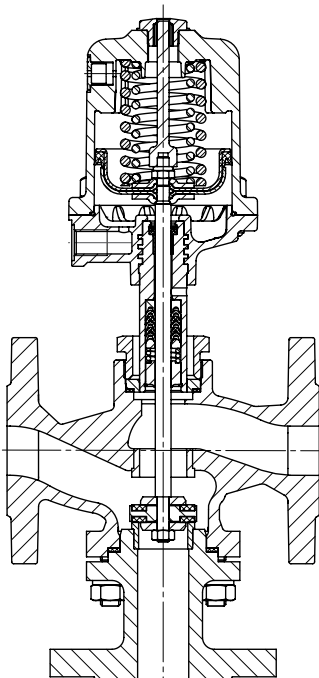
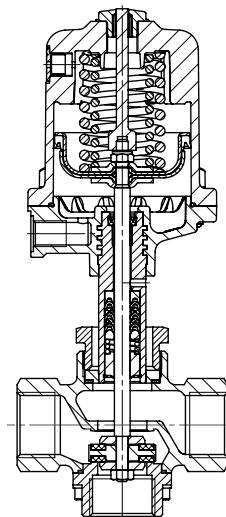
GEMÜ 352**GEMÜ 354**

Technical data

Working medium	
Inert gaseous and liquid media which have no negative impact on the physical and chemical properties of the body and seal material.	
Permissible pressure of working medium: see table below	
Media temperature	-10° to 180° C

Control medium	
Inert gaseous media	
Control pressure	see table below
Max. perm. temperature of control medium	60° C
Filling volume Actuator 1	0.125 dm ³
Actuator 2	0.625 dm ³

Ambient conditions	
Ambient temperature	max. 60° C

Maximum permissible seat leakage rate

Seat seal	Standard	Test procedure	Leakage rate	Test medium
PTFE	DIN EN 12266-1	P12	A	Air

352	Control function 1					Control function 2					
	Maximum operating pressure			Control pressure		Maximum operating pressure			Control pressure		
	B - AB		A - AB	Actuator 1	Actuator 2	A - AB		B - AB	Actuator 1	Actuator 2	
DN	Actuator 1	Actuator 2		See operating pressure/ control pressure diagram		Actuator 1	Actuator 2		See operating pressure/ control pressure diagram		
15	16.0	-	See operating pressure/ control pressure diagram	5.5 - 7.0	-	16.0	-	See operating pressure/ control pressure diagram	3.0 - 7.0	-	
20	16.0	-		5.5 - 7.0	-	11.7	-		3.0 - 7.0	-	
25	10.0	-		5.5 - 7.0	-	7.5	-		3.0 - 7.0	-	
32	6.0	16.0		5.5 - 7.0	4.0 - 7.0	-	16.0		-	3.0 - 7.0	-
40	4.5	14.0		5.5 - 7.0	4.0 - 7.0	-	11.1		-	3.0 - 7.0	-
50	2.5	10.0		5.5 - 7.0	4.0 - 7.0	-	7.2		-	3.0 - 7.0	-
65	-	7.0		-	5.5 - 7.0	-	4.2		-	3.0 - 7.0	-
80	-	4.0		-	5.0 - 7.0	-	2.6		-	3.0 - 7.0	-
100	-	2.0	-	5.0 - 7.0	-	-	-	-	-		

354	Control function 1					Control function 2					
	Maximum operating pressure			Control pressure		Maximum operating pressure			Control pressure		
	P - A		R - A	Actuator 1	Actuator 2	R - A		P - A	Actuator 1	Actuator 2	
DN	Actuator 1	Actuator 2		See operating pressure/ control pressure diagram		Actuator 1	Actuator 2		See operating pressure/ control pressure diagram		
15	16.0	-	See operating pressure/ control pressure diagram	5.5 - 7.0	-	16.0	-	See operating pressure/ control pressure diagram	3.0 - 7.0	-	
20	16.0	-		5.5 - 7.0	-	13.7	-		3.0 - 7.0	-	
25	10.0	-		5.5 - 7.0	-	9.2	-		3.0 - 7.0	-	
32	6.0	16.0		5.5 - 7.0	4.0 - 7.0	-	11.2		-	3.0 - 7.0	-
40	4.5	14.0		5.5 - 7.0	4.0 - 7.0	-	7.1		-	3.0 - 7.0	-
50	2.5	10.0		5.5 - 7.0	4.0 - 7.0	-	-		-	3.0 - 7.0	-

DN	GEMÜ 352				GEMÜ 354			
	Kv values [m ³ /h]		Weight [kg]		Kv values [m ³ /h]		Weight [kg]	
	B - AB	AB - A	Actuator 1	Actuator 2	P - A	A - R	Actuator 1	Actuator 2
15	6.0	4.2	4.4	-	3.6	2.5	1.7	-
20	12.0	7.1	5.8	-	5.5	3.3	1.8	-
25	18.5	12.7	6.7	-	10.6	7.3	2.1	-
32	26.0	15.0	10.4	13.3	18.0	10.4	3.2	6.1
40	40.0	27.0	11.5	14.5	31.0	20.9	3.7	6.7
50	60.0	43.0	15.3	18.4	47.0	33.7	4.7	7.9
65	104.0	68.0	-	25.5	-	-	-	-
80	145.0	96.0	-	32.0	-	-	-	-
100	220.0	144.0	-	44.0	-	-	-	-

Kv values determined acc. to DIN EN 60534 standard, valve body material cast iron EN-GJL-250 with connection flange EN 1092, valve body material cast bronze with threaded socket connection DIN ISO 228. The Kv value data refers to control function 1 (NC) and the largest actuator for each nominal size. The Kv values for other product configurations (e.g. other connection types or body materials) may differ.

Pressure / temperature correlation for globe valve bodies

Connection code	Material code	Max. allowable operating pressures in bar at temperature in °C *			
		RT	100	150	200
1	9	16.0	16.0	16.0	13.5
8	37	16.0	16.0	14.5	13.4
11	37	40.0	40.0	36.3	33.7
39	37	19.0	16.0	14.8	13.6

* The valves can be used down to -10 °C

RT = room temperature

All pressures are gauge pressures.

Functions

GEMÜ 352 Distribution

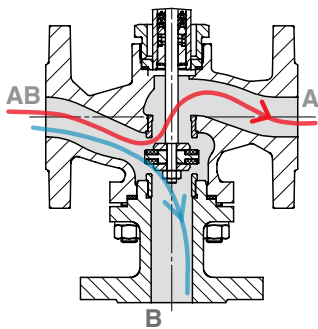

A - R
A - P

GEMÜ 354 Distribution

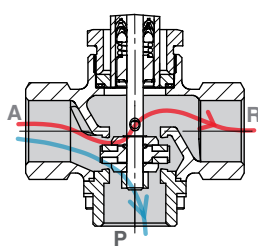

A - R
A - P

GEMÜ 352 Mixing

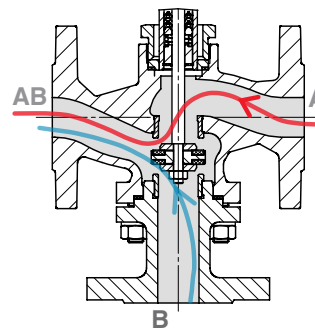

R - A
P - A

GEMÜ 354 Mixing

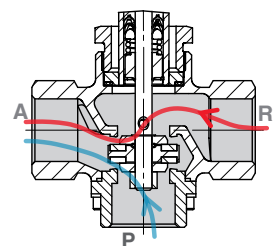

R - A
P - A

Technical data

Operating pressure / Control pressure characteristics

352 C.f. 1 / Actuator size 1 (flow direction A - AB)

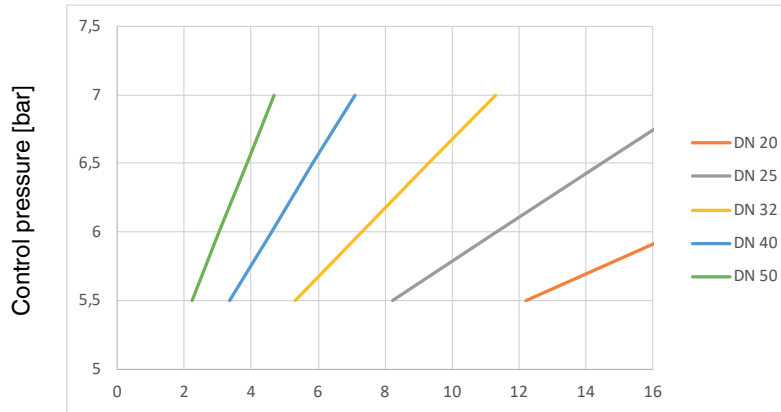

Operating pressure [bar]

DN 15: a control pressure of 5.5 bar is required for an operating pressure up to 16 bar.

352 C.f. 1 / Actuator size 2 (flow direction A - AB)

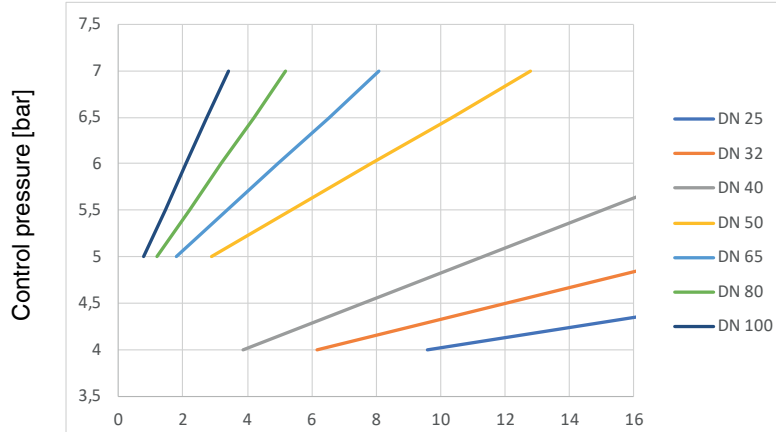

Operating pressure [bar]

DN 15: a control pressure of 5.5 bar is required for an operating pressure up to 16 bar.

352 C.f. 2 / Actuator size 1 (flow direction B - AB)

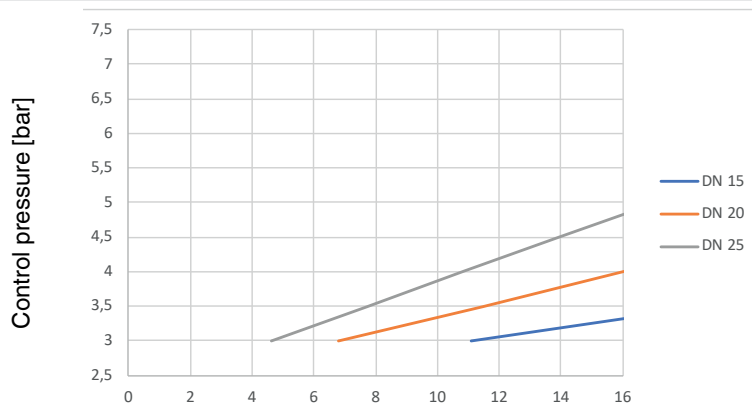

Operating pressure [bar]

DN 15: a control pressure of 5.5 bar is required for an operating pressure up to 16 bar.

Technical data

Operating pressure / Control pressure characteristics

352 C.f. 2 / Actuator size 2 (flow direction B - AB)

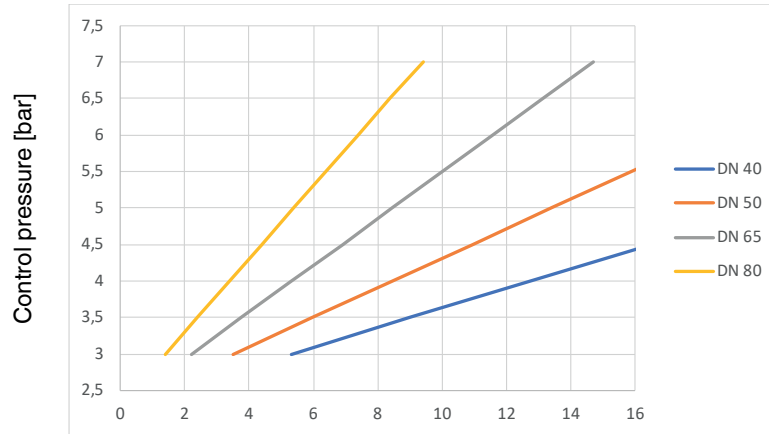

Operating pressure [bar]

DN 15: a control pressure of 5.5 bar is required for an operating pressure up to 16 bar.

354 C.f. 1 / Actuator size 1 (flow direction R - A)

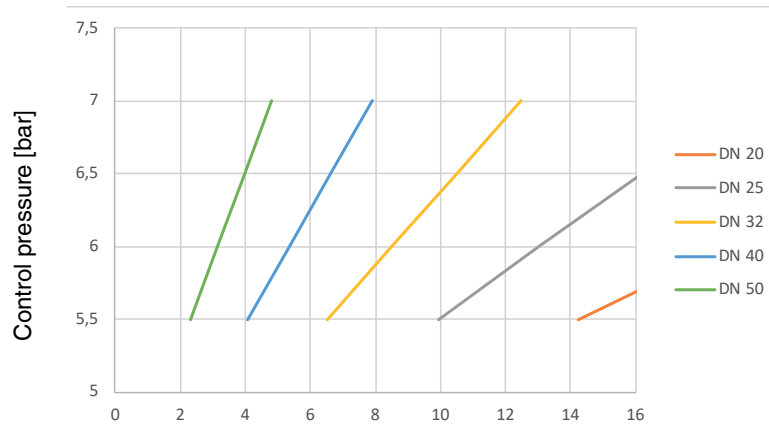

Operating pressure [bar]

DN 15: a control pressure of 5.5 bar is required for an operating pressure up to 16 bar.

354 C.f. 1 / Actuator size 2 (flow direction R - A)

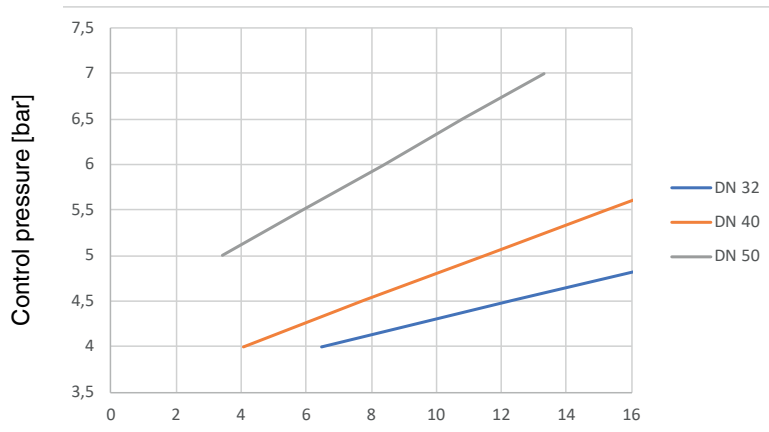

Operating pressure [bar]

DN 15: a control pressure of 5.5 bar is required for an operating pressure up to 16 bar.

Technical data

Operating pressure / Control pressure characteristics

354 C.f. 2 / Actuator size 1 (flow direction P - A)

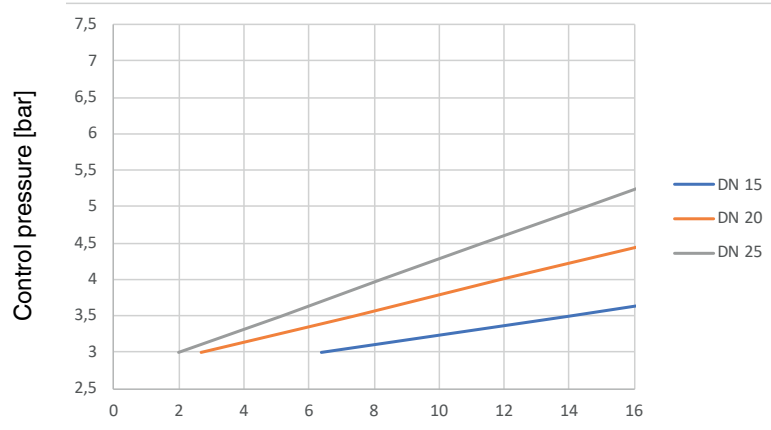

Operating pressure [bar]

DN 15: a control pressure of 5.5 bar is required for an operating pressure up to 16 bar.

354 C.f. 2 / Actuator size 2 (flow direction P - A)

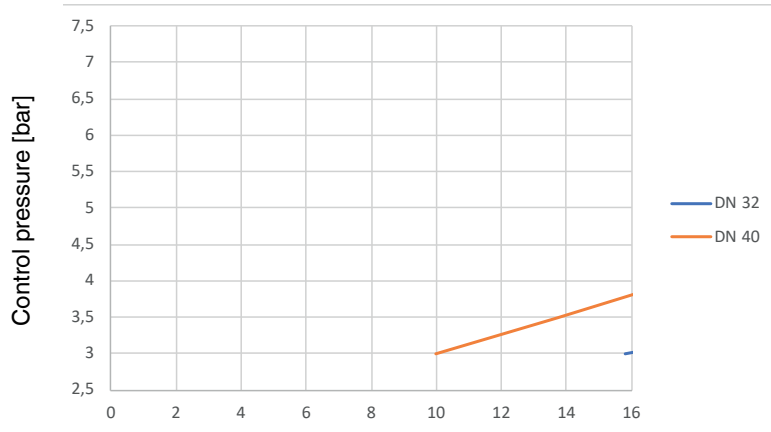

Operating pressure [bar]

DN 15: a control pressure of 5.5 bar is required for an operating pressure up to 16 bar.

Order data

Body configuration	Code
Multi-port	M

Seat seal	Code
PTFE	5
PTFE, glass fibre reinforced	5G

Connection type	Code
Threaded socket DIN ISO 228 (GEMÜ 354)	1
Flanges EN 1092 PN 16 // form B, length EN 558, series 1, ISO 5752, basic series 1 (GEMÜ 352)	8
Flanges EN 1092 / PN40 / form B, length EN 558, series 1 ISO 5752, basic series 1 (GEMÜ 352)	11
Flanges ANSI Class 150 RF, face-to-face dimension FTF EN 558 series 1, ISO 5752, basic series 1	39

Control function	Code
Normally closed (NC)	1
Other control functions on request	

Actuator size	Code
Actuator 1 piston ø 70 mm	1
Actuator 2 piston ø 120 mm	2

Valve body material	Code
GEMÜ 352: 1.4408, investment casting	37
GEMÜ 354: (Rg 5) CC499K, cast bronze	9

Note
Other designs on request.

Order example	352	20	M	11	37	5	1	1
Type	352							
Nominal size		20						
Body configuration (code)			M					
Connection type (code)				11				
Valve body material (code)					37			
Seat seal (code)						5		
Control function (code)							1	
Actuator size (code)								1

Dimensions - GEMÜ 352 [mm]

Actuator dimensions

	$\varnothing B$	M	A2	G
Actuator size 1	96	M16 x 1	86	G 1/4
Actuator size 2	168	M22 x 1.5	149	G 1/4

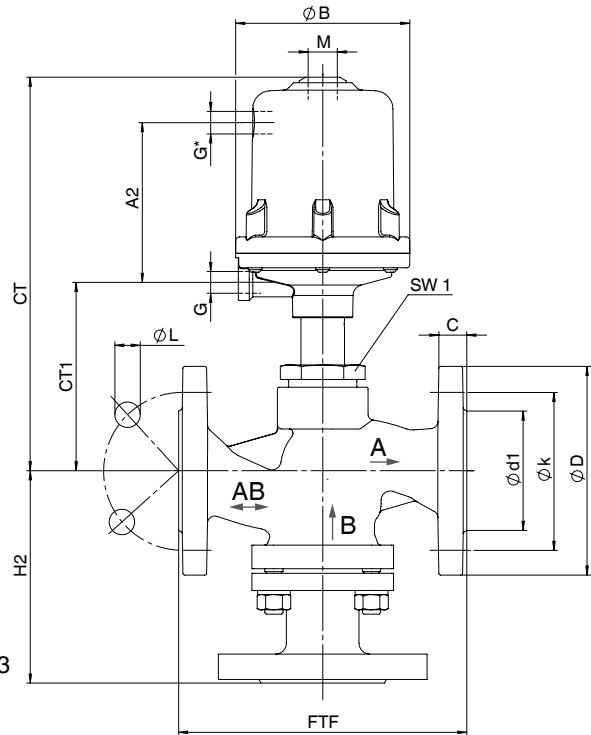

Body dimensions / Installation dimensions

Flange - DIN EN 1092, connection code 8, 11 Valve body material: 1.4408 (code 37)

DN	FTF	$\varnothing D$	$\varnothing k$	$\varnothing L$	Number of bolts	SW1	$\varnothing d1$	C	H2	Actuator 1		Actuator 2	
										CT	CT1	CT	CT1
15	130	95	65	14	4	41	45	16	97	210	104	-	-
20	150	105	75	14	4	41	58	18	112	215	109	-	-
25	160	115	85	14	4	41	68	18	118	216	110	-	-
32	180	140	100	18	4	41	78	18	143	226	120	321	145
40	200	150	110	18	4	41	88	18	147	235	129	330	154
50	230	165	125	18	4	41	102	20	167	242	136	337	161
65	290	185	145	18	4	55	122	20	183	-	-	349	173
80	310	200	160	18	8	55	138	22	204	-	-	361	185
100	350	220	180	18	8	55	158	24	236	-	-	375	199

Flange - ANSI Class 125/150 RF, connection code 39 Valve body material: 1.4408 (code 37)

DN	FTF	$\varnothing D$	$\varnothing k$	$\varnothing L$	Number of bolts	SW1	$\varnothing d1$	C	H2	Actuator 1		Actuator 2	
										CT	CT1	CT	CT1
15	130	90	60.3	15.9	4	41	34.9	16	97	210	104	-	-
20	150	100	69.9	15.9	4	41	42.9	18	112	215	109	-	-
25	160	110	79.4	15.9	4	41	50.8	18	118	216	110	-	-
32	180	115	88.9	15.9	4	41	63.5	18	143	226	120	321	145
40	200	125	98.4	15.9	4	41	73.0	18	147	235	129	330	154
50	230	150	120.7	19.0	4	41	92.1	20	167	242	136	337	161
65	290	180	139.7	19.0	4	55	104.6	23	183	-	-	349	173
80	310	190	152.4	19.0	4	55	127.0	24	204	-	-	361	185
100	350	230	190.5	19.0	8	55	157.2	24	236	-	-	375	199

Dimensions - GEMÜ 354 [mm]

Actuator dimensions

	$\varnothing B$	M	A2	G
Actuator size 1	96	M16 x 1	86	G 1/4
Actuator size 2	168	M22 x 1.5	149	G 1/4

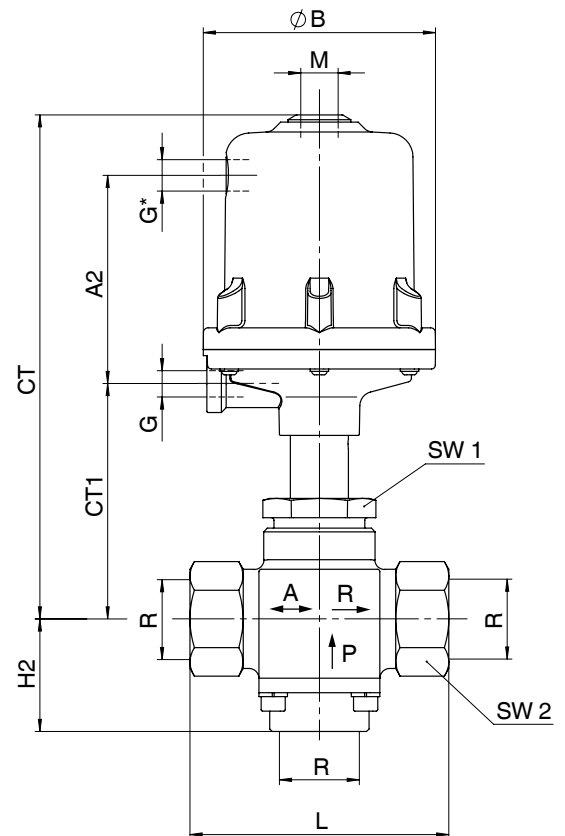

*Connection only for control functions 2 and 3

Body dimensions / Installation dimensions

Threaded socket, connection code 1
Valve body material: Cast bronze (code 9)

DN	R	L	SW1	SW2	H2	Actuator 1		Actuator 1	
						CT	CT1	CT	CT1
15	G 1/2	75	36	27	41	203	97	-	-
20	G 3/4	87	36	32	46	207	101	-	-
25	G 1	107	41	41	47	207	101	-	-
32	G 1 1/4	123	55	50	66	211	105	306	130
40	G 1 1/2	147	55	58	68	211	105	306	130
50	G 2	171	55	70	74	215	109	310	134

Overview of valve bodies - GEMÜ 352, 354

Connection code	1 (GEMÜ 354)	8 (GEMÜ 352)	11 (GEMÜ 352)	39 (GEMÜ 352)
Material code	9	37	37	37
DN 15	X	-	X	X
DN 20	X	-	X	X
DN 25	X	-	X	X
DN 32	X	-	X	X
DN 40	X	-	X	X
DN 50	X	-	X	X
DN 65	-	X	-	-
DN 80	-	X	-	-
DN 100	-	X	-	-

All rights including copyright and industrial property rights are expressly reserved.

Other multi-port valves



GEMÜ 312 / 314



GEMÜ 343

Should there be any doubts or misunderstandings, the German version of this data sheet is the authoritative document!

Subject to alteration · 10/2020 · 88310469

GEMÜ

